



GENERAL CATALOGUE

2K19V.01



Service & Garage Equipments



Servis & Garaj Ekipmanları

HISTORY / TARİHÇE

Atek Makina Merkez Binası
Esenyurt / İST.



Atek Merkez Fabrikası
Hadımköy / İST.



Atek Lift Merkez Binası
Esenyurt / İST.



Atek family, immigrated from Bulgaria to İstanbul in 1950 and Grandfather "Mustafa Keser" established the company in 1954. At the early ages the company started producing Automotive supplier industry products slowly. After Granfather' s death, their mother Hatice Keser and his sons "Altan, Turhan, Ertan Keser" took the necessary educations and struggled to improve the company.

Today ATEK MAKİNA SAN. ve T.C. A.Ş. produces latest technology machines and equipments by latest tecnology at world standarts with its research and development (R&D) Department and Certificates of ISO 9001, CE, ISO 16949, TSE, TSEK, GOST at the modern factory in Hadımköy –İstanbul. ATEK MAKİNA SAN. ve T.C. A.Ş. makes sales, marketing and makes distribution by mobile sales vehicles for its products, distributed products at the 4000 m2 store in Kiraç İstanbul. It has started the new investment under Atek Group constitut on and under name of "ATEK LİFT Hydraulic Lifting Systems". Atek Makina produces lift which prov ides latest technology, performance, safety and durability by its experience, experienced engineers and designers.

ATEK LİFT provides large product range for different types of vehicles and increasing life expectations it also gives technical service formaintenance and repair. Furthermore Atek's Branch is in Plovdiv-Bulgaria, was established in 2001. Besides that there is also mobile sales vehicles network in Bulgaria. Also Atek has got an investment at Tourism and Hotel Field, there is a Hotel in Plovdiv which is expected opening in 2012 and called "City Hotel Plovdiv" that the city of Plovdiv as a fair value and the enriched region. Presently ATEK MAKİNA SAN. ve T.C. A.Ş. proudly exports its products directly and indirectly at 121 points in 82 countr es.

Atek Ailesi, 1950 yılında Bulgaristan'dan göç ederek İstanbul'a yerleşmiş ve 1954 yılında büyük baba "Mustafa Keser" tarafından kurulmuştur. Başlangıçta otomotiv yan sanayi ve küçük çapta üretimler yaparak işe devam ederken 1964 yılında büyük babanın vefatı ile anneler Hatice Keser ve oğulları "Altan, Turhan, Ertan Keser" gerekl eğitimleri alarak firmayı geliştirmek için mücadele etmişlerdir.

Bugün ATEK MAKİNA SAN. VE TİC. A.Ş., İstanbul-Hadımköy'dek, modern fabrikasında son sistem makina ve ekipmanları, bünyesindeki özerk Ar-ge departmanı ile, ISO 9001, CE, İSO 16949, TSE, TSEK, GOST belgeleriyle dünya standartlarında ve en ileri teknolojiyle üretim yapmaktadır. ATEK MAKİNA SAN. VE TİC. A.Ş., İstanbul - Kiraç'tak 4000 metrekarelik mağazasında, üretmiş olduğu makinalarının ve mümess li olduğu ürünlerin satışını, pazarlamasını,ve gezici araçlarıyla dağıtımını yapmaktadır.

ATEK LİFT, hidrolik konusundaki engin deneyimiyle, mühendis ve tasarımcılarıyla en iyi teknoloji, performans, güvenlik ve dayanıklılık kombinasyonunu sunacak lift üretimler yapmaktadır. ATEK LİFT, farklı araç özellikler ve artan yaşam beklentileri için, geniş bir ürün yelpazesıyla faal yet gösterirken, aynı zamanda bakım ve onarımlar için teknik servis hizmeti vermektedir. Buna paralel olarak 2001 yılında ürün çeşitlerini Bulgaristan'ın Plovdiv şehrinde açtığı mağazada ve gezici satış araçları ağı ile Bulgaristan piyasasına sunmaktadır. Ayrıca Bulgaristan'da Turizm ve Otelcilik sektöründe 2012 yılında hizmete giren City Hotel Plovdiv, bir fuar bölgesi olan Plovdiv şehrine de bir değer ve zenginlik katmıştır. Şu anda ATEK MAKİNA SAN. VE TİC. A.Ş. mamüllerini direkt ve endirekt olarak 82 ülkede 121 satış noktasına gururla ihraç etmektedir.

City Hotel Plovdiv
Plovdiv / Bulgaristan



Atek Fabrika Ek Binası
Hadımköy / İST.



Atek Showroom
Plovdiv / Bulgaristan



RIM REPAIR SYSTEMS 02
JANT DÜZELTME SİSTEMLERİ

TYRE CHANGER SYSTEMS 10
LASTİK SÖKME-TAKMA SİSTEMLERİ

LIFTING SYSTEMS 22
ARAÇ KALDIRMA / LİFT SİSTEMLERİ

NITROGENS 24
NİTROJENLER

ROAD SIMULATOR & RIM PAINTER 25
YOL SİMÜLATÖRÜ VE JANT BOYAMA

ATEK JACKS 26
ATEK KRİKOLAR

ATEK TAIL LIFTS 28
ATEK KAMYON ARKASI KAPAK LİFTLERİ

MARUNI TYRE REPAIR PATCHS 30
MARUNI LASTİK TAMİR YAMALARI

UNITROL BALANCING 33
UNITROL BALANS

FASEP BALANCING 34
FASEP BALANS

TROLLEY JACKS 36
ARABALI KRİKOLAR

37 COMPRESSORS
KOMPRESÖRLER

40 TYRE INFLATORS
HAVA SAATLERİ

42 IMPACT WRENCHES
BİJON TABANICALARI

44 VALVES
SİBOPLAR

45 HOFMANN WHEEL WEIGHTS
HOFMANN BALANS KURŞUNLARI

47 CORGHI TYRE CHANGERS
CORGHI LASTİK SÖKME-TAKMA

55 CORGHI BALANCING
CORGHI BALANS

59 CORGHI ALIGNMENT
CORGHI ROT

64 CORGHI LIFTS
CORGHI LİFTLERİ

68 CORGHI TEST EQUIPMENTS
CORGHI TEST EKİPMANLARI

72 CORGHI AIR CONDITIONING
CORGHI KLİMA DOLUM VE TEST



TSEK

NEW
PRODUCT
YENİ
ÜRÜN



PATENTED
BY ATEK



12"-28"



lathe



gear box / redüktör



2045x1045x2100mm



Standard 24V DC

WEIGHT
Ağırlık
KG
1130

GALILEO 12"-28"

kod. 40 00 CE

- 7" Touch Screen Full-Automatic Rim Straightener
 - Digital measuring
- Vertical and horizontal measuring at the same time
 - Two pcs Multiangular pressing heads
 - Special and strong **Roll-Heads**
 - Joystick control
 - Locking Systems
 - Automatic rim speed control
- New generation lathe (turning & moving)
 - Powerful planetary gearbox
 - Rim rotating speed 5-98 rpm
- 7" Dokunmatik ekranlı tam otomatik jant düzeltme makinası
 - Dijital ölçüm
 - Aynı anda dikey ve yatay ölçüm
- İki adet çok yönlü dayama ayağı ve rollerli jant düzeltme
 - **Roll-Head** roller sistemli düzeltme
 - Joystick kontrolü
 - Kilitleme sistemi
 - Yeni jenerasyon torna (kayar ve döner tip)
 - Otomatik jant hız kontrolü
 - Güçlü planet redüktörü
 - Jant Dönüş hızı 5-98 rpm



PATENTED
BY ATEK



12"-28"



lathe



gear box / redüktör



2045x1045x2100mm



Standard 24V DC

WEIGHT
Ağırlık
KG
940

PANGEA 12"-28"

kod.36 00 CE

- Full automatic rim repair
 - Digital measuring
- Vertical and horizontal measuring at the same time
 - Two pcs Multiangular pressing heads
 - Joystick control
 - Electronic rotate control
 - New generation lathe (turning & moving)
 - Gearbox
 - Optional **QuickClamp** System
 - Rim rotating speed 5-98 rpm
 - Net weight 940 kg
 - Full otomatik jant düzeltme
 - Dijital ölçüm
 - Aynı anda dikey ve yatay ölçüm
 - İki adet çok yönlü dayama ayağı
 - Joystick kontrolü
 - Yeni jenerasyon torna (kayar ve döner tip)
 - Elektronik hız kontrolü
 - Redüktörü
 - Opsiyonel **QuickClamp** hızlı jant bağlama sistemi
 - Jant Dönüş hızı 5-98 rpm
 - Net ağırlık 940 kg



Optional **QuickClamp** System
Opsiyonel **QuickClamp** hızlı jant bağlama sistemi

Optional parts used in this image
Bu görselde opsiyonel parçalar kullanılmıştır.



Servis & Garaj Ekipmanları

DIGITAL 10"-26"

kod.56 00 CE

- Full automatic rim straightener
- Digital measuring
- Multifunction support positions
- Joystick control
- Electronic rotate control
- Moving lathe
- Gearbox
- Optional **QuickClamp**
- Rim rotating speed 5-98 rpm
- Net weight 720 kg
- Full otomatik jant düzeltme
- Dijital ölçüm
- Çok yönlü dayama ayağı
- Joystick kontrolü
- Kayar tip toma
- Elektronik hız kontrolü
- Redüktörlü
- Opsiyonel **QuickClamp** hızlı jant bağlama sistemi
- Jant Dönüş hızı 5-98 rpm
- Net ağırlık 720 kg



10"-26"



lathe



gear box / redüktör



2045x1045x2100mm



Standard 24V DC

WEIGHT
Ağırlık
KG
720



BASIC 10"-26"

kod.62 00 CE

- Full automatic rim straightener
- Multifunction support positions
- Joystick control
- Electronic rotate control
- Moving lathe
- Gearbox
- Optional **QuickClamp**
- Rim rotating speed 5-98 rpm
- Net weight 710 kg
- Full otomatik jant düzeltme
- Çok yönlü dayama ayağı
- Joystick kontrolü
- Kayar tip toma
- Elektronik hız kontrolü
- Redüktörlü
- Opsiyonel **QuickClamp** hızlı jant bağlama sistemi
- Jant Dönüş hızı 5-98 rpm
- Net ağırlık 710 kg



10"-26"



lathe



gear box / redüktör



2045x1045x2100mm



Standard 24V DC

WEIGHT
Ağırlık
KG
710



Single phase motor is optional for all products in this page.
Yukarıdaki tüm ürünlerde monofaze motor seçeneği opsiyoneldir.



TSEK

RIM REPAIR SYSTEMS JANT DÜZELTME SİSTEMLERİ



10"-26"



1554x1032x1853mm



lathe



bridge s. / köprülü d.



84R 00 g.box / r.tör



84 00 V-belt / kasnak

JUMBO DOUBLE 10"-26"

kod.84 00 / 84R 00

- Rim repair with double pistons
- New generation lathe (turning & moving)
- New generation bridge support kit
 - V-belt (code 84 00)
 - Gear box (code 84R 00)
- Rim rotating speed 250 rpm (code 84 00)
- Rim rotating speed 98 rpm (code 84R 00)
 - Net weight 455 kg
 - Çift pistonlu jant düzeltme
- Yeni jenerasyon torna (kayar ve döner tip)
 - Yeni jenerasyon köprülü dayama kiti
 - Kasnaklı (kod 84 00)
 - Redüktörlü (kod 84R 00)
- Jant Dönüş hızı 250 rpm (kod 84 00)
- Jant Dönüş hızı 98 rpm (kod 84R 00)
 - Net ağırlık 455 kg



10"-24"



1198x972x1710mm



lathe



bridge s. / köprülü d.



86R 00 g.box / r.tör



86 00 V-belt / kasnak

NEW LINE 86/86R 00 10"-24"

kod.86 00 / 86R 00

- New generation lathe (turning & moving)
- Bridge support kit
 - V-belt (code 86 00)
 - Gear box (code 86R 00)
- Rim rotating speed 250 rpm (code 86 00)
- Rim rotating speed 98 rpm (code 86R 00)
 - Net weight 390 kg
 - Yeni jenerasyon torna (kayar ve döner tip)
 - Köprülü dayama kiti
 - Kasnaklı (kod 86 00)
 - Redüktörlü (kod 86R 00)
 - Jant Dönüş hızı 250 rpm (kod 86 00)
 - Jant Dönüş hızı 98 rpm (kod 86R 00)
 - Net ağırlık 390 kg



10"-24"



lathe



V-belt / kasnak



b.support / büyük d.



1198x972x1710mm

NEW LINE 87 00 10"-24"

kod.87 00

- New generation lathe (turning & moving)
- Standart big support kit
- Optional bridge support kit
 - V-belt
- Rim rotating speed 250 rpm
 - Net weight 365 kg
- Yeni jenerasyon torna (kayar ve döner tip)
 - Standart büyük dayama kiti
 - Opsiyonel köprülü dayama kiti
 - Kasnaklı
 - Jant Dönüş hızı 250 rpm
 - Net ağırlık 365 kg

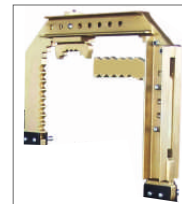

kod. 23 24 000
Optional Bridge Support Kit
Opsiyonel Köprülü dayama kiti



Servis & Garaj Ekipmanları

Single phase or 24V DC motor is optional for all products in this page.

Yukarıdaki tüm ürünlerde monofaze motor seçeneği yada 24V DC motor seçeneği opsiyoneldir.

JUMBO 10"-24"

kod.23 00

- Moving lathe
- Big support kit
- Optional bridge support kit
- Gear box
- Rim rotating speed 98 rpm
- Net weight 330 kg
- Kayar tip toma
- Büyük dayama kit
- Opsiyonel köprülü dayama kit
- Redüktörlü
- Jant Dönüş hızı 98 rpm
- Net ağırlık 330 kg



kod. 23 24 000

Optional Bridge Support Kit
Opsiyonel Köprülü dayama kit



10"-24"



lathe



b.support / büyük d.



gear box / redüktör



1425x912x1653mm



JUMBO K 10"-24"

kod.23K 00

- Moving lathe
- Bridge support kit
- Gear box
- Rim rotating speed 98 rpm
- Net weight 365 kg
- Kayar tip toma
- Köprülü dayama kit
- Redüktörlü
- Jant Dönüş hızı 98 rpm
- Net ağırlık 365 kg



10"-24"



lathe



gear box / redüktör



bridge s. / köprülü d.



1425x912x1800mm



55K 00 10"-24"

kod.55K 00

- Moving lathe
- Bridge support kit
- Gear box
- Rim rotating speed 98 rpm
- Net weight 370 kg
- Kayar tip toma
- Köprülü dayama kit
- Redüktörlü
- Jant Dönüş hızı 98 rpm
- Net ağırlık 370 kg



10"-24"



lathe



gear box / redüktör



bridge s. / köprülü d.



1198x972x1710mm



Single phase or 24V DC motor is optional for all products in this page.
Yukarıdaki tüm ürünlerde monofaze motor seçeneği yada 24V DC motor seçeneği opsiyoneldir.



TSEK

RIM REPAIR SYSTEMS JANT DÜZELTME SİSTEMLERİ



10"-24"



lathe



b.support / büyük d.



V-belt / kasnaklı



1410x972x1605mm

KÖNIG 54 00 10"-24"

kod.54 00

- Moving lathe
- Big support kit
- Optional bridge support kit
 - V-belt
- Rim rotating speed 250 rpm
 - Net weight 365 kg
 - Kayar tip toma
 - Büyük dayama kiti
- Opsiyonel köprülü dayama kiti
 - Kasnaklı
 - Jant Dönüş hızı 250 rpm
 - Net ağırlık 365 kg



kod. 23 24 000

Optional Bridge Support Kit
Opsiyonel Köprülü dayama kiti



10"-24"



lathe



V-belt / kasnaklı



b.support / büyük d.



1410x1098x1605mm

KÖNIG 57 00 10"-24"

kod.57 00

- Turning lathe
- Big support kit
- Optional bridge support kit
 - V-belt
- Rim rotating speed 250 rpm
 - Net weight 362 kg
 - Döner tip toma
 - Büyük dayama kiti
- Opsiyonel köprülü dayama kiti
 - Kasnaklı
 - Jant Dönüş hızı 250 rpm
 - Net ağırlık 362 kg



kod. 23 24 000

Optional Bridge Support Kit
Opsiyonel Köprülü dayama kiti



10"-24"



V-belt / kasnaklı



b.support / büyük d.



1410x650x1605mm

KÖNIG 57T 00 10"-24"

kod.57T 00

- Big support kit
- Optional bridge support kit
 - V-belt
- Rim rotating speed 250 rpm
 - Net weight 305 kg
 - Büyük dayama kiti
- Opsiyonel köprülü dayama kiti
 - Kasnaklı
 - Jant Dönüş hızı 250 rpm
 - Net ağırlık 305 kg

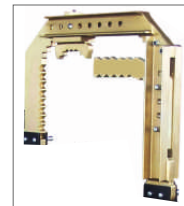

kod. 23 24 000

Optional Bridge Support Kit
Opsiyonel Köprülü dayama kiti



Servis & Garaj Ekipmanları

Single phase or 24V DC motor is optional for all products in this page.

Yukarıdaki tüm ürünlerde monofaze motor seçeneği yada 24V DC motor seçeneği opsiyoneldir.

JUNIOR DOUBLE 10"-24"

kod. 14D 00

- Rim repair with double pistons
- New generation bridge support kit
- Net weight 200 kg
- Non-Lathe
- Non-motorized
- Çift pistonlu jant düzeltme
- Yeni jenerasyon köprülü dayama kit
- Net ağırlık 200 kg
- Tomasız
- Motorsuz

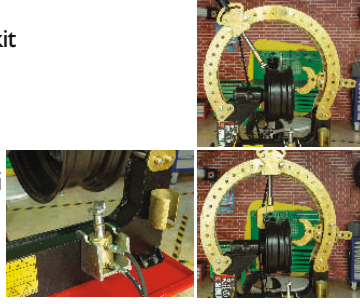

10"-24"



bridge s. / köprülü d.



1233x430x1924mm

NEW
PRODUCT
YENİ
ÜRÜN

PATENTED
BY ATEK

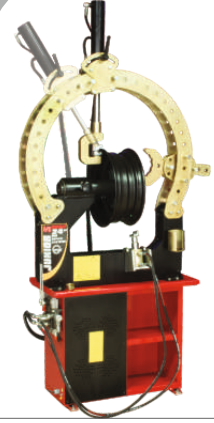

JUNIOR S 10"-24"

kod. 14S 00

- Big support kit
- Net weight 165 kg
- Non-Lathe
- Non-motorized
- Büyük dayama kit
- Net ağırlık 165 kg
- Tomasız
- Motorsuz



10"-24"



b.support / büyük d.



1233x430x1624mm

PATENTED
BY ATEK

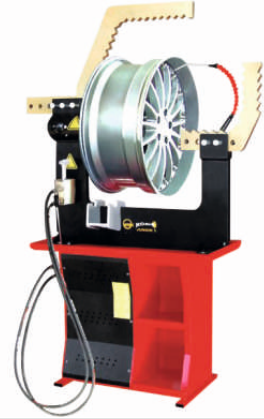

JUNIOR 10"-18"

kod. 14 00

- Small support kit
- Net weight 200 kg
- Non-Lathe
- Non-motorized
- Küçük dayama kit
- Net ağırlık 200 kg
- Tomasız
- Motorsuz



10"-18"



s.support / küçük d.



1210x578x1404mm

PATENTED
BY ATEK

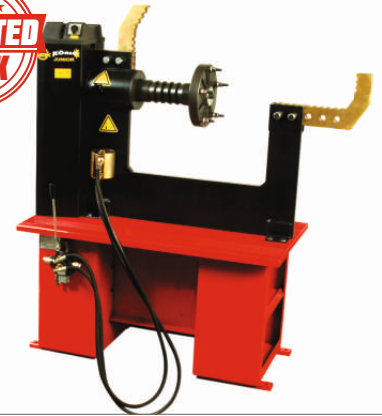

POLISH & CLN KIT

kod. 74 00

- Polish & Cln kit can use only with 55K 00, 54 00, 57 00, 57T 00
- Polish & Cln kit sadece 55K 00, 54 00, 57 00, 57T 00 modellerine uyumludur.



PATENTED
BY ATEK

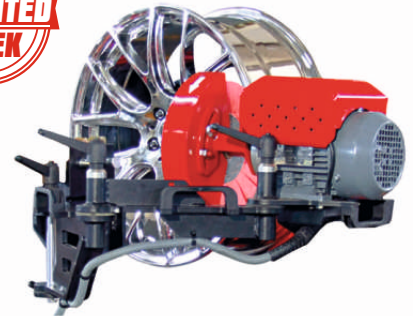

Single phase or 24V DC motor is optional for all products in this page.
Yukarıdaki tüm ürünlerde monofaze motor seçeneği yada 24V DC motor seçeneği opsiyoneldir.



TSEK

NEW
PRODUCT
YENİ
ÜRÜN



INFRARED RIM HEATER

kod.30 00

- Electrical Infrared Rim Heater
- Power : 380v 50-60 hz 6 kw
- Heating time: 2,5 min. \approx 100c°
5 min. \approx 200c°
- Time adjustable up to 4 minutes
- High temperature type silicon cable
 - Adjustable heater height
 - Elektrikli İnfrared Jant Isıtıcı
 - Güç: 380v 50-60 hz 6 kw
 - Isınma süresi: 2,5 dk. \approx 100c°
5 dk. \approx 200c°
 - Zaman ayarlama
- Isiya dayanıklı özel silikon kablolu
 - Ayarlanabilir ısıtıcı yüksekliği



10"-19"



lathe



gear box / redüktör



1378x1130x1480mm

ROLLER MAXI 10"-19"

kod.78D 00

- Rim repair
 - For Aluminium and steel rims
 - Big support kit
 - Gear box
- Rim rotating speed 98 rpm
 - Net weight 368 kg
- Full otomatik jant düzeltme
- Alüminyum ve çelik jantlar için
 - Redüktörü
- Jant Dönüş hız 98 rpm
 - Net ağırlık 368 kg



10"-19"



lathe



gear box / redüktör



1243x1120x1168mm

ROLLER S 10"-19"

kod.78S 00

- Rim repair
 - Only steel rims
 - Big support kit
 - Gear box
- Rim rotating speed 98 rpm
 - Net weight 300 kg
- Full otomatik jant düzeltme
 - Çelik jantlar için
 - Redüktörü
- Jant Dönüş hızı 98 rpm
 - Net ağırlık 300 kg



Servis & Garaj Ekipmanları

Single phase or 24V DC motor is optional for all products in this page.

Yukarıdaki tüm ürünlerde monofaze motor seçeneği yada 24V DC motor seçeneği opsiyoneldir.

BRAVA POLISH S 12"-28"

kod.68BP 00

- For polishing & cleaning
- Rim Diameter (Outside-In) 10" to 20"
- Rim Diameter (Inside-Out) 12"-22"
- Gearbox
- Rim rotating speed 12 rpm
- Easy to reach every point of rim with ergonomic control handle
- Polishing at strong and high stage
- Positioning the rim at requested point
- Emergency stop and foot pedal control
- Separately rim and brush control
- Full otomatik jant temizleme ve parlatma
- Redüktörlü
- Jant Dönüş hızı 12 rpm
- Güçlü ve yüksek aşamada parlatma
- Jantın her istenen noktasında üstün polisaj ve temizleme kolaylığı
- Acil durdurma ve ayak pedali kontrolü
- Çeşitli fırça başlıklarıyla her açıdan kolay ve hızlı işlem sağlar



10"-22"



gear box / redüktör



930x2208x1627mm

NEW
PRODUCT
YENİ
ÜRÜN



POLISH S 11"-30"

kod.68 00

- Polish & cleaning
- Gear box
- Rim rotating speed 12 rpm
- Net weight 240 kg
- Easy to reach every point of rim with ergonomic control handle
- Polishing at strong and high stage
- Positioning the rim at requested point
- Central and conical rim fixing system
- Emergency stop and foot pedal control
- Separately rim and brush control
- Full otomatik jant temizleme ve parlatma
- Redüktörlü
- Jant Dönüş hızı 12 rpm
- Net ağırlık 240 kg
- Güçlü ve yüksek aşamada parlatma
- Jantın her istenen noktasında üstün polisaj ve temizleme kolaylığı
- Merkezi ve konik jant bağlantı sistemi
- Acil durdurma ve ayak pedali kontrolü
- Çeşitli fırça başlıklarıyla her açıdan kolay ve hızlı işlem sağlar



11"-30"



gear box / redüktör



840x1520x1245mm



Single phase or 24V DC motor is optional for all products in this page.
Yukarıdaki tüm ürünlerde monofaze motor seçeneği yada 24V DC motor seçeneği opsiyoneldir.



TSEK

MANAGER | 2"-26"

PROFESSIONAL TYRE CHANGER SYSTEMS / PROFESYONEL LASTİK SÖKME TAKMA SİSTEMLERİ

kod.93 00

- New ergonomic head locking system
- Tool locking with automatic setting of appropriate distance from the rim.
- Yeni ergonomik tetikli kafa kilitleme sistemi
- Janttan uygun uzaklıkta otomatik ayarlı kilitleme.

- Standard Shelf ATEK AIR Inflator
- Standart ATEK Rafılı Hava Saati

- New designed rim flange, perfectly clutching
- Yeni jant bağlama flanşı sayesinde mükemmel şekilde kavrama

- New Push&Leave pedal system
- Yeni Bas&Bırak pedal sistemi



12"-24"



14"-26"



38x115 cm



1.3 / 1,8 Kw



380 Kg



122x181x176 cm

TECHNICAL DATA / TEKNİK DATA

Bead breaker force / Damak düşürme kuvveti	3.5 tons
Rotation speed / Jant dönüş hızı	8-16 rpm (two speed)
Standard Motor (3ph two speed) / Trifaze motor çift devirli	1,3/1,8Kw 380V 50-60 Hz I,5Hp
*Motor (single ph) / Monofaze motor	220V 50-60 Hz I,1Kw I,5 Hp
Working pressure / Çalışma basıncı	8-10 bar
Net weight / Net ağırlık	380 kg

- Extra reinforced profile group that minimizes stretching.
- Esnemeleri minimize eden ekstra güçlendirilmiş profil grubu.

- Automatic tilt back system
- Otomatik kafa geri yatırma sistemi

- Standard PROFESSIONAL PLUS system for high performance tyres
- Yüksek performans lastikleri için standart PROFESYONEL PLUS sistem

- Optional Autolever
- Opsiyonel Otomatik levye

- Mount/demount head specially designed for alloy wheels
- Alaşım jantlar için özel olarak tasarlanmış sökme takma ayağı

- Reinforced automatic bead breaker. Ergonomic jointed and shaped knife.
- Güçlendirilmiş otomatik damak düşürme. Ergonomik mafsallı ve şekilli bıçak.

OPTIONALS / OPSİYONLAR

Optional Autolever

Opsiyonel Otomatik levye

Optional single phase 220V motor

Opsiyonel monofaze 220V motor

Optional TI (Shocking) system for tubless tyres

Tubless lastikler için opsiyonel TI (Şoklama) sistemi

Optional connection parts for motorcycle tyres

Opsiyonel motosiklet bağlantı ayağı



Servis & Garaj Ekipmanları

Single phase or 12V DC motor is optional for all products in this page.

Yukarıdaki tüm ürünlerde monofaze motor seçeneği yada 12V DC motor seçeneği opsiyoneldir.

CALIPSO 10"-24"

PROFESSIONAL TYRE CHANGER SYSTEMS / PROFESYONEL LASTİK SÖKME TAKMA SİSTEMLERİ

kod.91 00

- New ergonomic head locking system
- Tool locking with automatic setting of appropriate distance from the rim.
- Yeni ergonomik tetikli kafa kilitleme sistemi
- Janttan uygun uzaklıkta otomatik ayarlı kilitleme.

- New designed rim flange, perfectly clutching
- Yeni jant bağlama flanşı sayesinde mükemmel şekilde kavrama

- New Push&Leave pedal system
- Yeni Bas&Bırak pedal sistemi

- Extra reinforced profile group that minimizes stretching.
- Esnemeleri minimize eden ekstra güçlendirilmiş profil grubu.

- Automatic tilt back system
- Otomatik kafa geri yatırma sistemi

- Mount/demount head specially designed for alloy wheels
- Alaşım jantlar için özel olarak tasarlanmış sökme takma ayağı

- Reinforced automatic bead breaker. Ergonomic jointed and shaped knife.
- Güçlendirilmiş otomatik damak düşürme. Ergonomik mafsallı ve şekilli bıçak.



10"-22"



12"-24"



32x108 cm



1.1 Kw



250 Kg



122x181x176 cm

TECHNICAL DATA / TEKNİK DATA

Bead breaker force / Damak düşürme kuvveti	3.5 tons
Rotation speed / Jant dönüş hızı	8-16rpm two speed
Standard Motor (3ph two speed) / Trifaze motor çift devirli	1,3/1,8Kw 380V 50-60 Hz 1,5Hp
*Motor (single ph) / Monofaze motor	220V 50-60 Hz 1,1Kw 1,5 Hp
Working pressure / Çalışma basıncı	8-10 bar
Net weight / Net ağırlık	250 kg

OPTIONALS / OPSİYONLAR

Optional PLUS system for high performance tyres
Yüksek performans lastikleri için opsiyonel PLUS sistem

Optional two speed (8-16 rpm)

Opsiyonel çift devirli (8-16 rpm)

Optional single phase 220V motor

Opsiyonel monofaze motor

Optional Shocking system & Shelf ATEK AIR Inflator

Opsiyonel Şoklama sistemi ve ATEK Rafı Hava Saati

Optional Shelf ATEK AIR Inflator

Opsiyonel ATEK Rafı Hava Saati

Optional connection parts for motorcycle tyres

Opsiyonel motosiklet bağlantı ayağı

Single phase or 12V DC motor is optional for all products in this page.
Yukarıdaki tüm ürünlerde monofaze motor seçeneği yada 12V DC motor seçeneği opsiyoneldir.



TSEK

PIERO | 10"-22"

PROFESSIONAL TYRE CHANGER SYSTEMS / PROFESYONEL LASTİK SÖKME TAKMA SİSTEMLERİ

kod.92 00

- New ergonomic head locking system
- Tool locking with automatic setting of appropriate distance from the rim.

- Yeni ergonomik tetikli kafa kilitleme sistemi
- Janttan uygun uzaklıkta otomatik ayarlı kilitleme.

- New designed rim flange, perfectly clutching

- Yeni jant bağlama flanşı sayesinde mükemmel şekilde kavrama

- New Push&Leave pedal system

- Yeni Bas&Bırak pedal sistemi

10"-20"

12"-22"

29x100 cm

1.1 Kw

220 Kg

122x181x176 cm

TECHNICAL DATA / TEKNİK DATA

Bead breaker force / Damak düşürme kuvveti	3.5 tons
Rotation speed / Jant dönüş hızı	8-16rpm two speed
Standard Motor (3ph two speed) / Trifaze motor çift devirli	1,3/1,8Kw 380V 50-60 Hz I,5Hp
*Motor (single ph) / Monofaze motor	220V 50-60 Hz 1,1Kw 1,5 Hp
Working pressure / Çalışma basıncı	8-10 bar
Net weight / Net ağırlık	250 kg

- Extra reinforced profile group that minimizes stretching.
- Esnemeleri minimize eden ekstra güçlendirilmiş profil grubu.

- Automatic tilt back system
- Otomatik kafa geri yatırma sistemi

- Mount/demount head specially designed for alloy wheels
- Alaşım jantlar için özel olarak tasarlanmış sökme takma ayağı

- Reinforced automatic bead breaker. Ergonomic jointed and shaped knife.
- Güçlendirilmiş otomatik damak düşürme. Ergonomik mafsallı ve şekilli bıçak.

OPTIONALS / OPSİYONLAR

Optional PLUS system for high performance tyres
Yüksek performans lastikleri için opsiyonel PLUS sistem

Optional two speed (8-16 rpm)

Opsiyonel çift devirli (8-16 rpm)

Optional single phase 220V motor

Opsiyonel monofaze motor

Optional Shocking system & Shelf ATEK AIR Inflator

Opsiyonel Şoklama sistemi ve ATEK Rafalı Hava Saati

Optional Shelf ATEK AIR Inflator

Opsiyonel ATEK Rafalı Hava Saati

Optional connection parts for motorcycle tyres

Opsiyonel motosiklet bağlantı ayağı



Servis & Garaj Ekipmanları

Single phase or 12V DC motor is optional for all products in this page.
Yukarıdaki tüm ürünlerde monofaze motor seçeneği yada 12V DC motor seçeneği opsiyoneldir.

WINGS | 0"-22"

PROFESSIONAL TYRE CHANGER SYSTEMS / PROFESYONEL LASTİK SÖKME TAKMA SİSTEMLERİ

kod.90 00

- Semi-automatic tyre changer
- Yarı otomatik sökme takma



- New designed rim flange, perfectly clutching
- Yeni jant bağlama flanşı sayesinde mükemmel şekilde kavrama

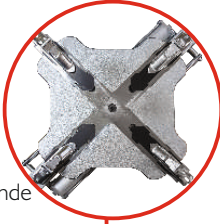

- New Push&Leave pedal system
- Yeni Bas&Bırak pedal sistemi

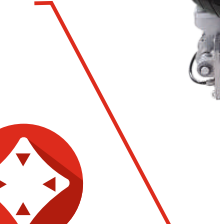

- Mount/demount head specially designed for alloy wheels
- Alaşım jantlar için özel olarak tasarlanmış sökme takma ayağı

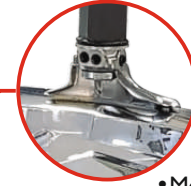

- Reinforced automatic bead breaker. Ergonomic jointed and shaped knife.
- Güçlendirilmiş otomatik damak düşürme. Ergonomik mafsallı ve şekilli bıçak.



10"-20"



12"-22"



29x100 cm



1.1 Kw



220 Kg



122x181x176 cm

TECHNICAL DATA / TEKNİK DATA

Bead breaker force / Damak düşürme kuvveti	3.5 tons
Rotation speed / Jant dönüş hızı	8-16rpm two speed
Standard Motor (3ph two speed) / Trifaze motor çift devirli	1,3/1,8Kw 380V 50-60 Hz 1,5Hp
*Motor (single ph) / Monofaze motor	220V 50-60 Hz 1,1Kw 1,5 Hp
Working pressure / Çalışma basıncı	8-10 bar
Net weight / Net ağırlık	250 kg

OPTIONALS / OPSİYONLAR

Optional PLUS system for high performance tyres
Yüksek performans lastikleri için opsiyonel PLUS sistem

Optional two speed (8-16 rpm)

Opsiyonel çift devirli (8-16 rpm)

Optional single phase 220V motor

Opsiyonel monofaze motor

Optional Shocking system & Shelf ATEK AIR Inflator

Opsiyonel Şoklama sistemi ve ATEK Rafalı Hava Saati

Optional Shelf ATEK AIR Inflator

Opsiyonel ATEK Rafalı Hava Saati

Optional connection parts for motorcycle tyres

Opsiyonel motorsiklet bağlantı ayağı

Single phase or 12V DC motor is optional for all products in this page.
Yukarıdaki tüm ürünlerde monofaze motor seçeneği yada 12V DC motor seçeneği opsiyoneldir.



12"-30"



380x1150mm



1580x1642x2250mm

ROBATEK 12"-30"

kod.59AL 00

- Full automatic tyre changer
- New generation central tyre connecting system
- Integrated Plus system for high performance tyres
- Double joystick control arms
- Standard autolever
- Standard tyre lift
- Standard two speed (8-16 rpm)
- 8-10 bar working pressure
- Net weight 530 kg
- Full otomatik lastik sökme takma
- Yeni nesil göbekten flanş bağlama
- Çift damak düşürme kolu
- Yüksek performans lastikleri için entegre edilmiş Plus sistemi
- Standart otomatik levye
- Standart lastik asansörü
- Standart çift devirli (8-16 rpm)
- 8-10 bar çalışma basıncı
- Net ağırlık 530 kg



12"-24"



14"-26"



380x1150mm



1220x1817x1761mm

CARUZO 12"-26"

kod.80 00

- Full automatic tyre changer
- Optional auto lever
- Standart Plus system for high performance tyres
- Standard two speed (8-16 rpm)
- Standard new generation automatic bead breaker
- Optional TI (Shocking) System
- 8-10 bar working pressure
- Net weight 378 kg
- Full otomatik lastik sökme takma
- Opsiyonel otomatik levye
- Yüksek performans lastikleri için Plus sistemi
- Standart çift devirli (8-16 rpm)
- Standart yeni jenerasyon otomatik damak düşürme kolu
- Opsiyonel şoklama sistemi
- 8-10 bar çalışma basıncı
- Net ağırlık 378 kg

ZANINI 10"-24"

kod.47 00

- Full automatic tyre changer
- Optional Plus system for high performance tyres
- Optional T1 (Shocking) System and Shelf Air Inflator
- Optional two speed (8-16 rpm)
- Optional connection parts for motorcycle tyres
- 8-10 bar working pressure, 8 rpm rotating speed
- Net weight 220 kg
- Full otomatik lastik sökme takma
- Opsiyonel yüksek performanslı lastikler için Plus sistem
- Opsiyonel şoklama sistemi ve raflı hava saati
- Opsiyonel çift devirli (8-16 rpm)
- Opsiyonel motorsiklet bağlantı ayağı
- 8-10 bar çalışma basıncı, 8 rpm dönüş hızı
- Net ağırlık 220 kg



10"-22"



12"-24"



317x1075mm



1135x1620x1885mm



Optional parts used in this image
Bu görselde opsiyonel parçalar kullanılmıştır.

RIVIERA 10"-22"

kod.43 00

- Full automatic tyre changer
- Optional Plus system for high performance tyres
- Optional T1 (Shocking) System and Shelf Air Inflator
- Optional two speed (8-16 rpm)
- Optional connection parts for motorcycle tyres
- 8-10 bar working pressure, 8 rpm rotating speed
- Net weight 204 kg
- Full otomatik lastik sökme takma
- Opsiyonel yüksek performanslı lastikler için Plus sistem
- Opsiyonel şoklama sistemi ve raflı hava saati
- Opsiyonel çift devirli (8-16 rpm)
- Opsiyonel motorsiklet bağlantı ayağı
- 8-10 bar çalışma basıncı, 8 rpm dönüş hızı
- Net ağırlık 204 kg



10"-20"



12"-22"



292x1000mm



1070x1590x1725mm



Optional parts used in this image
Bu görselde opsiyonel parçalar kullanılmıştır.

Single phase or 12V DC motor is optional for all products in this page.
Yukarıdaki tüm ürünlerde monofaze motor seçeneği yada 12V DC motor seçeneği opsiyoneldir.

BRAVA MAXI 12"-26"

kod.70 00

- Semi automatic tyre changer
- Optional Plus system for high performance tyres
- Optional TI (Shocking) System and Shelf Air Inflator
 - Optional two speed (8-16 rpm)
- Optional connection parts for motorcycle tyres
 - 8-10 bar working pressure
 - 8 rpm rotating speed
 - Net weight 216 kg
- Yarı otomatik lastik sökme takma
- Opsiyonel yüksek performanslı lastikler için Plus sistem
 - Opsiyonel şoklama sistemi ve raflı hava saati
 - Opsiyonel çift devirli (8-16 rpm)
- Opsiyonel motosiklet bağlantı ayağı
 - 8-10 bar çalışma basıncı
 - 8 rpm dönüş hızı
 - Net ağırlık 216 kg



12"-24"



14"-26"



380x1100mm



1410x1145x2120mm

**BRAVA JUMBO 12"-24"**

kod.73 00

- Semi automatic tyre changer
- Optional Plus system for high performance tyres
- Optional TI (Shocking) System and Shelf Air Inflator
 - Optional two speed (8-16 rpm)
- Optional connection parts for motorcycle tyres
 - 8-10 bar working pressure
 - 8 rpm rotating speed
 - Net weight 205 kg
- Yarı otomatik lastik sökme takma
- Opsiyonel yüksek performanslı lastikler için Plus sistem
 - Opsiyonel şoklama sistemi ve raflı hava saati
 - Opsiyonel çift devirli (8-16 rpm)
- Opsiyonel motosiklet bağlantı ayağı
 - 8-10 bar çalışma basıncı
 - 8 rpm dönüş hızı
 - Net ağırlık 205 kg



12"-22"



14"-24"



317x1024mm



1410x1145x2120mm



PIKOLA 10"-22"

kod.41 00

- Semi automatic tyre changer
- Optional Plus system for high performance tyres
- Optional TI (Shocking) System and Shelf Air Inflator
- Optional two speed (8-16 rpm)
- Optional connection parts for motorcycle tyres
- 8-10 bar working pressure
- 8 rpm rotating speed
- Net weight 216 kg
- Yarı otomatik lastik sökme takma
- Opsiyonel yüksek performanslı lastikler için Plus sistem
- Opsiyonel şoklama sistemi ve raflı hava saati
- Opsiyonel çift devirli (8-16 rpm)
- Opsiyonel motorsiklet bağlantı ayağı
- 8-10 bar çalışma basıncı
- 8 rpm dönüş hızı
- Net ağırlık 216 kg



10"-20"



12"-22"



292x1000mm



1070x1020x1600mm



Optional parts used in this image
Bu görselde opsiyonel parçalar kullanılmıştır.

BRAVA 10"-22"

kod.04 00

- Semi automatic tyre changer
- Optional Plus system for high performance tyres
- Optional TI (Shocking) System and Shelf Air Inflator
- Optional two speed (8-16 rpm)
- Optional connection parts for motorcycle tyres
- 8-10 bar working pressure
- 8 rpm rotating speed
- Net weight 185 kg
- Yarı otomatik lastik sökme takma
- Opsiyonel yüksek performanslı lastikler için Plus sistem
- Opsiyonel şoklama sistemi ve raflı hava saati
- Opsiyonel çift devirli (8-16 rpm)
- Opsiyonel motorsiklet bağlantı aparatı
- 8-10 bar çalışma basıncı
- 8 rpm dönüş hızı
- Net ağırlık 185 kg



10"-20"



12"-22"



292x1000mm



1070x1020x1600mm



Optional parts used in this image
Bu görselde opsiyonel parçalar kullanılmıştır.

Single phase or 12V DC motor is optional for all products in this page.
Yukarıdaki tüm ürünlerde monofaze motor seçeneği yada 12V DC motor seçeneği opsiyoneldir.



TSEK

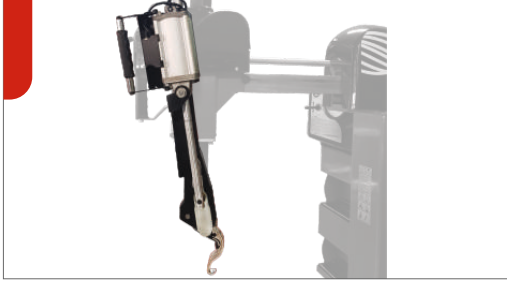

AUTO LEVER 10"-24"

kod. 48 00

- Optional Auto Lever for Manager full automatic tyre changers
 - 8-10 bar working pressure
- Opsiyonel Otomatik Levye Manager full otomatik sökme takma makinası için
 - 8-10 bar çalışma basıncı



PROFESSIONAL PLUS SYSTEMS 10"-24"

kod. 48 00

- Optional Plus system for full automatic tyre changers
 - 8-10 bar working pressure
- Full otomatik lastik sökme takma makineleri için opsiyonel Plus sistemi
 - 8-10 bar çalışma basıncı



PROFESSIONAL PLUS SYSTEMS 10"-22"

kod. 485 00

- Optional Plus system for semi automatic tyre changers
 - 8-10 bar working pressure
- Yarı otomatik lastik sökme takma makineleri için opsiyonel Plus sistemi
 - 8-10 bar çalışma basıncı

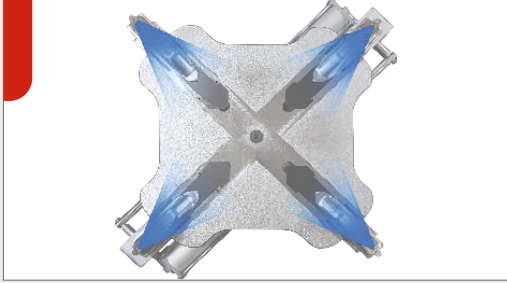

PROFESSIONAL TI SYSTEMS

kod.

- Optional Tubeless Shocking system for tyre changers
 - 8-10 bar working pressure
- Lastik sökme takma makineleri için opsiyonel Şoklama sistemi
 - 8-10 bar çalışma basıncı



PROFESSIONAL AIR INFLATOR SHELF

kod.80 12

- Optional Atek Air inflator system with shelves
- Lastik sökme takma makineleri için opsiyonel ATEK hava saatli raf sistemi
- Opsiyonel Şoklama sistemi tercihinde ATEK hava saatli raf sistemi birlikte gelir.

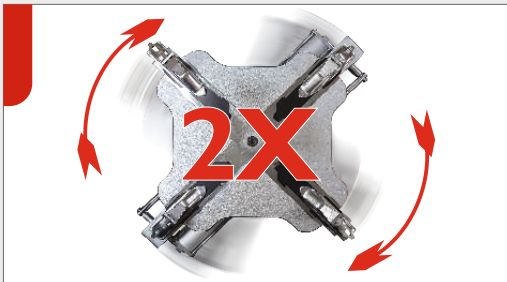

PROFESSIONAL TWO SPEED

kod.

- Optional Two speed for tyre changers
- Lastik sökme takma makineleri için opsiyonel çift devir

PLUS SYSTEMS 10"-24"

kod. 48 00

- Optional Plus system for full automatic tyre changers
- 8-10 bar working pressure
- Full otomatik lastik sökme takma makineleri için opsiyonel Plus sistemi
- 8-10 bar çalışma basıncı

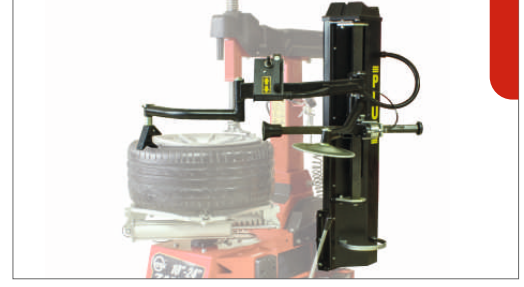

PLUS SYSTEMS 10"-22"

kod. 48S 00

- Optional Plus system for semi automatic tyre changers
- 8-10 bar working pressure
- Yarı otomatik lastik sökme takma makineleri için opsiyonel Plus sistemi
- 8-10 bar çalışma basıncı



TI SYSTEMS

kod.

- Optional Tubeless Shocking system for tyre changers
- 8-10 bar working pressure
- Lastik sökme takma makineleri için opsiyonel Şoklama sistemi
- 8-10 bar çalışma basıncı



ATEK RACK SYSTEMS

kod.80 12

- Optional ATEK rack systems for tyre changers
- Lastik sökme takma makineleri için opsiyonel ATEK hava saatli raf sistemi
- Opsiyonel Şoklama sistemi tercihinde ATEK hava saatli raf sistemi birlikte gelir.



TWO SPEED

kod.

- Optional Two speed for tyre changers
- Lastik sökme takma makineleri için opsiyonel çift devir

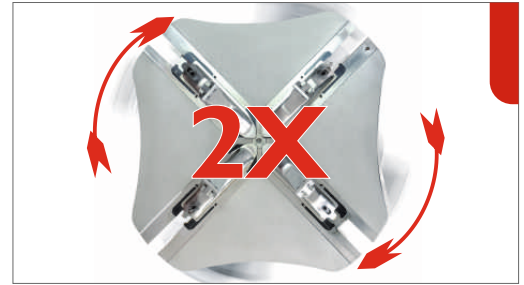

TYRE CLAMPS FOR MOTORCYCLE

kod. 63 00

- Optional tyre clamps for motorcycle tyres (4pcs)
- Motorsiklet jant bağlantı kolları (4 adet)

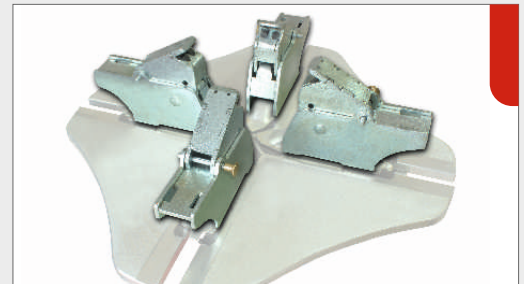

Single phase or 12V DC motor is optional for all products in this page.
Yukarıdaki tüm ürünlerde monofaze motor seçeneği yada 12V DC motor seçeneği opsiyoneldir.



Optional parts used in this image
Bu görselde opsiyonel parçalar kullanılmıştır.



14"-56"



1065x2300mm



1200kg



2257x1720x1540mm



Standard 24V DC

SPEEDY 14"-56"

kod.33 00

- Full automatic heavy duty tyre changer
 - Standard two speed (6-12 rpm)
 - Standard rim fixing clamp and lever
 - Standard remote control
 - Optional moving panel
 - Optional rim clamps 46"-56"
 - Optional tractor lever
 - Net weight 860 kg
- Full otomatik kamyon ve iş mak. lastik sökme takma
 - Standart çift devirli (6-12 rpm)
 - Standart topuk itme pensesi ve levye
 - Standart uzaktan kumanda
 - Opsiyonel kollu kumanda
 - Opsiyonel ilave ayaklar 46"-56"
 - Opsiyonel roller çampara
 - Opsiyonel traktör levyesi
 - Net ağırlık 860 kg



Optional parts used in this image
Bu görselde opsiyonel parçalar kullanılmıştır.



14"-30"



700x1600mm



1000kg



1994x1375x1084mm



Standard 24V DC

SWING 14"-30"

kod.83 00

- Full automatic truck tyre changer
 - Optional two speed (6-12 rpm)
- Standard rim fixing clamp, Standard lever
 - Standard remote control
 - Optional moving panel
 - Optional roller
 - Net weight 542 kg
- Full otomatik ağır vasıta lastik sökme takma
 - Opsiyonel çift devirli (6-12 rpm)
 - Standart topuk itme pensesi
 - Standart levye
 - Standart uzaktan kumanda
 - Opsiyonel kollu kumanda
 - Opsiyonel roller çampara
 - Net ağırlık 542 kg



Optional parts used in this image
Bu görselde opsiyonel parçalar kullanılmıştır.



14"-30"



700x1600mm



1000kg



1994x1375x1084mm



Standard 24V DC

SWING ECO 14"-30"

kod.83 00-EKO

- Full automatic truck tyre changer
 - Optional two speed (6-12 rpm)
- Standard rim fixing clamp, Standard lever
 - Standard remote control
 - Optional moving panel
 - Optional roller
 - Net weight 505 kg
- Full otomatik ağır vasıta lastik sökme takma
 - Opsiyonel çift devirli (6-12 rpm)
 - Standart topuk itme pensesi
 - Standart levye
 - Standart uzaktan kumanda
 - Opsiyonel kollu kumanda
 - Opsiyonel roller çampara
 - Net ağırlık 505 kg

ALLEGRO 14"-28"

kod.53Y 00

- Full automatic truck tyre changer
- Standard rim fixing clamp
- Standard lever
- Standard remote control
- Optional moving panel
- Optional roller
- Net weight 540 kg
- Full otomatik ağır vasıta lastik sökme takma
- Standart topuk itme pensesi
- Standart levye
- Standart uzaktan kumanda
- Opsiyonel kollu kumanda
- Opsiyonel roller çampara
- Net ağırlık 540 kg



14"-28"



700x1600mm



1000kg



2045x1424x1139mm



Standard 24V DC



Optional parts used in this image
Bu görselde opsiyonel parçalar kullanılmıştır.

ALLEGRO ECO 14"-28"

kod.66Y 00

- Full automatic truck tyre changer
- Standard rim fixing clamp
- Standard lever
- Standard remote control
- Optional moving panel
- Optional roller
- Net weight 510 kg
- Full otomatik ağır vasıta lastik sökme takma
- Standart topuk itme pensesi
- Standart levye
- Standart uzaktan kumanda
- Opsiyonel kollu kumanda
- Opsiyonel roller çampara
- Net ağırlık 510 kg



14"-28"



700x1600mm



1000kg



2045x1424x1139mm



Standard 24V DC



Optional parts used in this image
Bu görselde opsiyonel parçalar kullanılmıştır.

MOBİL ALLEGRO 14"-26"

kod.65 00

- Full automatic truck mobile tyre changer
- Optional two speed (6-12 rpm)
- Standard rim fixing clamp • Standard lever
- Standard remote control • Optional moving panel
- Standard roller • Net weight 700 kg
- Mobil araçlar için full otomatik ağır vasıta lastik sökme takma
- Opsiyonel çift devirli (6-12 rpm)
- Standart topuk itme pensesi • Standart levye
- Standart uzaktan kumanda • Opsiyonel kollu kumanda
- Standart roller çampara • Net ağırlık 700 kg



14"-26"



600x1300mm



700kg



1055x1020x1453mm



Standard 24V DC



Optional parts used in this image
Bu görselde opsiyonel parçalar kullanılmıştır.



3200kg



2000mm



105mm



1810x1934x105mm

PRIMA LIFT 3.2T

kod. 38 00

- Scissor lift 3,2 tons
 - Electrohydraulic
 - Safety lock
- Net weight 725 kg
 - Makaslı lift 3,2 ton
 - Elektrohidrolik
 - Güvenlik kilitti
 - Net ağırlık 725 kg



3000kg



1000mm



105mm



1810x1934x105mm

RECEPTION LIFT 3T

kod.16R 00 / 16RK 00 / 16RK 00 KD

- Reception lift 3 tons
 - Electrohydraulic
 - Safety lock
- Mechanical Lock (16RK 00 / 16 RK 00 KD)
 - Without Mechanical Lock (16R 00)
- Galvanized coated for outdoor (16 RK 00 KD)
 - Net weight 450 kg
 - Resepsiyon lift 3 ton
 - Elektrohidrolik
 - Güvenlik kilitti
 - Mekanik kilitti (16RK 00 / 16RK 00 KD)
 - Mekanik kilitsiz (16R 00)
 - Dış mekan için Galvaniz kaplama(16 RK 00 KD)
 - Net ağırlık 450 kg

Mechanical Lock / Mekanik kilit

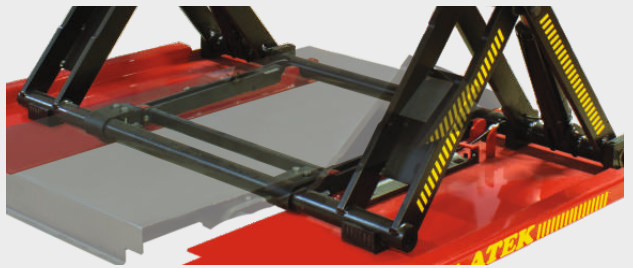

PLATFORM LIFT 3T

kod.16 00 / 16 00K / 16 00K4

- Pneumatic platform lifts
- Max lifting capacity 3000 kg
- 16 00 non arm
- 16 00K 2 arms
- 16 00K4 4 arms
- Working Pressure 8-10 bar
- Net weight 425-435-445 kg
- Pnömatik platform lift
- Maksimum kaldırma kapasitesi 3000 kg
- 16 00 kolsuz
- 16 00K 2 kollu
- 16 00K4 4 kollu
- Çalışma basıncı 8-10 bar
- Net ağırlık 425-435-445 kg



3000kg



493mm



165mm



2000x3630x165mm

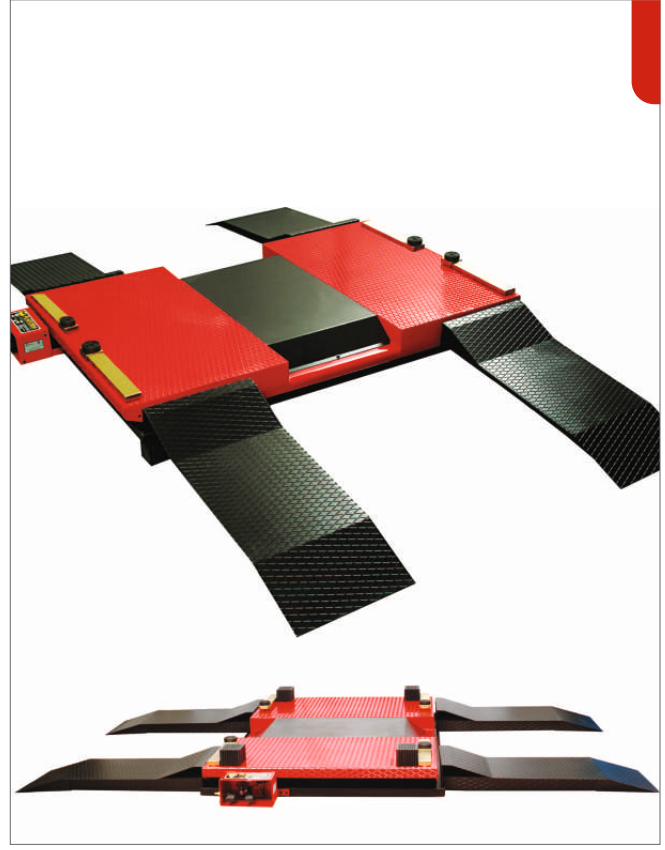

MOTO LIFT 750KG

kod.42 00

- Motorcycle lift 750 kg
- Electrohydraulic
- Mechanic lock
- Minimum platform height 140mm
- Maximum lifting height 1000mm
- Minimum uzunluk 2100mm
- Maximum uzunluk 2631mm
- Platform width 903mm
- Working pressure 190 bar
- Motosiklet lifti 750 kg
- Elektrohidrolik
- Mekanik kilitle
- Minimum platform yüksekliği 140mm
- Maksimum kaldırma yüksekliği 1000mm
- Minimum uzunluk 2100mm
- Maksimum uzunluk 2631mm
- Platform genişliği 903mm
- Çalışma basıncı 190 bar



750kg



1000mm



140mm



2100x2631x903mm

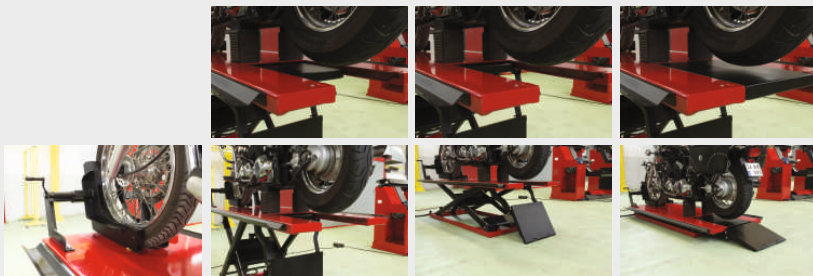



Optional parts used in this image
Bu görselde opsiyonel parçalar kullanılmıştır.

NITROTOWER+300 lt TANK

kod.81 00

- Nitrogen producing capacity 3000 lt/h
 - Nitrogen and air output
 - Monometer, air treatment
 - Nitrogen purity %98
 - Working pressure 8-10 bar
 - Optional tank (100,200,500 lt)
- Nitrojen üretim kapasitesi 3000 lt/h
 - Nitrojen ve hava çıkışları
 - Monometre • şartlandırıcı • Nitrojen saflığı %98
 - Çalışma basıncı 8-10 bar
 - Opsiyonel tank (100,200,500 lt)



AIRTOWER

kod.81 00-AT

- Double air real with 20m hose
 - Monometer
 - Air treatment
- Çift hava reali 20m hortumlu
 - Yağlı ve kuru hava
 - Monometre
 - Şartlandırıcı



MULTI 1"

kod.05 00

- Electrical impact wrench
 - Socket size 1"
 - Max torque 950 Nm
- Rotating speed 1400 rpm
 - Net weight 64 kg
 - Elektrikli bijon sökme
 - Soket ölçüsü 1"
- Dönme hızı 1400 rpm
 - Net ağırlık 64 kg

TYRE FIX

kod.37 00 CE

- Lastik janta takıldıktan sonra (özellikle low profil lastiklerde) lastiğin yakanları janta her zaman düzgün bir şekilde oturmayabilir.
- Lastiğe bu şekilde balans ve/veya rot ayarı yapılırsa, araç yola çıktıktan kısa süre sonra balans ve rot ayarları bozulacak ve araç kullanıcısında memnuniyetsizlik oluşacaktır.
- Tyre Fix-Road Simulator; lastik takma işlemini yaptıktan sonra, lastiğe masaj yaparak asfalt ve stabilize yol simülasyonu uygular.
- Lastiği araç üzerinde ve kullanım esnasında karşılaşılabilecek darbelerle maruz bırakarak, jant yanaklarına düzgün bir şekilde oturmasına olanak sağlar.
- Bu simülasyondan sonra balans ve rot ayarı doğru bir şekilde yapılabilmektedir.

NEW
PRODUCT
YENİ
ÜRÜN



PAINTER

kod.50 00

- Rim Painting Cabinet
- Exproof Fan With Explosion Protection
- Exproof interior lighting
- 0.37 Kw 1.1 Amp. 2.950 D / D 380v 50-60hz
- Air Flow 2000 m3/h
- Pressure Loss 300 Pa
- Yield 80%
- Operating Temperature -40 / +50 C
- Jant Boyama Kabini
- Patlamaya Karşı Korumalı Fan
- Patlamaya karşı iç aydınlatma
- 0,37 Kw 1,1 Amp. 2.950 D / D 380v 50-60Hz
- Hava Akışı 2000 m3/h
- Basınç Kaybı 300 Pa
- Verim% 80
- Çalışma Sıcaklığı -40 / +50 C

NEW
PRODUCT
YENİ
ÜRÜN





15-30-50 ton



350x853x1409mm

HPJ50T3 15-30-50T

kod.20 50T 00

- Hydropneumatic jacks
- Lifting capacity 15-30-50 tons
- Max lifting height 327mm (with socket 497mm)
 - Min height 156mm
- Working pressure 8 bar
 - Net weight 60 kg
- Hidropnömatik krikolar
- Yük kaldırma kapasitesi 15-30-50 ton
- Maks kaldırma yüksekliği 327mm (497mm soketli)
 - Min yükseklik 156mm
- Çalışma basıncı 8 bar
 - Net ağırlık 60 kg



3 ton



395x1218x335mm



395x313x335mm

BANDONI B01/B02 3T

kod.10B3 00 / 10B2 00

- Pneumatic jacks
- Lifting capacity 3 tons
- Max lifting height 240mm
 - Min height 155mm
- Working pressure 8 bar
 - Net weight 22-15 kg
- Phömatik krikolar
- Özel rot kanalı için (10B2 00)
- Yük kaldırma kapasitesi 3 ton
- Maks kaldırma yüksekliği 240mm
 - Min yükseklik 155mm
- Çalışma basıncı 8 bar
 - Net ağırlık 22-15 kg



BOTTLE JACK ŞİŞE KRİKOLAR

	Body height Gövde Yük.	Lifting h. Kaldırma Yük.	Weight Ağırlık	Screw height Vida Yük.	Bottom sur. Taban alanı
3 ton	190mm	130mm	3,1kg	100mm	98,8
5 ton	215mm	140mm	6kg	90mm	153
15 ton	248mm	160mm	11,7kg	105mm	204
25 ton	252mm	160mm	17kg	110mm	321
30 ton	252mm	160mm	17kg	110mm	321
50 ton	290mm	165mm	40kg	-mm	480
10 ton(double)	175mm	215mm	8,7kg	600mm	123

VULCANIZATION INNER TYRE İÇ LASTİK KAYNAK MAKİNASI

kod.08 00

- Height 1355-1435mm
- Depth 355mm, Width 225mm
- Standard pattern of valve
- Yükseklik 1355-1435mm
- Derinlik 355mm, Genişlik 225mm
- Standart sibop kalıbı



VULCANIZATION OUTER TYRE DIŞ LASTİK KAYNAK MAKİNASI

kod.09 00

- Height 1640-1920mm
- Depth 500-730mm •Width 300mm
- Standard pattern of 3pcs iron
- Yükseklik 1640-1920mm
- Derinlik 500-730mm •Genişlik 300mm
- Standart 3 farklı pişirme kalıbı



TRAKDAM

kod.82 00

- Tractor and JCB bead breaker
- Bead breaker force 2500kg
- Stork 65mm
- Working pressure 8-10 bar
- Traktör ve JCB lastikleri damak düşürücü
- Damak düşürme kuvveti 2500kg
- Stork 65 mm
- Çalışma basıncı 8-10 bar



SPEEDAIR

kod.07 00

- Tubeless shocking for air tank
- Tank capacity 22 lt
- Working Pressure 8 bar
- Şoklama tüpü
- 22 lt tank kapasitesi
- Çalışma basıncı 8 bar



TUBELESS LEVER KIT

kod.32 00

- For heavy duty tyre
- Tubeless tyre lever kit
- Ağır vasıtalar için
- Tubeless levye seti





STV2



- For small vans up to 7.5 t / SLW (lightweight) up to 5 t
 - 500 kg lifting capacity with 600 mm load distance
- Material of platform Alu., • Platform type Flat, • Voltage 12/24V
 - Robust four-cylinder lifting mechanism
- Simple attachment thanks to bolttable mounting plates
 - Also available as part-sized tail lift
- Available for: Mercedes-Benz Sprinter 3/5, Volkswagen Crafter 30/35/50, Iveco Daily, Renault Master, Ford Transit, Citroen Jumper, Fiat Ducato, Peugeot Boxer
 - 5 tona kadar 7.5 t / SLW (hafif) küçük vanlar için
 - 600 mm yük mesafesinde 500 kg kaldırma kapasitesi
 - Kapak Tipi Alu., • Platform Tipi Düz, • Voltaj 12/24V
 - Sağlam dört silindirli kaldırma mekanizması
 - Cıvatalı montaj plakaları sayesinde basit montaj
- Aynı zamanda parça büyüklüğündeki kuyruk kaldıncı olarak da mevcuttur
- Uygulanabilir Araçlar: Mercedes-Benz Sprinter 3/5, Volkswagen Crafter 30/35/50, Iveco Daily, Renault Master, Ford Transit, Citroen Jumper, Fiat Ducato, Peugeot Boxer

STD 750



- 750 kg lifting capacity with 600 mm load distance
 - Material of platform Alu.
 - Platform type Flat/foldable
 - Voltage 12/24V
 - Robust four-cylinder lifting mechanism
- Simple attachment thanks to bolttable mounting plates
 - Also available as part-sized tail lift
- Available for: Iveco Daily, Citroen Jumper, Fiat Ducato, Peugeot Boxer (*Open Body Vans)
 - 600 mm yük mesafesinde 750 kg kaldırma kapasitesi
 - Kapak Tipi Alu.
 - Platform Tipi Düz / Katlanır
 - Voltaj 12/24V
 - Sağlam dört silindirli kaldırma mekanizması
 - Cıvatalı montaj plakaları sayesinde basit montaj
 - Aynı zamanda parça büyüklüğündeki kuyruk kaldıncı olarak da mevcuttur
- Uygulanabilir Araçlar: Iveco Daily, Citroen Jumper, Fiat Ducato, Peugeot Boxer (*Open Açık Kasa Van)

ST 750



- For small vans up to 7.5 t / SLW (lightweight) up to 5 t
 - 750 kg lifting capacity with 600 mm load distance
- Material of platform Alu., • Platform type Flat/foldable, • Voltage 12/24V
 - Robust four-cylinder lifting mechanism
- Simple attachment thanks to bolttable mounting plates
 - Also available as part-sized tail lift
- Available for: Mercedes-Benz Sprinter 3/5, Volkswagen Crafter 30/35/50, Iveco Daily, Renault Master, Ford Transit, Citroen Jumper, Fiat Ducato, Peugeot Boxer
 - 5 tona kadar 7.5 t / SLW (hafif) küçük vanlar için
 - 600 mm yük mesafesinde 750 kg kaldırma kapasitesi
 - Kapak Tipi Alu., • Platform Tipi Düz / Katlanır, • Voltaj 12/24V
 - Sağlam dört silindirli kaldırma mekanizması
 - Cıvatalı montaj plakaları sayesinde basit montaj
 - Aynı zamanda parça büyüklüğündeki kuyruk kaldıncı olarak da mevcuttur
- Uygulanabilir Araçlar: Mercedes-Benz Sprinter 3/5, Volkswagen Crafter 30/35/50, Iveco Daily, Renault Master, Ford Transit, Citroen Jumper, Fiat Ducato, Peugeot Boxer





MARUNI MR(GNR)

- Radial tire patches
- Dış lastik radyal yamaları



	Size(mm) Ebat	Pcs box Kutudaki adet											
MR-08	48x68	20	•										
MR-10	56x77	20	•										
MR-12	70x120	10	•	•									
MR-14	82x130	10	•										
MR-18	75x100	10		•	•								
MR-20	85x135	10		•	•	•	•	•	•	•			
MR-22	80x180	10		•					•	•			
MR-25	119x133	10				•	•						
MR-35	130x180	10				•	•						
MR-40	115x200	10			•	•	•	•					
MR-42	130x270	10				•	•	•	•				
MR-44	130x335	10				•	•					•	
MR-45	180x230	10				•	•					•	
MU (GUT)(ÇİVİ DELİKLERİ İÇİN)													
MU-A0	34	100	•										
MU-00	43	100	•										
MU-01	65	50	•										
MU-02	78	50	•										
MU-BO	52	50											



MARUNI MB/MS(GBT/GBS)

- Diagonal tire patches
- Bezli lastik yamaları



	Size(mm) Ebat	Pcs box Kutudaki adet											
MB-01	60	30	•										
MB-02	80	15	•										
MB-03	98	10	•	•	•	•	•						
MB-04	127	10	•	•	•	•	•						
MB-05	165	10	•	•	•	•	•						
MB-06	240	10	•	•	•	•	•						
MB-07	295	10	•	•	•	•	•						
MB-08	345	10	•	•	•	•	•						
MB-09	390	10	•	•	•	•	•						
MB-10	450	5	•	•	•	•	•						
MB-20	255	10										•	
MB-21	370	5										•	•
MB-23	255	10										•	•
MB-25	510	3										•	•
MS-06	240	10		•	•	•	•					•	
MS-07	295	10		•	•	•	•					•	
MS-08	345	10		•	•	•	•					•	

MARUNI PW

- Plug patches
- Mantar yamaları

	Size(mm)	Pcs box
	Ebat	Kutudaki adet
PW 3505	60	20
PW 4007	80	40
PW 5609	98	20
PW 8012	127	6

Maruni
LASTİK TAMİR MALZEMELERİ



MARUNI POWER VALKASEAL

- Valkaseal
- Fıtil yamalar

	Size(mm)	Pcs box
	Ebat	Kutudaki adet
L 1430	140	30
L 2030	200	30

Maruni
LASTİK TAMİR MALZEMELERİ



MARUNI ROUND / YUVARLAK

- Round inner tube patches
- Yuvarlak iç lastik tamir yamaları

	Size(mm)	Pcs layer
	Ebat	Tabaka adeti
MODEL R	25	1 tab. 64 ad
MODEL S2	30	1 tab. 36 ad
MODEL M2	40	1 tab. 25 ad
MODEL L3	52	1 tab. 16 ad
MODEL Q03	61	1 tab. 9 ad
MODEL R03	76	1 tab. 9 ad
MODEL R04	108	1 tab. 4 ad

Maruni
LASTİK TAMİR MALZEMELERİ

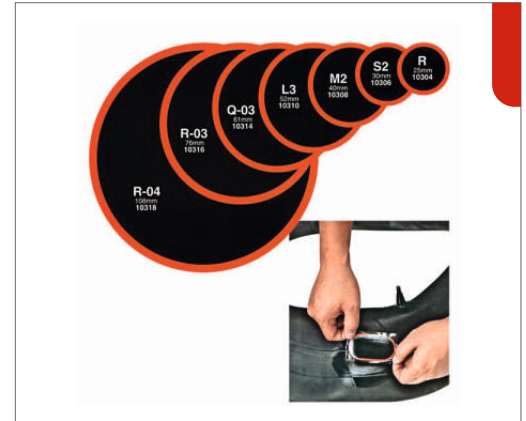

MARUNI OVAL / OVAL

- Oval inner tube patches
- Oval iç lastik tamir yamaları

	Size(mm)	Pcs layer
	Ebat	Tabaka adeti
MODEL S	24x34	1 tab. 48 ad
MODEL M	28x42	1 tab. 35 ad
MODEL M3	24x57	1 tab. 32 ad
MODEL L	33x53	1 tab. 24 ad
MODEL L2	41x76	1 tab. 15 ad
MODEL OV01	41x107	-
MODEL OV02	66x138	1 tab. 6 ad
MODEL OV03	91x159	1 tab. 6 ad

Maruni
LASTİK TAMİR MALZEMELERİ





Maruni
LASTİK TAMİR MALZEMELERİ



MARUNI SUPER VALKARN G

kod.20 03 38186 Super Valkarn G 100cc (140gr)
kod.20 03 38188 Super Valkarn G 200cc (280gr)
kod.20 03 38190 Super Valkarn G 1000cc (1400gr)

- Outer tube solutions
- İç lastik yama solüsyonları



Maruni
LASTİK TAMİR MALZEMELERİ



MARUNI VALKARN

kod.20 03 35186 Valkarn 100cc (140gr)
kod.20 03 35188 Valkarn 200cc (280gr)
kod.20 03 35190 Valkarn 1000cc (1400gr)

- Inner tube solutions
- İç lastik yama solüsyonları



Maruni
LASTİK TAMİR MALZEMELERİ



MARUNI THERMO LIQUID

kod.20 03 39190 Thermo liquid 1000cc (1300gr)

- Inner tube thermo solution
- İç lastik sıcak yama solüsyonu



Maruni
LASTİK TAMİR MALZEMELERİ



MARUNI BEAD SEALER

• Sealing between the rim
• Lastik jant arası sızdırmazlık solüsyonu
kod.20 03 60123 Bead Sealer 1000cc (1300gr)



Maruni
LASTİK TAMİR MALZEMELERİ



MARUNI SEALINER

kod.20 03 60123 Sealiner 1000cc (1300gr)

- Tyre patch for long life
- Lastik yaması koruyucu solüsyonu



Maruni
LASTİK TAMİR MALZEMELERİ



MARUNI LIQUID BUFFER

- kod.-** Liquid Buffer
- Chemical cleaner for the inside of tires, tubes and conveyor belts.
 - Can be used in place of machine buffing for small injuries.
 - Non-Flammable.
 - Yama uygulama öncesi havali taşlama ile yapılan temizleme işlemine son veren
 - Liquid Buffer ile hızlı ve kolay ön hazırlık sağlayan sıvı temizleyici
 - Yanıcı değildir.

UNITROL MONOLITH

kod.10 02 MONOLITH

- 20" LCD ekran, •Jant ölçüsü: 10"-30"
- Jant genişliği: maks. 15", •Lastik ölçüsü: 36"
- Lastik dönüş hızı: 175 rpm, •Maks. lastik ağırlığı: 80 kg.
- Kolay, hızlı Türkçe menü ve seslendirme
- SPLIT (kurşun bölme özelliği), •Otomatik Mesafe Ölçümü
- Hava Girişi: 6-10 bar, •Lazer ile kurşun yerini gösterme
- Havalı lastik kilitleme

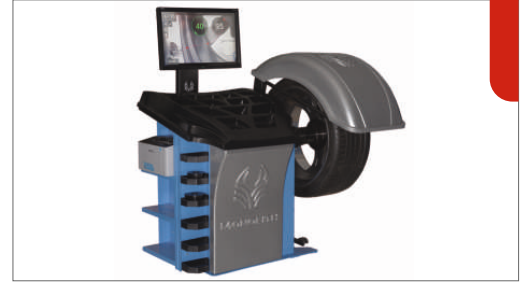

UNITROL 235I / 235I PL

kod.10 02 235I LCD / 10 02 235I PL LCD

- 20" LCD ekran, •Jant ölçüsü: 10"-30"
- Jant genişliği: maks. 15", •Lastik ölçüsü: 36"
- Lastik dönüş hızı: 175 rpm, •Maks. lastik ağırlığı: 70 kg.
- Kolay, hızlı Türkçe menü ve seslendirme
- SPLIT (kurşun bölme özelliği), •Otomatik Mesafe Ölçümü
- Hava Girişi: 6-10 bar, Lazer ile kurşun yerini gösterme (235I PL)
- Havalı lastik kilitleme (235I PL)



UNITROL 2162

kod.10 02 2162

- 20" LCD ekran
- Jant ölçüsü: 10"-26"
- Jant genişliği: maks. 20"
- Lastik dönüş hızı: 120 rpm
- Maks. lastik ağırlığı: 200 kg.
- Kolay, hızlı Türkçe menü ve seslendirme, •Bütün kurşun tiplerini tanıyabilme
- Binek ve Kamyon Lastiklerine Uyumlu
- Standart lastik asansörü



UNITROL 2312

kod.10 02 2312

- Dijital ekran
- Jant ölçüsü: 10"-30"
- Jant genişliği: maks. 15", •Lastik ölçüsü: 36"
- Lastik dönüş hızı: 175 rpm, •Maks. lastik ağırlığı: 70 kg.
- Kolay, hızlı Türkçe menü ve seslendirme, •SPLIT (kurşun bölme özelliği)
- Otomatik Mesafe Ölçümü
- Hava Girişi: 6-10 bar



UNITROL MICRO

kod.10 02 MICRO

- Dijital ekranlı
- Jant ölçüsü: -
- Jant genişliği: maks. 3"-12"
- Lastik ölçüsü: 740mm
- Lastik dönüş hızı: - rpm
- Maks. lastik ağırlığı: 60 kg.
- Kolay, hızlı menü ve grafikler, •Bütün kurşun tiplerini tanıyabilme özelliği



UNITROL MICRO M MOTORCYCLE

kod.10 02 MICRO M

- Dijital ekranlı
- Jant ölçüsü: -
- Jant genişliği: maks. 3"-12"
- Lastik ölçüsü: 740mm
- Lastik dönüş hızı: - rpm
- Maks. lastik ağırlığı: 60 kg.
- Kolay, hızlı menü ve grafikler, •Bütün kurşun tiplerini tanıyabilme özelliği





FASEP V590

kod.10 04 V590

- Kamyon ve otobüs lastikleri için
 - LCD ekran
 - Jant ölçüsü: 8"-26"
 - Jant genişliği: maks. 8,5"-28"
 - Lastik ölçüsü: 50"
 - Maks. lastik ağırlığı: 200 kg.
 - Kolay, hızlı menü ve grafikler
 - Lastik asansörlü



FASEP B350

kod.10 04 B350

- Kamyon ve otobüs lastikleri için
 - Dijital ekran
 - Jant ölçüsü: 8"-26"
 - Jant genişliği: maks. 8,5"-28"
 - Lastik ölçüsü: 50"
 - Maks. lastik ağırlığı: 200 kg.
 - Kolay, hızlı menü ve grafikler
 - Lastik asansörlü



FASEP B212 NANO

kod.10 04 B212 NANO

- Gezici servisler için 12V motor seç.
 - Jant ölçüsü: 8"-26"
 - Jant genişliği: maks. 16"
 - Lastik ölçüsü: 49"
 - Lastik dönüş hızı: 98 rpm
 - Maks. lastik ağırlığı: 75 kg.
 - Kolay, hızlı menü ve grafikler
- Bütün kurşun tiplerini tanıyabilme özelliği



FASEP B202 MOTORCYCLE

kod.10 04 B202

- Dijital ekranlı
 - Jant ölçüsü: 8"-26"
 - Jant genişliği: maks. 16"
 - Lastik ölçüsü: 49"
- Lastik dönüş hızı: 75-125 rpm
 - Maks. lastik ağırlığı: 30 kg.
- Kolay, hızlı menü ve grafikler
- Bütün kurşun tiplerini tanıyabilme özelliği



FASEP B150T

kod.10 04 B150T

- Mobil ağır vasıta araç lastik servisleri için balans makinası
 - Motorsuz Dijital ekranlı
 - Jant ölçüsü: 8"-26"
 - Jant genişliği: maks. 16"
 - Lastik ölçüsü: 49"
 - Lastik dönüş hızı: 75-125 rpm
 - Maks. lastik ağırlığı: 30 kg.
 - Kolay, hızlı menü ve grafikler
- Bütün kurşun tiplerini tanıyabilme özelliği

FASEP NO CONTACT

kod. 10 04 NO CON

- Yenilikçi, temassız ön düzen ayar robotu
- NoContact System ile çalışma şeklinizde devrim yapabilirsiniz.
- Tekerlek üzerinde hedef gerekmez
- Aracı ileri geri hareket ettirmeye gerek yok
- Kızılötesi teknolojile karşılaştırılabilir ölçüm doğruluğu (geleneksel 3D hassasiyetinden çok daha iyi)
- Kameraların otomatik olarak konumlandırır

FASEP



FASEP V643 G3

kod. 10 04 V 643

- 20" LCD ekran, •Windows Mobile
- Otomatik dıştan ölçüm kolu
- Jant ölçüsü: 8"-26"
- Jant genişliği: maks. 16"
- Lastik ölçüsü: 34"
- Lastik dönüş hızı: 98 rpm
- Maks. lastik ağırlığı: 90 kg.
- Havalı otomatik lastik kilitleme
- Lazerle kurşun montaj yerini gösterme
- Kolay, hızlı Türkçe menü ve grafikler
- Bütün kurşun tiplerini tanıyabilme özelliği

FASEP



FASEP V585 G3

kod. 10 04 E585 G3 LASER

- 20" LCD ekran, • Windows Mobile
- Otomatik dıştan ölçüm kolu
- Jant ölçüsü: 8"-26"
- Jant genişliği: maks. 16"
- Lastik ölçüsü: 34"
- Lastik dönüş hızı: 98 rpm
- Maks. lastik ağırlığı: 90 kg.
- Lazerle kurşun yerini gösterme
- Kolay, hızlı Türkçe menüler
- Bütün kurşun tiplerini tanıyabilme

FASEP



FASEP V555

kod. 10 04 E555

- 20" LCD ekran
- Jant ölçüsü: 8"-26"
- Jant genişliği: maks. 16"
- Lastik ölçüsü: 34"
- Lastik dönüş hızı: 98 rpm
- Maks. lastik ağırlığı: 90 kg.
- Kolay, hızlı Türkçe menü ve grafikler
- Bütün kurşun tiplerini tanıyabilme özelliği

FASEP



CROCODILLE JACKS TİMSAH KRİKOLAR



Size
Ebat

2 ton	1180x140x800mm
2 ton low profile	1310x120x590mm
3 ton	1420x140x560mm
5 ton	1550x150x560mm
10 ton	1430x180x670mm



3 TONS LOW

kod.

- Low profile trolley jacks
- Lifting capacity: 3 ton
- Lifting height: 440 mm
- Min. height: 76 mm
- Weight: 44 kg
- Overall size: 600x90x460 mm
- Alçak profilli arabalı krika
- Kaldırma kapasitesi: 3 ton
- Kaldırma yüksekliği: 440 mm
- Min. yükseklik: 76 mm
- Ağırlık: 44 kg
- Ebatlar: 600x90x460 mm



JACK STAND KRİKO SEHPASI

- kod.05 03 T412002 12 ton
- kod.05 03 T46002 6 ton
- kod.05 03 T43002 3 ton

MICHELIN MCX981 N

kod.13 EE 6603B

- Mobil servisler için hizmet ünitesi
- 2 silindiri
- 17 hp
- Su soğutmalı dizel motor
- 12,5 kVA jeneratör
- Akü
- 22 lt yakıt tankı
- Endüstriyel dizel yakıt filtresi
- 90 LT 12 bar kompresör tankı
- Şartlandırıcı
- Trifaze ve monofaze elektrik priz çıkışları
- İki adet 16 ve 21 m hava makarası



FIAC MSU 981

kod.13 EE 6603B

- Mobil servisler için hizmet ünitesi
- 2 silindiri
- 17 hp
- Su soğutmalı dizel motor
- 12,5 kVA jeneratör
- Akü
- 22 lt yakıt tankı
- Endüstriyel dizel yakıt filtresi
- 90 LT 12 bar kompresör tankı
- Şartlandırıcı
- Trifaze ve monofaze elektrik priz çıkışları
- İki adet 16 ve 21 m hava makarası





MICHELIN MCX

- Double piston twin stage
- Çift pistonlu çift kademeli

	Volt hz/ph	tank lt	lt/min	cfm	bar	psi	hp	kW
MCX 200/550S	400/50/3	200	550	19,4	10/14	145/203	5,5	4
MCX 300/550S	400/50/3	270	550	19,4	10/14	145/203	5,5	4
MCX 500/850S	400/50/3	500	830	29,3	10/14	145/203	7,5	5,5



MICHELIN MCX

- Silent air compressors (Non tank)
- Pistonlu sessiz hava kompresörleri (Deposuz)

	Volt hz/ph	tank lt	lt/min	cfm	bar	psi	hp	kW
MCX 981 N	400/50/3	-	912	32,3	10/14	145/203	10	7,5



MICHELIN MCX

- Silent air compressors
- Pistonlu sessiz hava kompresörleri

	Volt hz/ph	tank lt	lt/min	cfm	bar	psi	hp	kW
MCX 981/300 N	400/50/3	270	912	32,3	10/14	145/203	10	7,5
MCX 981/500 N	400/50/3	500	912	32,3	10/14	145/203	10	7,5



FIAC AB

- Double piston twin stage
- Çift pistonlu çift kademeli



	Volt hz/ph	tank lt	lt/min	cfm	bar	psi	hp	kW
AB 200/3	400/50/3	200	250	-	10	145	3	-
AB 300/550S	400/50/3	270	550	19,4	10/14	145/203	5,5	4
AB 500/850S	400/50/3	500	830	29,3	10/14	145/203	7,5	5,5



FIAC SCS

- Silent air compressors
- Pistonlu sessiz hava kompresörleri



	Volt hz/ph	tank lt	lt/min	cfm	bar	psi	hp	kW
SCS 981/300 N	400/50/3	270	912	32,3	10/14	145/203	10	7,5
SCS 981/500 N	400/50/3	500	912	32,3	10/14	145/203	10	7,5



FIAC CRS

- Screw compressors (Non tank)
- Vidali kompresörler (Deposuz)



	Volt hz/ph	tank lt	lt/min	cfm	bar	psi	hp	kW
CRS 20	400/50/3	-	2010	70,9	13	116/189	20	15



FIAC CRS

- Screw compressors
- Vidali kompresörler



	Volt hz/ph	tank lt	lt/min	cfm	bar	psi	hp	kW
CRS 20/500	400/50/3	500	2010	70,9	13	116/189	20	15





PCL D13

kod.30 08 D-13

- Car and trucks
- Digital display
- 4 outputs
- Binek araçlar ve ağır vasıta
- Dijital ekranlı
- 4 çıkışlı



PCL D12

kod.30 08 D-12

- Car and trucks
- Digital display
- Binek araçlar ve ağır vasıta
- Dijital ekranlı



PCL A10

kod.30 08 A-10

- Car and light trucks
- Analog display
- Binek araçlar ve hafif ticari araçlar
- Analog ekranlı



PCL D10

kod.30 08 D-10

- Car and light trucks
- Digital display
- Binek araçlar ve hafif ticari araçlar
- Dijital ekranlı



PCL D60

kod.30 08 D-60

- Car and light trucks
- Digital display
- Binek araçlar ve hafif ticari
- Dijital ekranlı

PCL AIRFORCE

kod.30 08 00002AF

- Analog display
- Analog ekranlı



PCL MK-3

kod.30 08 00002MK-3

- Analog display
- Metal body
- Analog ekranlı
- Metal gövde



PCL MK-4

kod.30 08 00002MK-4

- Digital display
- Metal body
- Dijital ekranlı
- Metal gövde



JAMEC PEM AUTO 1000

kod.07 00

- Otomatik Hava Saati
- Arka Aydınlatmalı Dijital LCD ekran
- Maksimum Hava Çıkışı 12 bar /1200 kPa / 174 p.s.i. / 12 kgF
- Hava Basınç Kapasitesi 2500 L / dk
- Ölçüm Hassasiyeti +/- 0,3 psi
- 1/4" Hortum Bağlantı Çapı
- Maksimum Hava Bağlantı Basıncı 182 p.s.i.
- Otomatik Basınç Yükseltme / Düşürme
- OPS (Otomatik Lastiğin Janta Oturma Basınç Ayarı)
- 1,5m Hortum Uzunluğu



ATEK AIR HOSE REEL 1/2"

kod.16 OR 20115

- 12m hose
- Rewind,
- Metal body
- 12m hortum
- Geri sarma,
- Metal gövde





KUKEN 430P 1"

kod.38 KK 430P

- 1"
- 2200 Nm tork
- 4300 rpm



KUKEN KW-T160V EVO

kod.38 KW 160EVO

- 1/2"
- 660 Nm tork
- 6300 rpm
- Ultra sessiz (78dB)



KUKEN 19HP 1/2"

kod.38 KK 430P

- 1/2"
- 450 Nm tork
- 6000 rpm



KUKEN 2500 PRO 3/4"

kod.38 KSE 2500 PRO

- 3/4"
- 980 Nm tork
- 4,500 rpm



1" MECHANICAL IMPACT WRENCH

1" MEKANNİK BİJON ANAHTARI

kod.05 03 TRX3102



MOUNTING PASTE

MONTAJ KREMI

- kod.EC 01 MK05 White / Beyaz 5kg
- kod.OZ 01 SARI Yellow / Sarı 5kg

SOCKET BOX SETS LOKMA SETİ KUTULU

- kod.SC 015 06** 1" long, 8 Pcs 24-41 mm 1" uzun, 8 Parça 24-41 mm
kod.SC 009 05 1" short, 8 Pcs 24-41 mm 1" kısa, 8 Parça 24-41 mm
kod.SC 003 04 3/4" short, 8 Pcs 21-38 mm 3/4" kısa, 8 Parça 21-38 mm
kod.SC 003 04 1/2" short, 10 Pcs 10-24 mm 1/2" kısa, 10 Parça 10-24 mm



SOCKETS LOKMALAR

- 1" long 1" uzun: 24,27,30,32,33,35,38,41 mm
- 1" short 1" kısa: 24,27,30,32,33,35,38,41 mm
- 1/2" short 1/2" kısa: 17,19,21,22,23,24 mm



TOPTUL 1/2"

kod.TT GDAI 0301

- 3 Pcs Sockets with alu rims 17-19-21mm
- 5 Parça alüminyum jantlar için lokma 17-19-21mm



KENT OIL PUMPS

- 16 OC 41175 Yağ çekme ve toplama cihazı fanuslu hunili
- 16 OC 40175 Yağ çekme cihazı 75 lt fanussuz
- 16 OC 42275 Yağ çekme ve toplama cihazı fanussuz hunili
- 16 OD 40275 Yağ çekme ve toplama cihazı fanussuz hunili
- 16 OD 44075 Yağ çekme cihazı tavalı 14lt 75lt tank
- 16 OD 44120 Yağ çekme cihazı tavalı 50lt 120lt tank
- 16 OD 43030 Manuel yağ dolm cihazı 30lt
- 16 OD 43130 Havali yağ dolm cihazı 30lt
- 16 OD 43275 Pompalı yağ dolm cihazı dijital tanabcalı
- 16 OD 40075 Yağ çekme cihazı 75lt hunisiz
- 16 OG 36200 Yağ dolm tabancası dijital sayaçlı
- 16 GM 55015 Havali gres 15 kg
- 16 GM 55130 Havali gres 30 kg
- 16 OR 28000 Açık yağ makarası
- 16 AT 28020 Hava reali 20m hortumlu
- 16 OP 31094 Yağ pompası 3/l
- 16 OP 51094 Yağ pompası 5/l
- 16 GP 50194 Gres pompası





kod.29 02 0414ALG
kod.29 02 0414ES
kod.29 02 0414E
kod.29 02 0414

TR 414

TR 414 ALLIGATOR
TR 414 EHA S
TR 414 EHA
TR 414



TR 414 METAL / EĞİMLİ METAL

kod.29 04 00414D
kod.29 04 004148

TR 414 Metal
TR 414 Eğimli metal



BMW UZUN SOMUN İNCE

kod.29 20 01416 Bmw uzun ince tip sibop



TUBELESS AĞIR VASITA SİBOPLARI

kod.26 01 01019 Uzun Somunlu Jant Sibobu
kod.29 01 01004 Tüb. Kam. Metal 4 cm
kod.29 01 01005 Tüb. Kam. Metal 5 cm
kod.29 01 01007 Tüb. Kam. Metal 7 cm
kod.29 01 01009 Tüb. Kam. Metal 9 cm
kod.29 01 01011 Tüb. Kam. Metal 11,5 cm
kod.29 01 01013 Tüb. Kam. Metal 13 cm
kod.29 01 01015 Tüb. Kam. Metal 15 cm
kod.29 01 01018 Tüb. Kam. Metal 18 cm



TUBELESS AĞIR VASITA SİBOPLARI

kod.29 12 00003C Pilot tubeless sibop
kod.29 12 00005 İş mak. sibobu TR-5720 dorse



TUBELESS İŞ MAKİNASI SİBOPLARI

kod.29 01 01618 İş mak. sibobu kauçuk dipli
kod.29 01 00618 Traktör tubeless metal sibop

HOFMANN NORMAL

5 gr	kutuda 100 adet
10 gr	kutuda 100 adet
15 gr	kutuda 100 adet
20 gr	kutuda 100 adet
25 gr	kutuda 100 adet
30 gr	kutuda 100 adet
35 gr	kutuda 100 adet
40 gr	kutuda 100 adet
45 gr	kutuda 50 adet
50 gr	kutuda 50 adet
55 gr	kutuda 50 adet
60 gr	kutuda 50 adet



HOFMANN TURBO

5 gr	kutuda 100 adet
10 gr	kutuda 100 adet
15 gr	kutuda 100 adet
20 gr	kutuda 100 adet
25 gr	kutuda 100 adet
30 gr	kutuda 100 adet
35 gr	kutuda 100 adet
40 gr	kutuda 100 adet
45 gr	kutuda 50 adet
50 gr	kutuda 50 adet
55 gr	kutuda 50 adet
60 gr	kutuda 50 adet



HOFMANN TRUCK / KAMYON

50 gr	kutuda 10 adet
100 gr	kutuda 10 adet
150 gr	kutuda 10 adet
200 gr	kutuda 10 adet
250 gr	kutuda 10 adet
300 gr	kutuda 10 adet
350 gr	kutuda 10 adet



HOFMANN ADHEDICVE / YAPIŞTIRMA

60 gr Slim	kutuda 100 adet
60 gr Slim Metal	kutuda 50 adet



TRUCK TYRE SIDEWALL SEPARATING AĞIR VASITA LASTİK YANAK AÇICI

kod.

- Working pressure of 8-10bar
- Light illumination
- Easy and fast to use
- 8-10 bar çalışma basıncı
- Işıklı aydınlatma
- Kolay ve hızlı kullanım



TYRE SIDEWALL SEPARATING LASTİK YANAK AÇICI

kod.KTJ-658

- Working pressure of 8-10bar
- Light illumination
- Easy and fast to use
- 8-10 bar çalışma basıncı
- Işıklı aydınlatma
- Kolay ve hızlı kullanım



TRUCK AND BUS TYRE LIFTING AĞIR VASITA LASTİK ASANSÖRÜ

kod.

- Working pressure of 8-10bar
- 300 kg Tyre Lifting
- Easy and fast to use
- 8-10 bar çalışma basıncı
- 300 kg Lastik Kaldırma gücü
- Kolay ve hızlı kullanım



CORGI UNIFORMITY 32"

- Anza tespitli lastik sökme takma makinası
- Levyesiz lastik sökme takma
- 32" Jant çapı
- 47" Lastik çapı
- Röleli
- Dijital ekranlı
- Lazer ile jant ve lastik hatalarını tarama
- Elektrikli göbekten jant bağlamalı
- Lastik kaldırma asansörlü
- Çift yanak düşürme kolu
- Çift devirli
- Dijital lastik dış derinlik ölçüleri
- Her türlü otomobil ve 4x4 arazi taşıtlarına uygun
- Opsiyonel lastik kaldırma asansörü
- Hava basıncı 8-10 bar
- 380 kg makina ağırlığı

- Diagnostik özellikli 32" e kadar olan binek araç, SUV ve hafif ticari araçlar için sökme takma makinası.
- Normal lastik sökme takma işleminin yanında detaylı olarak 28" e kadar olan jant ölçülerinde yüksüz ve yüklü yol koşullarını simüle ederek lastik ve jantın geometrik analizlerini yapar.
- Lastiğin üstün konfor ve performans sağlanması için uygun lastik ve jant pozisyonlamasını gösterir (Match Mounting)
- Simülasyon silindiri işlem sırasında lastiğin gerçek yol koşullarındaki yanak ve dikey kuvvetleri uygulamak için tasarlanmıştır.
- Yüksek poligonlu lazer tarayıcı ile jant ve lastikteki geometrik ölçümleri yapar.
- Navigasyon sistemli multifonksiyon konsolu ile menülerde hızlı ve kolay kullanım sağlar.
- Lastik damak düşürme disklerinin her biri çift yönlü kırma hareketiyle en sert lastikler bile üstün performans sağlar.
- Her tip tekerlek için hassas merkezleme yapabilen özel bağlantı tasarımı.
- 85kg kaldırma kapasiteli lastik asansörü

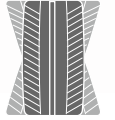

WHEEL
DIAGNOSIS

Pos
INTELLIGENT
POSITIONING

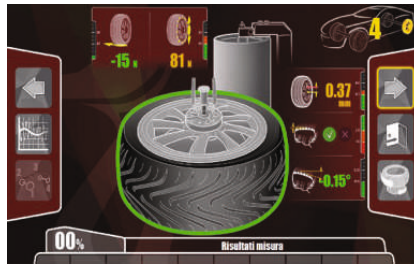

Bu ürün, bu markalar tarafından akredite edilmiştir.





CORGHI MASTER CODE 32"



- 32" Jant çapı
- 47" Lastik çapı
- Kameralı
- Lazer ile tarama
- Dokunmatik ekranlı
- Otomatik sıvı montaj kremi püskürtme
- Elektrikli göbekten jant bağlamalı
- Lastik kaldırma asansörlü
- Otomatik lastik damak düşürme
- Otomatik hava basınç dolumu
- Araç modeline göre sibop sensör algılama
- Lastik yüzeyinin sıcaklığını ölçme
- Dijital lastik dış derinlik ölçüleri
- Tam otomatik insansız sökme takma
- Her türlü otomobil ve 4x4 arazi taşıtlarına uygun
- Lastiği sadece makinaya monre edin,
- Dokunmatik ekrandan başlatın ve
- Sadece artiglio master code yi seyredin.
- Hava basıncı 8-10 bar
- Maksimum 85 kg lastik ağırlığı
- 95 kg makina ağırlı
- Ebatlar: 1760x2187x1840mm



- Master Code dört farklı metod ile lastik özelliğine bağlı olarak sökme takma işlemini tam otomatik olarak gerçekleştirir.
- Master Code bu metodlar ile sökme takma işlemi sırasında Run-Flat, UHP ve Balon tipi lastikler de dahil olmak üzere bütün lastik tiplerine ve jantlara asla hasar vermemeden görevini başarıyla yapar.
- SMART CORGHI SYSTEM teknolojsi ile otomatik leveye ve damak düşürme silindirleri asla janta temas etmez.
- Master Code lazer teknolojsi ile jant ve lastik ölçülerini otomatik algılar.
- Otomatik sökme takma işlemi sırasında sıvı lastik montaj kremi kendisi püskürterek işlemini gerçekleştirir.
- TFT-LCD dokunmatik ekranı ile bütün otomatik işlemler ve menüler tek noktadan hızlıca gerçekleştirilir.
- Otomatik hava basınç sistemiyle lastiği şişirme işlemi basit bir şekilde tamamlar.
- TPMS algılama ve tüm teknik verilerini gösterir.
- Yeni nesil tork kontrollü elektrik motoru ile saat yönü ve tersi yönünde hız kontrollü sağlanabilir.
- Dijital dış derinlik ölçümü
- Lastik yüzey sıcaklık kontrolü ile RUN-FLAT ve UHP lastiklerde tavsiye edilen güvenli sökme sıcaklığını tespit edebilir.
- Lastik damak düşürme disklerinin her biri çift yönlü kırma hareketiyle en sert lastikler bile üstün performans sağlar.
- Her tip tekerlek için hassas merkezleme yapabilen özel bağlantı tasarımı.



Bu ürün, bu markalar tarafından akredite edilmiştir.



CORGHI ARTIGLIO MASTER MI 26"

- 12 "-26" lastik sökme ebadı
- Lastik kaldırma asansörü
- Çift devirli hava saati
- Yeni hızlı performansı arttırılmış üniversal lastik bağlama sistemi
- Otomatik PAX sistem lastik seçimi
- Dijital hava Saati
- Her türlü otomobil ve 4x4 Arazi taşıtlarına uygun
- 65 kg maksimum lastik ağırlığı
- Hava basınç 8-10 bar
- 465 kg makina ağırlığı
- Ebatlar: 1300x2100x1600 mm



Bu ürün, bu markalar tarafından akredite edilmiştir.



CORGHI ARTIGLIO MASTER JOLLY 26"

- 12 "-26" lastik sökme ebadı
- Lastik kaldırma asansörü
- Çift devirli hava saati
- Otomatik göbekten sıkmalı
- Yeni hızlı performansı arttırılmış üniversal lastik bağlama sistemi
- Otomatik pax sistem lastik seçimi
- Dijital hava saati
- Her türlü otomobil ve 4x4 arazi taşıtlarına uygun
- 65 kg maksimum lastik ağırlığı
- Hava basınç 8-10 bar
- 465 kg makina ağırlığı
- Ebatlar: 1134x1844x1904 mm



Bu ürün, bu markalar tarafından akredite edilmiştir.



CORGHI ARTIGLIO MASTER JOLLY 26"

- 12 "-26" lastik sökme ebadı
- Lastik kaldırma asansörü
- Çift devirli hava saatli
- Yeni hızlı performansı arttırılmış üniversal lastik bağlama sistemi
- Otomatik pax sistem lastik seçimi
- Dijital hava saati
- Her türlü otomobil ve 4x4 arazi taşıtlarına uygun
- 65 kg maksimum lastik ağırlığı
- Hava basıncı 8-10 bar
- 465 kg makina ağırlığı
- Ebatlar: 1134x1844x1904 mm



Bu ürün, bu markalar tarafından akredite edilmiştir.



CORGHI ARTIGLIO 5000 26"

- 12 "-26" lastik sökme ebadı
- Lastik kaldırma asansörü
- Çift devirli hava saatli
- Yeni hızlı performansı arttırılmış üniversal lastik bağlama sistemi
- Otomatik pax sistem lastik seçimi
- Dijital hava saati
- Her türlü otomobil ve 4x4 arazi taşıtlarına uygun
- 65 kg maksimum lastik ağırlığı
- Hava basıncı 8-10 bar
- 465 kg makina ağırlığı
- Ebatlar: 1134x1844x1904 mm



Bu ürün, bu markalar tarafından akredite edilmiştir.



CORGHI ARTIGLIO 500 32"

- "Levyesiz" özellikteki full otomatik lastik sökme takma makinası
- Göbekten sıkmalı levyesiz sistem
- 32" janta kadar lastik söküp takabilme
- Çift yanak düşürme kolu
- Çift devirli, 85 kg maksimum lastik ağırlığı
- 380 kg makina ağırlığı
- Hava saati
- 230v monofaze hava basıncı 8 bar
- Standart lastik kaldırma asansörü
- Ebatlar: 1290x1700x2000mm



Bu ürün, bu markalar tarafından akredite edilmiştir.



CORGHI ARTIGLIO 55 30"

- "Levyesiz" özellikteki full otomatik lastik sökme takma makinasıdır.
- Mobil servisler için
- 30" janta kadar lastik söküp takabilme
- Tek yanak düşürme kolu

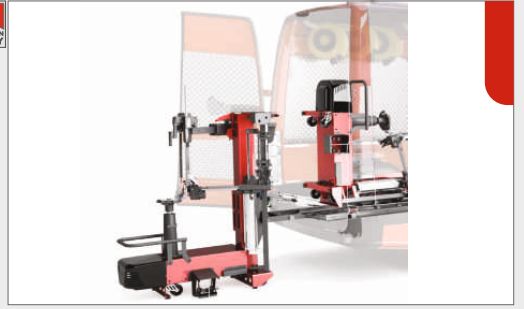

CORGHI ARTIGLIO 50 30"

- "Levyesiz" özellikteki full otomatik lastik sökme takma makinasıdır.
- Göbekten sıkmalı levyesiz sistem
- 30" janta kadar lastik söküp takabilme
- Tek yanak düşürme kolu
- Çift devirli
- 85 kg maksimum lastik ağırlığı
- 380 kg makina ağırlığı
- Hava saati
- 230v monofaze hava basıncı 8 bar
- Opsiyonel lastik kaldırma asansörü
- Ebatlar: 1290x1500x2000mm
- Yeni nesil tork kontrollü elektrik motoru ile saat yönü ve tersi yönünde hız kontrollü sağlanabilir.
- Lastik damak düşürme disklerinin her biri çift yönlü kırma hareketiyle en sert lastikler bile üstün performans sağlar.
- Her tip tekerlek için hassas merkezleme yapabilen özel bağlantı tasarımı.
- Hava basınç sistemiyle lastiği şişirme işlemini basit bir şekilde tamamlar.
- 85kg kaldırma kapasiteli opsiyonel lastik asansörü



Bu ürün, bu markalar tarafından akredite edilmiştir.





CORGHI A2025 LL 26"

- 26" lastik ebadı
- Full otomatik
- Kare döner tablalı
- Kafa arkaya yatma özelliği
- Opsiyonel çift devirli
- Levyesiz sistem
- Opsiyonel şoklama sistemli
- Opsiyonel performans lastikleri için yardımcı kol
 - Hava basıncı 8-10 bar,
 - 259kg makine ağırlığı
 - Ebatlar: 1090x1865x1700mm
- Lastik genişliğine göre ayarlanabilir damak düşürme mekanizması

Bu ürün, bu markalar tarafından akredite edilmiştir.



CORGHI A2030 26"

- 26" Lastik Ebadı
- Full Otomatik
- Kare Döner Tablalı
- Kafa Arkaya Yatma Özelliği
- Opsiyonel Çift Devirli
- Opsiyonel Şoklama Sistemli
- Opsiyonel Performans Lastikleri İçin Yardımcı Kol
 - Yüksekliği Ayarlanabilir Damak Düşürme Kolu
 - 259kg Makine Ağırlığı
 - Ebatlar: 1240x1840x1770mm
- Lastik genişliğine göre ayarlanabilir damak düşürme mekanizması

Bu ürün, bu markalar tarafından akredite edilmiştir.



Servis & Garaj Ekipmanları

CORGHI A2025 24"

- 24" lastik ebadı
- Full otomatik, kare döner tablalı
- Kafa arkaya yatma özelliği
- Opsiyonel çift devirli
- Opsiyonel şoklama sistemli
- Opsiyonel performans lastikleri için yardımcı kol
- 259kg makine ağırlığı
- Ebatlar: 1090x1700x1835mm
- Lastik genişliğine göre ayarlanabilir, damak düşürme mekanizması

Bu ürün, bu markalar tarafından akredite edilmiştir.



CORGHI A224 26"

- 26" lastik ebadı
- Tam otomatik, opsiyonel çift devirli
- Opsiyonel şoklama sistemli
- Opsiyonel performans lastikleri için yardımcı kol
- 255kg makine ağırlığı
- Ebatlar: 1090x1700x1835mm

Bu ürün, bu markalar tarafından akredite edilmiştir.

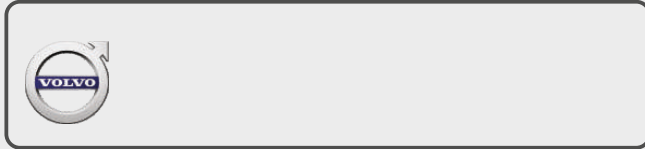

CORGHI BC 200S 23"

- 5"-23" lastik ebadı
- 6"-16" lastik ebadı opsiyonel atv için adaptörü
- Yarı otomatik
- Motorsiklet, scooter, go-kart, bahçe makinalarına uyumlu





CORGHI MONSTER AG TT 14"-58"



- 14"-58" lastik ebadı
- Maksimum lastik çapı: 2500mm
- Maksimum lastik genişliği: 1600mm
- Maksimum lastik ağırlığı: 1700-2500kg
 - Üç devirli
 - Levyesiz sistem
- Standart kablosuz kontrol ünitesi
- Otomatik dönen çampara ve gaga
 - 1300kg makine ağırlığı
- Ebatlar: 2400x2200x1800mm



CORGHI AG TT 1600A 14"-58"

- 14"-58" lastik ebadı
- Maksimum lastik çapı: 2500mm
- Maksimum lastik genişliği: 1600mm
- Maksimum lastik ağırlığı: 1700-2500kg
 - Üç devirli
 - Levyesiz sistem
- Opsiyonel kablosuz kontrol ünitesi
- Otomatik dönen çampara ve gaga
 - 1300kg makine ağırlığı
- Ebatlar: 2400x2200x1800mm



CORGHI HD 1400 11"-56"

- 11"-56" lastik ebadı
- Maksimum lastik çapı: 2500mm
- Maksimum lastik genişliği: 1470mm
- Maksimum lastik ağırlığı: 1200kg
 - Üç devirli
- Opsiyonel kablosuz kontrol ünitesi
- Otomatik dönen çampara ve gaga
 - 1160kg makine ağırlığı
- Ebatlar: 2540x2060x1770mm

CORGI EYELIGHT PLUS 32"

DIAGNOSTICLINE



- 23" dokunmatik ekranlı lcd ekran
- Otomatik davlumbaz açma
- 3d lastik ve jant tarama
- Otomatik jant ve lastik ebat ölçümü
- Balans hassasiyeti: 1gr balans süresi:6 s
- Maksimum jant çapı:32"
- Maksimum lastik genişliği:600mm 23,6"
- Maksimum lastik çapı:1117mm / 44"
- Maksimum lastik ağırlığı:75kg
- Sınıfının en hızlısı 6sn de balans ölçümü
- Yüksek hassasiyetli tft-lcd dokunmatik ekranı ile menülerde kaybolmadan Hızlıca cihazın yönetimi
- Otomatik olarak janta uygun kurşun programını belirler
- Lazer ile lastik ve jant yüzeyindeki hataları tarama
- Tek ölçüm ile jant ve lastiği ayrı olarak deformasyonunu Raporlama (eğrilik, yalpa, salgi, merkezden kaçıklık)
- Aracın bütün lastiklerinin ölçümü sonrasında ön düzen Ayan gereksinimini ve çekme eğrisini-yönünü gösterir.
- Kurşun yerini noktasal lazer ile gösterir.
- Aracın bütün lastiklerinin ölçümü sonrasında lastik desenine bağlı olarak araç üzerinde lastiklerin hangi aks yönünde en uygun montajlama önerisi verir
- Aracın tekerleklerinde yapılan tüm ölçümlerin detaylı raporunu verir
- Yüksek performans araçları için ultra hassas ölçüm modu
- Tek balans makinası ile aynı anda dört operatöre tekrar ölçü almadan farklı ebat lastiklerde hızlı şekilde balans yapma modu



Bu ürün, bu markalar tarafından akredite edilmiştir.





CORGI EM 9980 C PLUS 32" DIAGNOSTICLINE

- Full otomatik jant ölçüsü ve tipini belirleme
 - Kurşun programı seçmeye son
- Kameralı lazer ile kurşun yerini gösterme
 - Elektromekanik lastik kilitlemeli
- 23" dokunmatik ekranlı lcd ekran
 - Otomatik davlumbaz açma
- Otomatik jant ve lastik ebat ölçümü
- Balans hassasiyeti : 1 g balans süresi: 6 s
 - Maksimum jant çapı: 32"
- Maksimum lastik genişliği: 600mm 23,6"
 - Maksimum lastik çapı: 1117mm/44"
 - Maksimum lastik ağırlığı: 75kg
- Sınıfının en hızlısı 6sn de balans ölçümü
- Yüksek hassasiyetli tft-lcd dokunmatik ekranı ile menülerde kaybolmadan hızlıca cihazın yönetimi
- Otomatik olarak janta uygun kurşun programını belirler
 - Lazer ile lastik yüzeyindeki hataları tarama ve grafik olarak raporlama
 - Kurşun yerini noktasal lazer ile gösterir.
- Aracın bütün lastiklerinin ölçümü sonrasında lastik desenine bağlı olarak araç üzerinde lastiklerin hangi aks yönünde en uygun montajlama önerisi verir
 - Aracın tekerleklerinde yapılan tüm ölçümlerin detaylı raporunu verir
 - Yüksek performans araçları için ultra hassas ölçüm modu
- Tek balans makinası ile aynı anda dört operatöre tekrar ölçü almadan farklı ebat lastiklerde hızlı şekilde balans yapma modu

Bu ürün, bu markalar tarafından akredite edilmiştir.



CORGI EM 9780 C PLUS 32" DIAGNOSTICLINE

- 6sn de balans ölçümü
- Sonar sistemli otomatik jant ölçümü,
- Joystik ile kolay ve hızlı menü kullanımı
 - Lazer ile kurşun yerini gösterme
 - Elektromekanik lastik kilitlemeli
 - 20" lcd ekran
- Otomatik davlumbaz açma
- Otomatik jant ve lastik ebat ölçümü
- Balans hassasiyeti: 1gr balans süresi: 6 s
 - Maksimum jant çapı: 28"
- Maksimum lastik genişliği: 600mm 23,6"
 - Maksimum lastik çapı: 1117mm/44"
 - Maksimum lastik ağırlığı: 75kg

Bu ürün, bu markalar tarafından akredite edilmiştir.



CORGHI EM 9580 C PLUS 28"



- 6sn de balans ölçümü
- Sonar sistemli otomatik jant ölçümü,
- Joystik ile kolay ve hızlı menü kullanımı
- Lazer ile kurşun yerini gösterme
- Elektromekanik lastik kilitlemeli
- 20" lcd ekran
- Otomatik davlumbaz açma
- Otomatik jant ve lastik ebat ölçümü
- Balans hassasiyeti: 1gr balans süresi:6 s
- Maksimum jant çapı: 28"
- Maksimum lastik genişliği: 600mm 23,6"
- Maksimum lastik çapı: 1117mm/44"
- Maksimum lastik ağırlığı: 75kg



Bu ürün, bu markalar tarafından akredite edilmiştir.



CORGHI EM 9380/9380 C 32"



- Dıştan otomatik ölçüm
- Havalı lastik kilitleme (9980 c)
- 20" lcd ekran
- Otomatik jant ve lastik ebat ölçümü
- Balans hassasiyeti: 1 gr
- Balans süresi: 7 sn
- Maksimum jant çapı: 28"
- Maksimum lastik genişliği: 600mm/ 23,6"
- Maksimum lastik çapı: 1117mm/44"
- Maksimum lastik ağırlığı: 75kg



Bu ürün, bu markalar tarafından akredite edilmiştir.

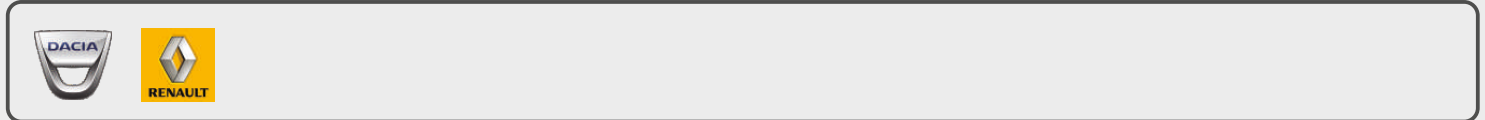

CORGHI EM 9280/9280 C 28"

- 20 lcd ekran
- Balans hassasiyeti: 1 g
- Balans süresi: 6 s
- Maksimum jant çapı: 28"
- Maksimum lastik genişliği: 600mm/23,6"
- Maksimum lastik çapı: 1117mm/44"
- Maksimum lastik ağırlığı: 75kg



Bu ürün, bu markalar tarafından akredite edilmiştir.



CORGHI PROLINE 680 28"

- 20 lcd ekran
- Balans hassasiyeti: 1 g
- Balans süresi: 6 s
- Maksimum jant çapı: 28"
- Maksimum lastik genişliği: 600mm / 23,6"
- Maksimum lastik çapı: 1117mm / 44"
- Maksimum lastik ağırlığı: 75kg



CORGHI ET88 30"

- Binek lastik balans hızı 120rpm
- Kamyon lastik balans hızı 80 rpm
- Maksimum takılabilen kurşun ağırlığı 2000gr
- Balans hassasiyeti 1gr
- Binek araç lastik jant ölçüsü: 12"-30"
- Ağır vasıta lastik jant ölçüsü: 12"-30"
- Maksimum tekerlek makine mesafesi: 400mm
- Maksimum tekerlek genişliği: 700mm
- Maksimum tekerlek çapı: 1380mm
- Maksimum Tekerlek ağırlığı: 200 kg
- 255kg Makine Ağırlığı



CORGI REMO COMPACT DUO



DÜNYADA İLK ROBOT TEKNOLOJİSİ İLE HER TÜRLÜ JANT VE LASTİĞE TEMAS ETMEDEN HASSAS BİR ŞEKİLDE ANALİZ EDER

R.E.M.O. TEKNOLOJİSİ

- Lastik ve janta herhangi bir bağlantı olmadan çalışan bu teknoloji ile jantları çizme ihtimaliniz olmaz.
- Binek ve hafif ticari araçlarda ön hazırlık olmadan hızlıca analize başlayın.

AVANTAJLARINIZ

- Nerdeyse tüm lift modellerinde kullanılabilir.
- Kullanıcı dostu olduğu için özel eğitilmiş personel ihtiyacınız olmaz.
- Temel araç bilgileri girildikten sonra R.E.M.O. başında beklemenize gerek duymazsınız.
- Dolayısıyla müşterilerinize daha fazla zaman ayırabilir ve satışlarınızı arttırabilirsiniz.
- Bu zaman tasarrufu ile yoğun işletmelerde veya yoğun lastik değişim sezonlarında avantaj sağlar.

GELECEĞİN SERVİSİ

- Hızlı ölçüm sayesinde aracın kabul aşamasında müşteriye aracıyla ilgili bilgiler verilebilir.
- Bu eşzamanlı bilgilendirme müşterilerinizin memnuniyetini katlayacaktır.



R.E.M.O. OPSİYONEL KİTLERİ



- 1 tablet
- 1 özel tablet uygulaması
- 1 adet tablet kokuma kılıfı
- 1 adet özel bağlantılar



- Opsiyonel Call One-Touch kiti istendiğinde ön-arka düzen ayarlama işlemi sırasında ESP, Adaptif araç yüksekliği, dinamik direksiyon, elektronik direksiyon sistemi ve yön değiştiren far sistemine aracın ECU sistemine bağlanarak değişiklikleri tanıtır



CORGHI REMO RAPIDE

- Birkaç saniyede RAPIDE, operatöre ihtiyaç duymadan ve janta dokunmadan aracın hizalama durumunu kontrol eder.
- Ek olarak, entegre yönetim sistemi sayesinde, alım adımı sırasında aracın tamamen kontrol edilmesi mümkündür (Akıllı Yönetim ile versiyon).

- RAPIDE verileri kolay bir şekilde yorumlaması ile müşteriye açıklamaları basitleştirir.
- RAPIDE otomatik olarak ön düzen hatalarını lastik diş derinliğini ve farları otomatik kontrol eder.
- Tüm sonuçları basitleştirilmiş renkli grafiklerle aracın durumu hakkında hızlı bilgi sahibi olursunuz.
- Aracın satışı sırasında durumu hakkında yardımcı olmak için büyük bir avantaj sağlar.
- Birkaç saniyede RAPIDE yaz / kış lastiği farketmeksizin müşteri ihtiyaçlarına göre lastik verimliliğini hakkında verilere hızlı ulaşım.



ENTEGRE TESTLER

- Tpms (lastik sensör kontrolü)
- Lastik profil tarama
- Jant analizi
- Far testi
- Batarya kontrolü



CORCHI EXACT BLACKTECH X PLUS



Kameralar liftin yukarı aşağı hareketine göre hareket eder. Sadece lift (XR) modelinde mevcuttur.

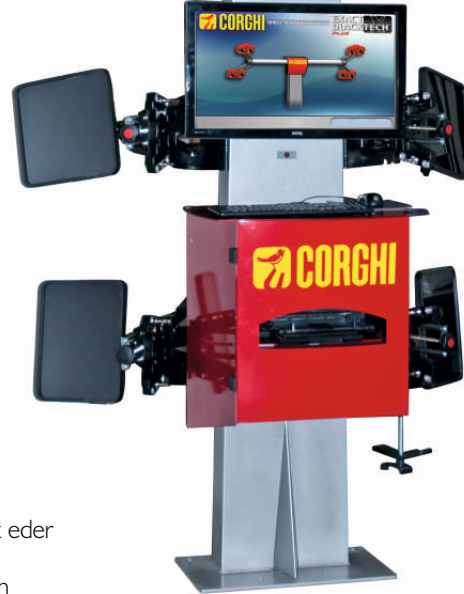
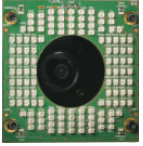

- Yüksek çözünürlüklü 8 adet Sony hassas kamera
- Kameraların pozisyonları daha önce programlanmış lift yüksekliğine hareket eder
- İhtiyaç duyulması durumunda kamera açıları manuel ayarlanabilir
- Özel algoritması sayesinde farklı ışık ortamlarında bile güvenilir hassas ölçüm
- Özel tasarlanan yansıtıcı aynalar yüksek teknoloji filtreleri sayesinde güneş ışınlarından etkilenmez
- Run-Out özelliği ile tekerlek ve aks deformasyonlarını hesaplar
- Ayarlama sırasında anlık değişen değerleri aynı anda gösterebilir
- Opsiyonel Call One-Touch sistemi istendiğinde ön-arka düzen ayarlama işlemi sırasında ESP, Adaptif araç yüksekliği, dinamik direksiyon, elektronik direksiyon sistemi ve yön değiştiren far sistemine aracın ECU sistemine bağlanarak değişiklikleri tanır
- Printer ile raporlamaları çıkış alma
- Exact BlackTech XPLUS yazılımı Windows tabanlıdır
- Exact BlackTech XPLUS yazılımında ön-arka düzen ayarlamalarını kolaylaştıran videoları ve açıklamalar
- Mercedes ve BMW için özel tasarlanmış ölçüm kafaları montaj bağlantıları
- Güncel Windows sürümü
- Opsiyonel Infrared uzaktan kumanda
- Pedal ve direksiyon kilitleme tertibatı
- Standart klavye mouse LCD monitör

Bu ürün, bu markalar tarafından akredite edilmiştir.



Jeep





CORGHI EXACT LINEAR

- 2 yüksek çözünürlüklü kamera
- 2 kamera sayesinde ölçüm hatası yok!
- Geniş açılar görebilmesi sayesinde hatasız ölçüm
- 4 adet kırılmaz dayanıklı bağlantı ayağı ve yansıtıcı
 - Bağlantı ayakları janta zarar vermez
 - Kolay ve hızlı kullanımlı arayüz
 - Hızlı ve hassas veri ölçümü
- Her türlü janta uyumlu veri okuma
 - Lift ya da çukur modelleri
- Türkçe menü ve türkçe raporlama



CORGHI EXACT 7000 PLUS II

- Bluetoothlu 8 Sensörlü
 - 4 Kafalı
 - Kablosuz
- 18000 araçlık databank
- Kolay ve hızlı kullanımlı arayüz
 - Hızlı ve hassas veri ölçümü
- Uzaktan kumandalı, pedal ve direksiyon kilit ayakları
 - Lcd ekranlı, yazıcı, mouse ve klavye seti
- Opsiyonel ağır vasıta araç databankı ve aparatları



Bu ürün, bu markalar tarafından akredite edilmiştir.



Servis & Garaj Ekipmanları

CORGHI EXACT 700 PLUS II



- Bluetoothlu 8 sensörlü
- 4 kafalı
- Kablosuz
- 18000 araçlık databank
- Kolay ve hızlı kullanımlı arayüz
- Hızlı ve hassas veri ölçümü
- Uzaktan kumandalı, pedal ve direksiyon kilit ayakları
- Lcd ekranlı,yazıcı,mause ve klavye seti
- Opsiyonel ağır vasıta araç databankı ve aparatları

Bu ürün, bu markalar tarafından akredite edilmiştir.



CORGHI EXACT 70 PLUS II



- Bluetoothlu 8 sensörlü
- 4 kafalı
- Kablosuz
- 18000 araçlık databank
- Kolay ve hızlı kullanımlı arayüz
- Hızlı ve hassas veri ölçümü, uzaktan kumandalı
- Pedal ve direksiyon kilit ayakları
- Lcd ekranlı, yazıcı, mause ve klavye seti
- Opsiyonel ağır vasıta araç databankı ve aparatları

Bu ürün, bu markalar tarafından akredite edilmiştir.



CORGHI EXACT 70 PLUS II



- Bluetoothlu 8 sensörlü
- 4 kafalı
- Kablosuz
- 18000 araçlık databank
- Kolay ve hızlı kullanımlı arayüz
- Hızlı ve hassas veri ölçümü
- Uzaktan kumandalı
- Pedal ve direksiyon kilit ayakları
- Lcd ekranlı,yazıcı,mause ve klavye seti
- Sadece binek ve hafif ticari araçlar

Bu ürün, bu markalar tarafından akredite edilmiştir.





CORGHI ERGO XC5500 / XC4500 CT LT

Makaslı Elektrohidrolik Lift

Döner Tablalı Makaslı Yavrulu Rot Lifti	ERGO XC5500 CT LT	ERGO XC4500 CT LT
Maksimum Yük Kapasitesi	5,5 Ton	4,5 Ton
Yavru Lift Yük Kapasitesi	4 Ton	4 Ton
Minimum Yükseklik	165 mm	165 mm
Maksimum Yükseklik	2020+500 mm	2040+500 mm
Lift Uzunluğu	4600 mm	4600 mm
Lift Geniřlięi	2160 mm	2160 mm
Elektronik Denge Kontrol Sistemi	✓	✓
Lift Yükseklięi Ayarlanabilir Dijital Ekran	✓	✓

Opsiyonel arka kayar tabla

Opsiyonel ön döner tabla

Standart analog ekranı sayesinde lift yüksekliğini gösterme ve tanımlanmış kullanıcı bazlı lift yüksekliği, durması istenen yüksekliği ayarlanabilir

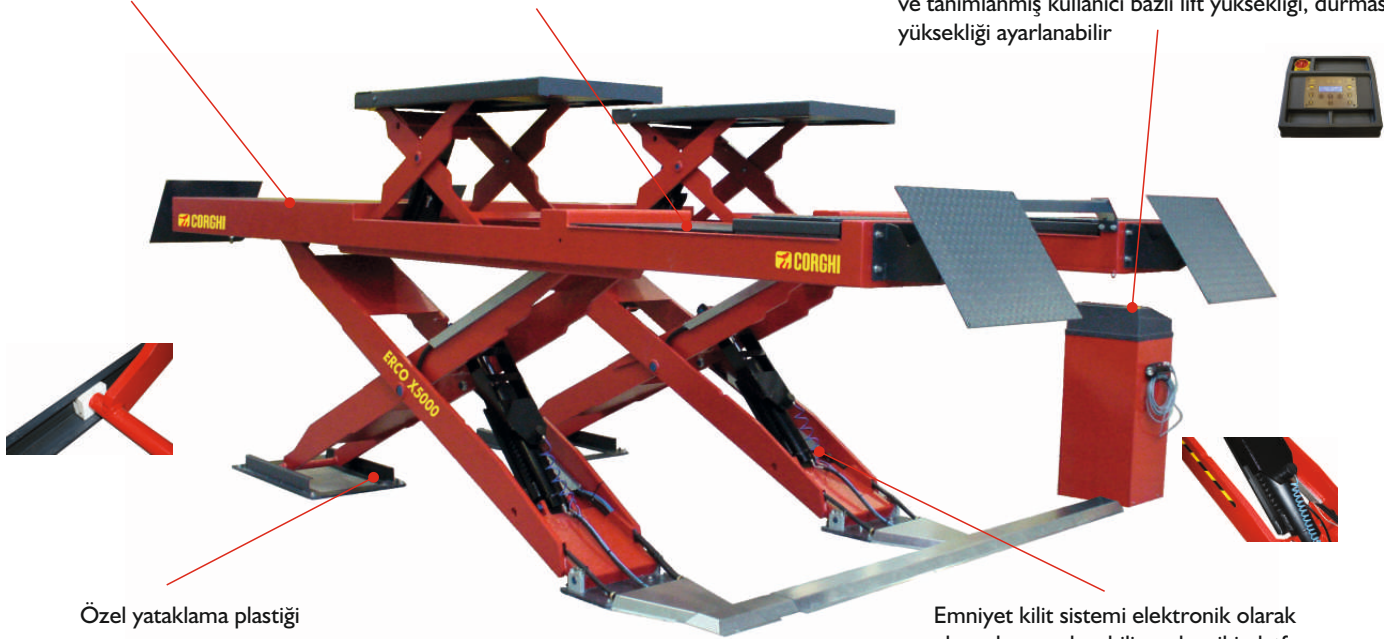

Özel yataklama plastięi

Emniyet kilit sistemi elektronik olarak ekrandan ayarlanabilir ve her iki platformun yüksekliğinin dengede olduğunu takibini yapar

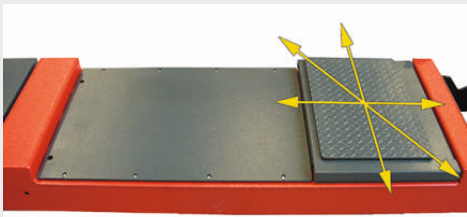

Opsiyonel Play Detector

(Ön düzen boşluk kontrol tablası)

• P2 ve P6 olarak iki modeli mevcuttur.

- P2 iki yönlü manuel kontrollü
- P6 altı yönlü kontrole olanak sağlayıp, kablosuz kumanda ile kontrol sağlamaktadır.



CORGHI ERCO HC4502 B / HC3502 B



İki Sütunlu Elektrohidrolik Lift

	ERCO HC4502 B	ERCO HC3502 B
Maksimum Yük Kapasitesi	4,5 Ton	3,5 Ton
Minimum Yükseklik	95 mm	95 mm
Maksimum Lift Yüksekliği	2864 mm	2864 mm
Maksimum Lift Kaldırma Yüksekliği	1850 mm	1850 mm
İki Sütun arası İç Genişlik	2800 mm	2800 mm
İki Sütun Dış Genişlik	3170 mm	3170 mm
İki Sütun Dış Taban Genişliği	3521 mm	3521 mm

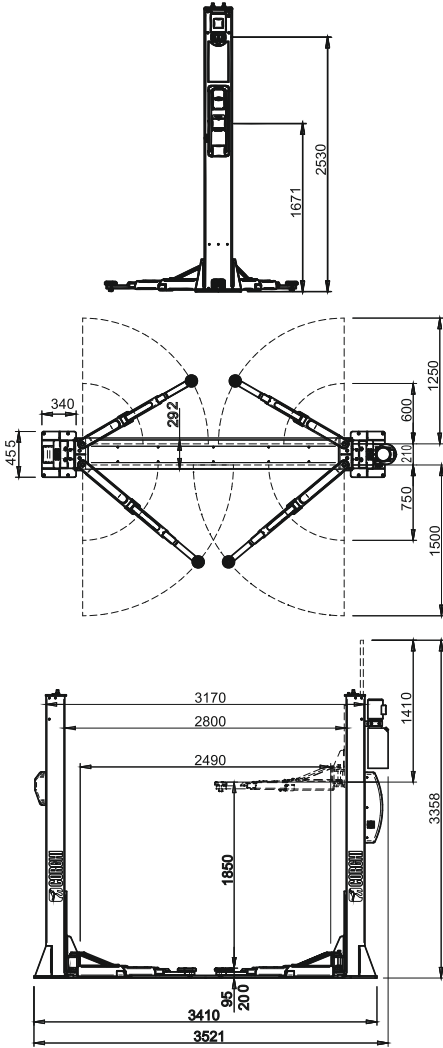

- Ekstra güçlendirilmiş kol bağlantı noktaları
- Konik şekillendirilmiş dişli sistemi ile asimetrik kolların daha kolay ve güvenilir kilitlemesini sağlar



- Asimetrik hareketli kaldırma kolları, teleskobik üç parçalı olarak maksimum uzunluk/kısalık sağlar



CORGHI ERCO HC6502 / HC5502 / HC4502

İki Sütunlu Elektrohidrolik Lift

	ERCO HC6502	ERCO HC5502	ERCO HC4502
Maksimum Yük Kapasitesi	6,5 Ton	5,5 Ton	4,5 Ton
Minimum Yükseklik	95 mm	95 mm	95 mm
Maksimum Lift Yüksekliği	3870 mm	4470 mm	5070 mm
Maksimum Lift Kaldırma Yüksekliği	2050 mm	2050 mm	2050 mm
İki Sütun arası İç Genişlik	3100 mm	3100 mm	3100 mm
İki Sütun Dış Genişlik	3785 mm	3785 mm	3785 mm

- Hidrolik devre sistemi (master / slave) sayesinde her kullanımda kaldırma kolları arasında otomatik olarak aynı konuma alarak bakım gerektirmeyen uzun ömürlü ve güvenli kullanım sağlar.
- Otomatik seviye ayarlı (kollar arası otomatik yükseklik kontrolü).

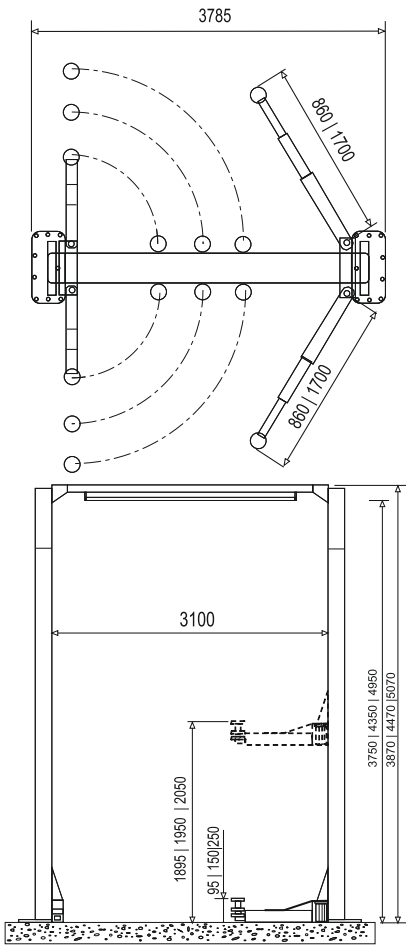

- Üç farklı yüksekliğe (95 / 150 / 250 mm) sahip kaldırma takozları ile bütün hafif ticari araçlara uyumlu



- Simetrik hareketli kaldırma kolları, teleskobik dört parçalı olarak maksimum uzunluk/kısalık sağlar



CORGHI ERCO C640 EF / C636 EF / C632 EF

	ERCO C640 EF	ERCO C636 EF	ERCO C632 EF
Maksimum Yk Kapasitesi	4 Ton	3,6 Ton	3,2 Ton
Minimum Yseklik	105 mm	110 mm	110 mm
Maksimum Lift Yseklięi	1970 mm	1970 mm	1970 mm
Maksimum Platform Uzunluęu	2120 mm	2120 mm	2120 mm

- Elektrohidrolik makaslı lift
- Hidrolik devre sistemi (master / slave) sayesinde her kullanımda kaldırma kolları arasında otomatik olarak aynı konuma alarak bakım gerektirmeyen uzun mrl ve gvenli kullanım saęlar.



CORGHI ERCO C40IT E / C36IT E

	ERCO C40IT E	ERCO C36IT E
Maksimum Yk Kapasitesi	4 Ton	3,6 Ton
Minimum Yseklik	290 mm	270 mm
Maksimum Lift Yseklięi	2020 mm	2020 mm
Maksimum Platform Uzunluęu	1535-2085 mm	1532-2085 mm

- Elektrohidrolik makaslı lift
- Zemine gmlen zel kasa tasarımı
- Hidrolik devre sistemi (master / slave) sayesinde her kullanımda kaldırma kolları arasında otomatik olarak aynı konuma alarak bakım gerektirmeyen uzun mrl ve gvenli kullanım saęlar.



CORGHI ERCO C510 B / C515 B

	ERCO C510 B B	ERCO C515 B
Maksimum Yk Kapasitesi	3,2 Ton	3,6 Ton
Minimum Yseklik	120 mm	120 mm
Maksimum Lift Yseklięi	1000 mm	1000 mm
Maksimum Platform Uzunluęu	1420-2040 mm	1420-2040 mm

- Elektrohidrolik makaslı lift
- Zemin st ve zemine gmlen zel kasa tasarımı
- Hidrolik devre sistemi (master / slave) sayesinde her kullanımda kaldırma kolları arasında otomatik olarak aynı konuma alarak bakım gerektirmeyen uzun mrl ve gvenli kullanım saęlar.



CORGHI BL 300 / 600

	BL 300	BL 600
Maksimum Yk Kapasitesi	300 kg	600 kg
Minimum Yseklik	150 mm	155 mm
Maksimum Lift Yseklięi	1000 mm	1200 mm
Maksimum Platform Uzunluęu	2000 mm	2160 mm

- Makaslı motosiklet lifti
- BL 300 hidropnmatik
- BL 600 elektrohidrolik





CORGHI BT 100E/3

- TÜV TÜRK araç muayene istasyonları ile uyumlu
- Binek araç ve hafif ticari araçlar için
- Hızlı, güvenilir veri ölçümü ve raporlama
- Genişletilebilir ekipman ve farklı özellikler, fren test, süspansiyon ve amortisör test, yanal kayma test sistemleri
- Tam otomatik uzaktan kumandalı
- Kanal yada rampa sistemine uygun
- Frenleme kuvvetini anlık gösterir
- Test sırasında tekerlek yanal kayma değerini gösterme
- Fren test standı 3500kg ağırlığa kadar olan SUV, binek ve hafif ticari araçlar için
- ABS ve sürekli 4 çeker araçlara tam uyumlu
- 2x4,8kW 6000N gücünde çift motor
- Otomatik silindir frenleme
- Epoksi silikon kaplı silindirler
- Güvenilir, uzun ömürlü ve yüksek çalışma gücü
- Farklı konumlandırılmış silindirler sayesinde daha yüksek optimizasyonlu fren testi
- Özel tasarlanmış yüksek kaliteli ve güvenilir şasi sayesinde ölçüm hassasiyeti



CORGHI BT 90 PRO

- TÜV TÜRK araç muayene istasyonları ile uyumlu
- Binek araç ve hafif ticari araçlar için
- Hızlı, güvenilir veri ölçümü ve raporlama
- Genişletilebilir ekipman ve farklı özellikler, fren test, süspansiyon ve amortisör test, yanal kayma test sistemleri
- Tam otomatik uzaktan kumandalı
- Kanal yada rampa sistemine uygun
- Frenleme kuvvetini anlık gösterir
- Test sırasında tekerlek yanal kayma değerini gösterme
- Fren test standı 3500kg ağırlığa kadar olan SUV, binek ve hafif ticari araçlar için
- ABS ve sürekli 4 çeker araçlara tam uyumlu
- 3kW 8000N gücünde motor
- Otomatik silindir frenleme
- Epoksi silikon kaplı silindirler
- Güvenilir, uzun ömürlü ve yüksek çalışma gücü
- Farklı konumlandırılmış silindirler sayesinde daha yüksek optimizasyonlu fren testi
- Özel tasarlanmış yüksek kaliteli ve güvenilir şasi sayesinde ölçüm hassasiyeti



CORGHI PT400-IC

- Binek araçlar için ön takım kontrolü
- 6 yönlü
- 3 ton

Bu ürün, bu markalar tarafından akredite edilmiştir.



CORGHI T-PT411

- Kamyon ve otobüsler için ön takım kontrolü
- 6 yönlü
- 16 ton



CORGHI T-BT 115-2S / T-BT 11E

- KAMYON VE OTOBÜSLER İÇİN
- TÜV TÜRK araç muayene istasyonları ile uyumlu
- Fren test standı 20000kg ağırlığa kadar olan ABS ve 4 çeker araçlara uyumlu
- 2x11kW 40000N gücünde çift motor • Pc monitör ve uzaktan kumandalı
- Rollerler: l= 1070mmxçap 250mm • Tek operatör kullanımına uygun
- Hızlı, güvenilir veri ölçümü ve raporlama
- Genişletilebilir ekipman ve farklı özellikler, fren test, süspansiyon ve amortisör test, yanıl kayma test sistemleri
- Tam otomatik uzaktan kumandalı • Kanal yada rampa sistemine uygun
- Frenleme kuvvetini anlık ve hızlı gösterme • Otomatik silindir frenleme
- Epoksi silikon kaplı silindirler • Güvenilir, uzun ömürlü ve yüksek çalışma gücü
- Farklı konumlandırılmış silindirler sayesinde daha yüksek optimizasyonlu fren testi
- Özel tasarlanmış yüksek kaliteli ve güvenilir şasi sayesinde ölçüm hassasiyeti



CORGHI SS3 11 SIDE TEST

- Yanıl kayma platformu(806249243)
- Dinamik sapma verilerini hızlı raporlama

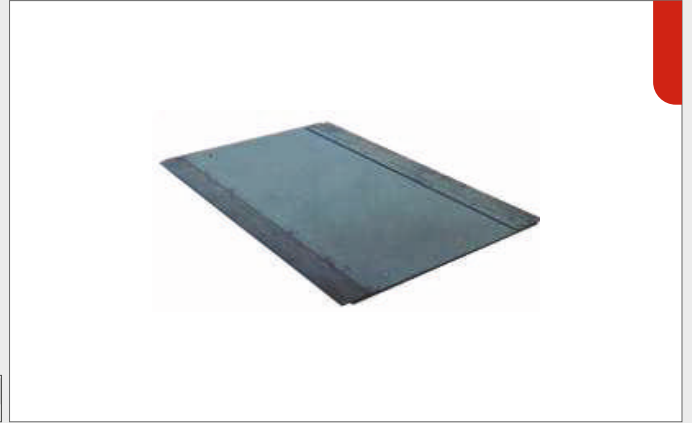

CORGHI BRAKE DINAMOMETER

- Fren testi için, fren pedalı uygulama gücü(806468073)
- Her test tekrarında aynı oranda fren gücü tatbik edilmesi sayesinde stabil veri raporlama



CORGHI ST200 NX

- Süspansiyon test kiti (8-61100042)
- Bağımsız tüm aksların ayrı olarak süspansiyon testlerini ölçer ve raporlar





CORGHI GAS 810 / 830

- Benzinli araçlar için gas analizi
- Benzin, metan ve lpg analizi
- CO, CO2, HC, O2 ve NOX gazları



CORGHI OPA 820

- Dizel araçlar için opasimetre
- Bilgisayara kablolu yada bluetooth ile bağlanabilir
- 16 tuşlu çok işlevli klavye
- Beyaz LED arkadan aydınlatmalı LCD
- 24 sütunlu lazer yazıcı



CORGHI OPA 840

- DİZEL araçlar için egzoz gaz analizi



CORGHI HT 970

- Far ayar cihazı
- Lazerli



CORGHI WED 850

- Lastik yıkama

CORGI PLATFORM RAMPASI

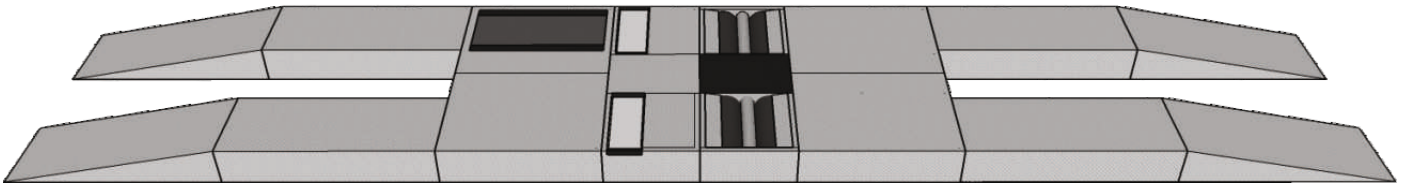
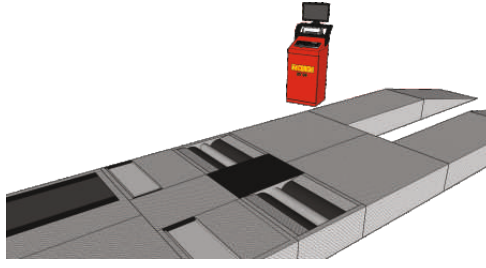
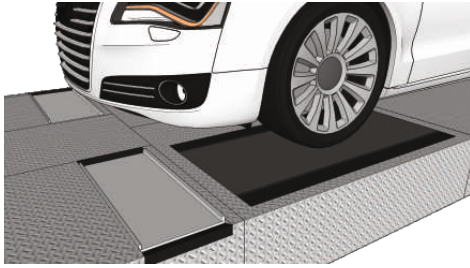
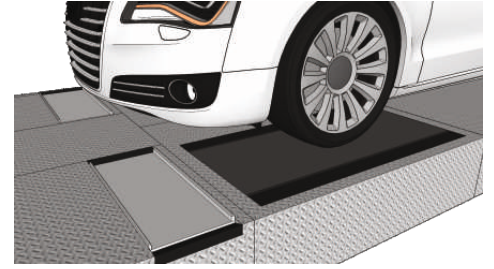
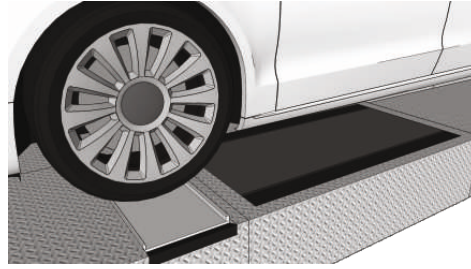
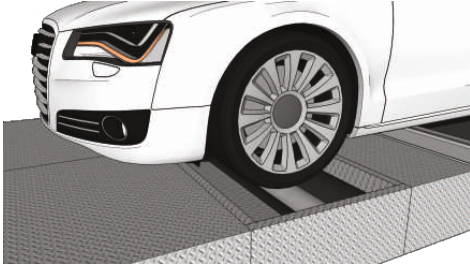
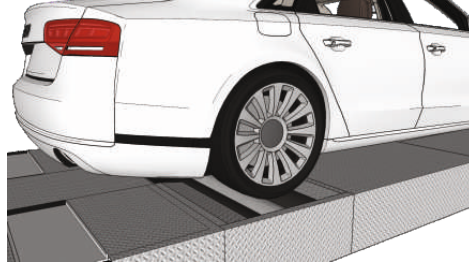
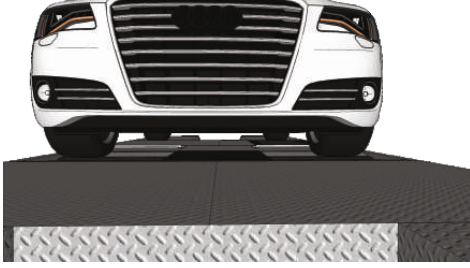



CORGHI A/C 930 L

- İklimlendirme Gaz Cinsi R134 A, • Vakum Pompası 100 lt/min
- Tank Kapasitesi 10 kg, • Filtre Kapasitesi 55kg, • Yağ Deposu 2x180 ml
- Gaz Terazisi 5 gr, • Yağ Terazisi 5 gr, • Çalışma Sıcaklık Aralığı 5-50 °C
- Kompresör 6,45 cc, • Hortumlar 3m - SAE-J2196, • E.bağlantısı 220V- 50-60 Hz
- FHS fonksiyonu klima sistemindeki yağın mükemmel şekilde temizlenmesi için geliştirilmiştir. • Gazın geri kazanımı cihaz içinde yada ayrıca bağlanabilen harici tanklarda depolanabilir. • Cihaz en küçük kaçaqlar için mikrotestler gerçekleştirebilir ve istenirse bunu PC üzerinden raporlayabilir. • SAE J2670 mikro kaçak onarım kiti opsiyoneldir. • Dahili yazıcı opsiyoneldir. • Flashing özelliği ile klima sistemi komple boşaltılıp temizlenebilir. • Otomatik olarak klima sistemi içerisindeki gazlar tekrar geri kullanılır. • Kaçak tespitinde sesli olarak uyarı ikazı verir. • Dahili güncellenebilir araç databankı. • Dahili terazileri ile klima sistemine kullanılan gaz ve yağ miktarını ölçme. • Entegre edilmiş otomatik ısı sensörlü gaz tankı



CORGHI A/C 934 L

- İklimlendirme Gaz Cinsi R1234yf, • Vakum Pompası 100 lt/min
- Tank Kapasitesi 10 kg, • Filtre Kapasitesi 55kg, • Yağ Deposu 2x180 ml
- Gaz Terazisi 5 gr, • Yağ Terazisi 5 gr, • Çalışma Sıcaklık Aralığı 5-50 °C
- Kompresör 6,45 cc, • Hortumlar 3m - SAE-J2196, • E.bağlantısı 220V- 50-60 Hz
- FHS fonksiyonu klima sistemindeki yağın mükemmel şekilde temizlenmesi için geliştirilmiştir. • Gazın geri kazanımı cihaz içinde yada ayrıca bağlanabilen harici tanklarda depolanabilir. • Cihaz en küçük kaçaqlar için mikrotestler gerçekleştirebilir ve istenirse bunu PC üzerinden raporlayabilir. • SAE J2670 mikro kaçak onarım kiti opsiyoneldir. • Dahili yazıcı opsiyoneldir. • Flashing özelliği ile klima sistemi komple boşaltılıp temizlenebilir. • Otomatik olarak klima sistemi içerisindeki gazlar tekrar geri kullanılır. • Kaçak tespitinde sesli olarak uyarı ikazı verir. • Dahili güncellenebilir araç databankı, • Dahili terazileri ile klima sistemine kullanılan gaz ve yağ miktarını ölçme. • Entegre edilmiş otomatik ısı sensörlü gaz tankı



CORGHI A/C 988

- İklimlendirme Gaz Cinsi R134 A, • Vakum Pompası 100 lt/min
- Tank Kapasitesi 10 kg, • Filtre Kapasitesi 55kg, • Yağ Deposu 2x180 ml
- Gaz Terazisi 5 gr, • Yağ Terazisi 5 gr, • Çalışma Sıcaklık Aralığı 5-50 °C
- Kompresör 6,45 cc, • Hortumlar 3m - SAE-J2196, • E.bağlantısı 220V- 50-60 Hz
- FHS fonksiyonu klima sistemindeki yağın mükemmel şekilde temizlenmesi için geliştirilmiştir. • Gazın geri kazanımı cihaz içinde yada ayrıca bağlanabilen harici tanklarda depolanabilir. • Cihaz en küçük kaçaqlar için mikrotestler gerçekleştirebilir ve istenirse bunu PC üzerinden raporlayabilir. • SAE J2670 mikro kaçak onarım kiti opsiyoneldir. • Dahili yazıcı opsiyoneldir. • Flashing özelliği ile klima sistemi komple boşaltılıp temizlenebilir. • Otomatik olarak klima sistemi içerisindeki gazlar tekrar geri kullanılır. • Kaçak tespitinde sesli olarak uyarı ikazı verir. • Dahili güncellenebilir araç databankı. • Dahili terazileri ile klima sistemine kullanılan gaz ve yağ miktarını ölçme. • Entegre edilmiş otomatik ısı sensörlü gaz tankı



CORGHI A/C 989

- İklimlendirme Gaz Cinsi R1234yf, • Vakum Pompası 100 lt/min
- Tank Kapasitesi 10 kg, • Filtre Kapasitesi 55kg, • Yağ Deposu 2x180 ml
- Gaz Terazisi 5 gr, • Yağ Terazisi 5 gr, • Çalışma Sıcaklık Aralığı 5-50 °C
- Kompresör 6,45 cc, • Hortumlar 3m - SAE-J2196, • E.bağlantısı 220V- 50-60 Hz
- FHS fonksiyonu klima sistemindeki yağın mükemmel şekilde temizlenmesi için geliştirilmiştir. • Gazın geri kazanımı cihaz içinde yada ayrıca bağlanabilen harici tanklarda depolanabilir. • Cihaz en küçük kaçaqlar için mikrotestler gerçekleştirebilir ve istenirse bunu PC üzerinden raporlayabilir. • SAE J2670 mikro kaçak onarım kiti opsiyoneldir. • Dahili yazıcı opsiyoneldir. • Flashing özelliği ile klima sistemi komple boşaltılıp temizlenebilir. • Otomatik olarak klima sistemi içerisindeki gazlar tekrar geri kullanılır. • Kaçak tespitinde sesli olarak uyarı ikazı verir. • Dahili güncellenebilir araç databankı, • Dahili terazileri ile klima sistemine kullanılan gaz ve yağ miktarını ölçme. • Entegre edilmiş otomatik ısı sensörlü gaz tankı

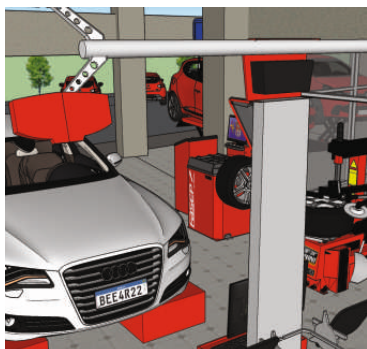
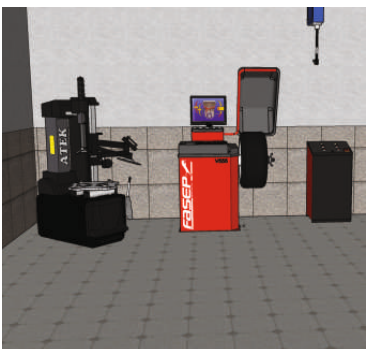
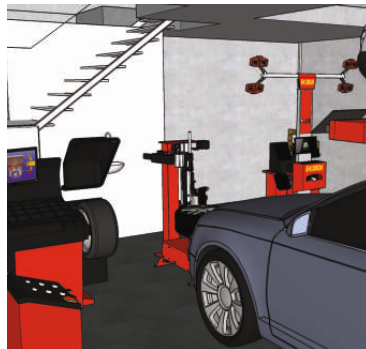
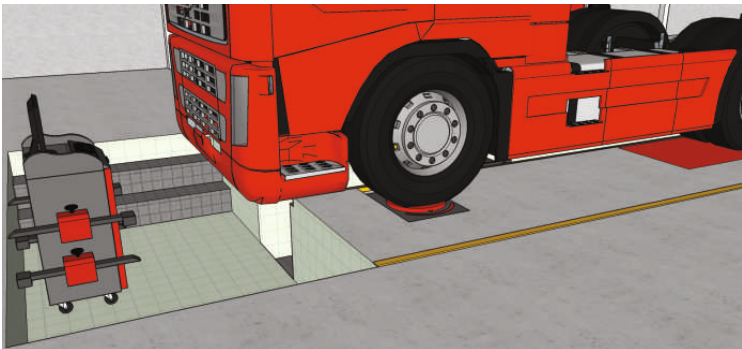

“get ready for change”
“değişime hazır olun”

Showroom: Atatürk mah.
Hadımköy yolu üzeri 2.km
no.14 Esenyurt İstanbul Turkey
Tel. 0090 444 21 31
email. atek@atekmakina.com

Factory: Hastane mah.
Hadımköy İstanbul cad. no.54 34555
Arnavutköy İstanbul Turkey
Tel. 0090 0212 771 34 69 (pbx)

АТЕК МАШИНА ул. владая номер 1А
Пловдив / България до. Mr. Bricolage
Тел. 032/ 620 290; 032 629 782-83-84-85-86
Tel TR. 0212 944 44 34
Gsm. 00887227180 факс: 032/ 626 530
email. atek@atekmashina.bg web. www.atekmashina.bg

www.atekmakina.com