



Vector Measuring System

Users Manual

Table Of Contents

I.	INTRODUCTION	1
	VECTOR LIMITED WARRANTY AGREEMENT	
	GENERAL OVERVIEW	1
	About This Manual	1
	Training	1
	VARIANCES: GRAPHICS / SPECIFICATIONS	2
	Specifications Versus Vehicle Measurements	2
	GENERAL SAFETY INFORMATION	3
	Controls	3
	Laser Safety Information	3
	Federal Communications Commission	4
	COPYRIGHT INFORMATION	4
	Vector Users Manual	4
	Vector Software	4
	VECTOR ASSISTANCE	5
II.	VECTOR HARDWARE	6
	COMPONENT TERMINOLOGY	6
	COMPONENT OVERVIEWS	7
	Workstation	7
	Body Scanner and Tray	8
	Targets	9
	Target Base	10
	Attachments / Clips	10
	Bolt Attachments	11
	Hole Attachments	11
	Optional Attachments	12
	Optional Magnetic Attachments	12
	Optional Target Extension Rods	13
	Optional Truck Attachment Package	13
	Optional Upper Body Bar Assembly	14
	Spacers and 3 Inch Bolts	16
	Chief Specifications Data	16
	Literature	16
	Diskettes and CDs	17
	COMPONENT MAINTENANCE	18
	COMPONENT TROUBLESHOOTING	20
III.	VECTOR PROGRAM	21
	STARTING UP VECTOR SYSTEM	21
	VECTOR TITLE SCREEN - OPENING WINDOW	22
	VECTOR WINDOWS AND MENUS	23
	SHUTTING DOWN VECTOR SYSTEM	23
	WINDOWS	24
	DIALOG BOXES	26
	VEHICLE GRAPHICS	28
	KEYBOARD, AND MOUSE	30
	SPECIAL KEYS	33
	HELP TEXT	34
	HOW TO USE HELP	36
	VECTOR TUTORIAL	39
	VECTOR WIZARD	39



VECTOR MEASURING SYSTEM LIMITED WARRANTY AGREEMENT

Chief Automotive Technologies, Inc. warrants for one year from date of purchase any components of its Vector Measuring System and 18 months for its Laser Lock Scanner which do not perform satisfactorily due to defect caused by faulty material or workmanship. THE WARRANTY DESCRIBED HEREIN SHALL BE IN LIEU OF ANY OTHER WARRANTY, EXPRESS OR IMPLIED, INCLUDING BUT NOT LIMITED TO, ANY IMPLIED WARRANTY OF MERCHANTABILITY, OF FITNESS FOR A PARTICULAR PURPOSE, OF TITLE, OR OTHERWISE ON THE PART OF CHIEF AUTOMOTIVE TECHNOLOGIES, THE EQUIPMENT, THE SPECIFICATIONS CONTAINED THEREIN OR ANY UNIT THEREOF. Chief's obligation under this warranty is limited to the repair or replacement of components which are defective and which have not been misused, carelessly handled, or defaced by the repair or repairs made or attempted by others. Chief Automotive Technologies does not assume responsibility for any injury or property damage resulting from the operator's misuse of this product. Unless a statement made by any representative of Chief Automotive Technologies is identified as a warranty, any such statements shall not be construed to constitute warranties and do not form part of the basis of the bargain; it being expressly understood that such statements are merely made in the course of the negotiations of the parties. FURTHERMORE, Chief Automotive Technologies specifically excludes or disclaims any warranty, express or implied, based on any sample or model shown by Chief Automotive Technologies to the buyer for demonstration purposes only.

LIMITATION OF REMEDIES. The parties agree that the buyer's sole and exclusive remedy against Chief Automotive Technologies shall be for the repair or replacement of components which are defective and which have not been misused, carelessly handled, or defaced by the repair or repairs made or attempted by others. The buyer agrees that no other remedy (including, but not limited to, incidental or consequential damages for lost profits, lost sales, injury to person or property, or any other incidental or consequential loss) shall be available to him. This exclusive remedy shall not be deemed as to have failed of its essential purpose so long as Chief Automotive Technologies is willing and able to repair or replace defective parts in the pre-scribed manner.

Prior to the return of any merchandise for a warranty claim, contact the Customer Service Department (800-445-9262) for a Returned Goods Authorization Number and instructions. No goods may be returned without a Returned Goods Authorization Number.

The buyer shall be required to deliver the defective part to Chief Automotive Technologies UNLESS (1) the part was destroyed as a result of its defect or of any defect in any part covered in this warranty, AND (2) Chief is reasonably satisfied that the part was defective at the time of its failure.

DISCLAIMER OF WARRANTY

THE GRAPHICS AND DATA SUPPLIED WITH THE VECTOR MEASURING SYSTEM HAVE BEEN COMPILED FROM AUTHORITATIVE SOURCES. EVERY EFFORT HAS BEEN MADE BY CHIEF AUTOMOTIVE TECHNOLOGIES, TO ASSURE ACCURACY; HOWEVER, MANUFACTURING CHANGES, ERRORS OR OMISSIONS MIGHT OCCUR. CHIEF AUTOMOTIVE TECHNOLOGIES DOES NOT ASSUME RESPONSIBILITY NOR CAN IT BE HELD RESPONSIBLE FOR THE LOSS OR DAMAGE RESULTING FROM VEHICLE MANUFACTURER'S CHANGES, ERRORS, OR OMISSIONS IN THIS SYSTEM.

VECTOR MEASURING SYSTEM WARRANTY REGISTRATION FORM

Please fill out completely and detach from Vector Measuring System Users Manual. Return form to:
Chief Automotive Technologies, 996 Industrial Drive Madison, Indiana 47250

Accepted this	day of	20
Serial Numbers:		
System	Shop Name:	
Body Scanner	Address:	
Computer	City, State, Zip:	
Monitor	By:	
Printer	Title:	

I. INTRODUCTION

GENERAL OVERVIEW

Whether detecting misalignment in a vehicle's structure or verifying repairs have eliminated the damage, the Vector computerized measuring system can do the job. Vector integrates the precision of laser scanning with a computerized data base for unmatched accuracy in collision repair and analysis. In addition to showing extent of collision damage, Vector monitors progress throughout the repair and verifies the vehicle's structure is correctly aligned. Printed reports verify the vehicle's structural condition by showing overhead diagrams that display centerline, datum line and datum height measurements.

The Vector system measures on the principle of triangulation. The system's electronic Body Scanner houses Laser Lights that reflect off of revolving mirrors toward light-reflective Targets (each bearing a unique code) that are suspended from a vehicle's reference points. The Body Scanner houses photo sensors that identify the angle of revolving laser reflections. This information is transferred to the computer which performs the triangulation and Target identification functions.

About This Manual

This manual provides information on basic hardware components. It also provides pertinent information regarding startup/shutdown procedures, examples of on-screen Windows/Dialog Boxes and Vehicle Graphics, Keyboard/Mouse/Pen functions, Special Keys, and information on how to use the Vector Help Text. Pertinent software functions and parts ordering information appear in the Tutorial and the Vector Parts Manual.

Chief Automotive Technologies reserves the right to alter product specifications and/or package components without notice. Also, components shown in this manual may vary slightly in appearance from those that are actually supplied with the Vector computerized measuring system.

Training

Chief Automotive Technologies also offers professional training. For maximum productivity and equipment utilization, each person operating a Vector computerized measuring system should receive training conducted by Chief Training Department personnel. For information about training locations and dates, contact Chief Automotive Technologies, 996 Industrial Drive Madison, Indiana 47250 tel. 800-445-9262 Option 2, Attn: Training Department School Coordinator or contact your local representative.

VARIANCES: GRAPHICS/ SPECIFICATIONS

Graphics

The Graphics displayed by the Vector computerized measuring system are of high quality and have been checked for accuracy, but may not reflect the vehicle's actual appearance in every detail. Variances may exist as a result of changes made by vehicle manufacturers or details omitted as a result of space limitations.

Specifications Versus Vehicle Measurements

A vehicle's final measurements may vary from specifications listed and still be aligned correctly. Variances between vehicle measurements and specifications result from one or a combination of the following conditions:

- Vehicle specifications are compiled from vehicle manufacturer's engineering drawings and/or the measuring of new (undamaged) vehicles.
- Most vehicle manufacturers control only a small number of reference points on vehicle's lower structure. These reference points are commonly referred to as master control points, class one control points, principle locating points, etc. Each of these control points is usually held to a tolerance of plus or minus 3mm in three dimensions (length, width, height). Other reference points have a larger tolerance, but generally, a tolerance of plus or minus 5mm in three dimensions (length, width, height) is considered 'normal' according to Chief Automotive Technolog-

ies experience. In Arrow Display Mode, reference point measurements that exceed tolerance appear in 'red' whereas those falling within tolerance appear in 'blue'.

- Some reference points used for dimensioning the same make and model of vehicle vary from one manufacturing plant to another. Also, periodic manufacturing improvements can affect the location of points used for dimensioning.

Key points to remember when realigning a vehicle:

- Length and width dimensions on each side of vehicle should be within plus or minus 3mm of each other when control or reference points are symmetrical. Frequently, the height at front and rear of vehicle will exceed this tolerance according to Chief Automotive Technologies experience.
- When excessive pressure is needed near end of realignment process, and when area around spot welds begins to deform, stop pulling and re-evaluate the repair. This situation usually occurs when a vehicle's components were not placed on specification during manufacture. In this case, continuing to pull in an attempt to achieve an exact specification may actually damage the vehicle.
- When a vehicle's dimensions vary beyond 'normal' tolerances, it is the repair technician's responsibility to determine if dimensional variances will affect suspension and steering alignment, the safe operation and handling of vehicle and alignment of body panels.

GENERAL SAFETY INFORMATION

⚠ CAUTION: Use of controls or adjustments or performance of procedures other than those specified in this Users Manual may result in hazardous radiation exposure. See CAUTIONS on Workstation and Body Scanner. (See illustrations on this page.)

IMPORTANT: Make sure the Vector System is connected to a live power source. (Dependent upon model, power source might be 110-volt, 15 amp or 220-volt, 5 amp — voltage requirements may vary in some countries.) A single purpose line is recommended. Avoid circuits with power surges such as from welders and some power tools. The built-in surge protector may not be sufficient to protect against current fluctuations that may cause the computer to fail. Also avoid metal-to-metal contact between all components (i.e. Workstation, Body Scanner, Welder, Vehicle Platform).

Controls

“On”/“Off” switch on Workstation — Allows power to Computer and other electrical components.

On/off switch on Body Scanner — Allows power to Body Scanner including lasers.

Laser Safety Information

Laser Power Output:

2.5 mw @ 4.2×10^{-4} sec.

Wavelength:

650 - 670 n Meters

WORKSTATION

NOTE:

1. Properly licensed / certified electrician needed to install the appropriate power cord plug end on main Vector power cord set.
2. Vector System is for indoor use only.



- 1 - Workstation
- 2 - Power 'On' Indicator

⚠ CAUTION: LASER RADIATION - DO NOT STARE INTO BEAM - Class II Laser Product.

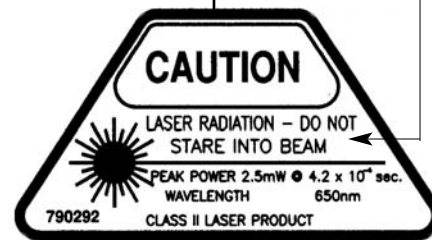

⚠ CAUTION: Avoid exposure! Laser radiation is emitted from these apertures.



- 1 Body Scanner
- 2 Lasers Emissions
- 3 Laser Reflections
- 4 Always turn scanner off before disconnect-

General Safety Information (continued)

Federal Communications Commission

The Vector computerized measuring system has been tested and found to comply with: 1) Limits for a Class A digital device, pursuant to Part 15 of the FCC Rules. 2) CE standards for emissions (EN55011) and Immunity (EN61326). These limits are designed to provide reasonable protection against harmful interference when equipment is operated in a commercial environment. This equipment generates, uses, and can radiate radio frequency energy and, if not installed and used in accordance with users and training manuals provided, may cause harmful interference to radio communications. Operation of this equipment in a residential area is likely to cause harmful interference in which case the user will be required to correct the interference at his own expense.

COPYRIGHT INFORMATION

Vector Users Manual

Vehicle Service Group © 2010. All Rights Reserved. No part of this work covered by copyrights hereon may be reproduced or copied in any form or by any means including,

but not limited to, graphics, electronic, or mechanical, including photocopying, taping, printing or information storage and retrieval systems — without written permission of Vehicle Service Group, Madison, Indiana, U.S.A. All inquiries relating to use of this information should be addressed to Chief Automotive Technologies, Tel 800-445-9262 Option 2, Fax 866-275-0173.

Vector Software

Vehicle Service Group © 2010. All Rights Reserved. No part of this work covered by copyrights hereon may be reproduced or copied in any form or by any means including, but not limited to, graphics, electronic, or mechanical, including photocopying, taping, printing or information storage and retrieval systems — without written permission of Chief Automotive Technologies, Madison, Indiana U.S.A. All inquiries relating to use of this information should be addressed to Chief Automotive Technologies, Tel 800-445-9262 Option 2, Fax 866-275-0173.

VECTOR ASSISTANCE

Chief Automotive Technologies offers assistance to Vector program operators. When contacting Chief Automotive Technologies, operators should be prepared to give their name, telephone number (including area code), version of software in use and nature of problem encountered. To identify version of software in use, select 'About' from list of items under Help heading in any Menu Bar. In U.S.A., call toll free 800-445-9262 Option 2. If outside U.S.A., contact an authorized Chief Automotive Technologies representative.

Computer Program Updates

Updates and changes to computer programs will be issued from time to time via computer CDs

Explanations of changes and instructions for installing them will accompany the CDs.

Specification Updates/Corrections

Annually, and as required, updates and additions to vehicle specifications (and instructions for installation) will be made available for purchase.

Keeping Records of Service and Updates

Owners should keep records of services performed and updates provided. These records will be helpful when placing calls to the toll free support number.

II. VECTOR HARDWARE

COMPONENT TERMINOLOGY

Equipment in Chief's Vector Computerized Measuring System (see Figure 1) is easy to use and provides accurate readings. Its basic components include:

- | | |
|------------------|-------------------------|
| 1 - Monitor | 5 - Tray |
| 2 - Keyboard | 6 - Targets |
| 3 - Workstation | 7 - Attachments / Clips |
| 4 - Body Scanner | |

⚠ CAUTION: Use of controls, adjustments or performance of procedures other than those specified in this manual may result in a breach of warranty and could result in hazardous radiation exposure. See CAUTIONS on Workstation and Body Scanner.



Figure 1

COMPONENT OVERVIEWS

Workstation

The Vector Workstation (see Figure 2) is a steel cabinet that houses a Computer, Display Monitor, Keyboard, Printer, Power Supply (+ 12 volt, 5 AMP), and assorted Targets, Attachments, Clips and Scales. The cabinet is supported by casters and features a tray for the Body Scanner when it is not in use.

Computer hardware provided with new Vector systems (see Figure 4) can run Windows XP. It also features a hard drive and 3.5 inch floppy diskette; 256 MB memory (minimum); 32 MB video ram; 1 serial port; 1 parallel port; mouse and keyboard devices (see Figures 2 and 3); a display monitor with super VGA color capabilities (see Figure 2); and, a printer (see Figure 4).

Connect the Vector to a 110-volt, 15 amp power source or 220-volt, 5 amp power source. (Check voltage requirements for Vector system being used.) A single purpose line is recommended. Do not use circuits subject to frequent interruptions or outages. Avoid circuits with power surges such as from welders and some power tools. Built-in surge protector may not be sufficient to protect against current fluctuations and it may cause the Vector computer to fail. Avoid metal-to-metal contact between components (i.e. Workstation, Body Scanner, Welder, Vehicle Platform), and move the Vector components away from welding areas to avoid damage from sparks.

IMPORTANT: Voltage requirements may vary in some countries.

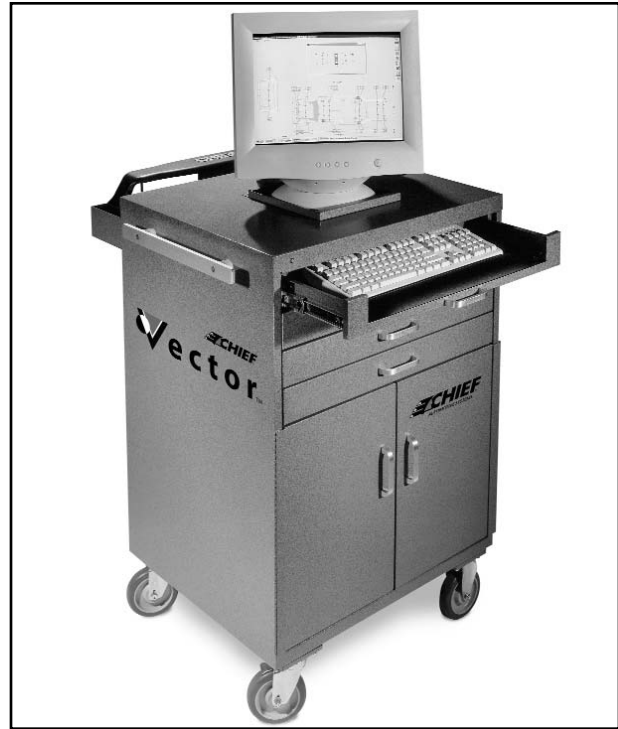

Figure 2



Figure 3



Figure 4

Position Workstation near work area and attach Body Scanner Cable. Attach Cable end **without** cylindrical RFI Ferritt Bead to Workstation. (See Figure 5.) Then attach Cable end **with** cylindrical RFI Ferritt Bead to Body Scanner. (See arrow - Figure 6.) Body Scanner ‘on/off’ switch is shown in Figure 7. (Inset photo for Figure 5 shows connections for a 220-volt, 5 amp Vector System.)

IMPORTANT: Computer and Body Scanner are precision electronic tools. Movement of components must be done with care. Do not move Workstation during a ‘continuous’ measurement or during program accessing.

Body Scanner and Tray

The Vector system measures on the principle of triangulation. The Body Scanner houses rotating Laser Lights that project toward light reflective Targets (each bearing a unique code) on vehicle’s structure. Body Scanner also houses photo sensors that identify the angle of revolving laser reflections. This information is transferred to computer which performs triangulation and Target identification functions. The Scanner’s parabolic design filters out sunlight allowing for greater productivity.

110 Volt System

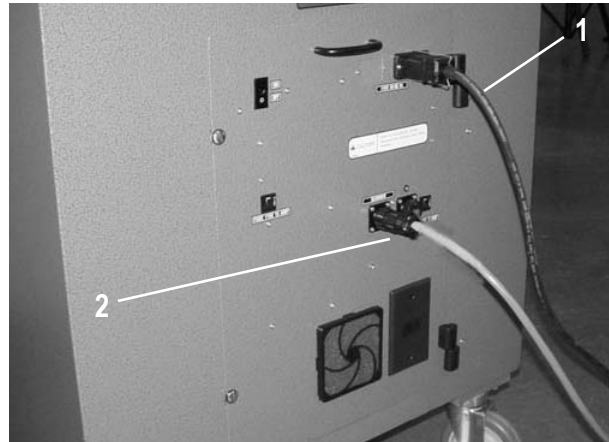

Figure 5

1 - Power Cable 2 - Body Scanner Cable

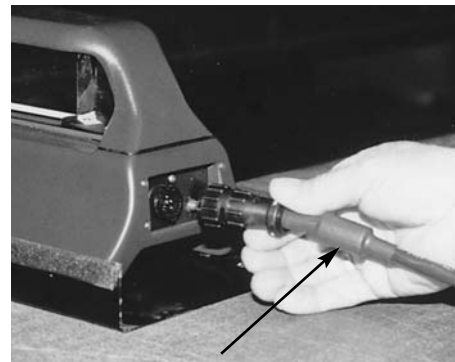

Figure 6



Figure 7

Body Scanner Tray is the base upon which to position Body Scanner. Rubber strips on the Tray's inside edges and insulating feet on the bottom of Body Scanner help prevent metal-to-metal contact between Tray and Body Scanner.

Insert Body Scanner Tray below vehicle's center section (see Figure 8) and place the Body Scanner on Tray (see Figure 9). Cable port must be under the left side of vehicle. This positioning allows the Body Scanner to be synchronized with computer program.

Body Scanner does not need to be square to the vehicle or level. Make sure, however, it remains in the Tray and the Tray is stable. It is permissible to reposition Tray any time or shift the Body Scanner in the Tray. Vector recalibrates any repositioning in its next measurement cycle.

Targets

All Targets are numbered and their reflective faces bear a unique code. (See Figure 10.) Most Targets are interchangeable, although some have specific uses. An assortment of clips, extensions and other attachment devices provide flexibility in Target placement. All specifications are provided from reference hole and bolt centers.

Targets 1 - 36 (and optional Targets 37-40) are interchangeable depending on length of pendant needed. Optional Targets 41 and 42 are used with a Target Base when measuring lower control arms. Optional Targets 43, 44, and 45 are used with the Optional Upper Body Bar when measuring strut tower and other upper body reference points.



Figure 8

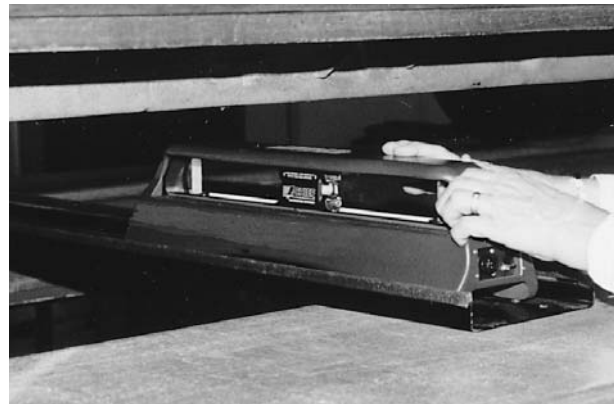

Figure 9

NOTE:

- 1) Although Targets numbered 1 - 36 (and optional Targets 37-40) are interchangeable, be consistent when placing them at reference points.
- 2) With the exception of optional Targets 41 - 45, Targets can be used on either side of the vehicle. Optional Targets 41 and 42, which are primarily used to measure ball joint locations, must be used on the left and right side of the vehicle respectively. Optional Targets 43 and 44, which are used to measure strut tower locations, must be installed on the Lower Bar of the Upper Body Bar Assembly directly below their respective Pointers. Optional Target 45 must be in the center of the Lower Bar.

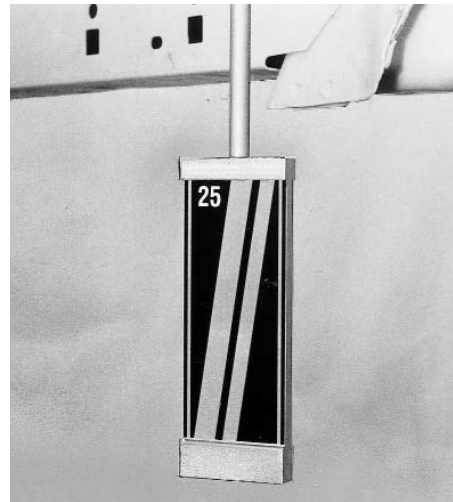
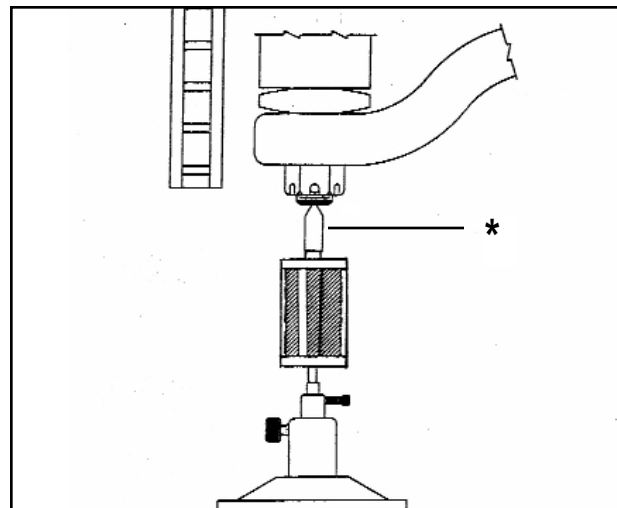

Figure 10

Target Base

Any Target except optional Targets 43, 44 and 45 can be used with the Target Base. (See Figure 11.) Target Base sits on platform and Target is projected upward from it to a reference point. When using Target Base to project a Target to a specific reference point, the Target Pendant requires the addition of a Cone Attachment (see Figure 11) to compensate for absence of an attachment or clip. Optional Targets 41 and 42 are used with the Target Base to make comparison measurements of ball joint locations.



* Cone Attachment

Figure 11

Attachments / Clips

A variety of Attachments, Clips and Extensions allow Targets to be mounted to practically any reference hole or bolt. These include Bolt Attachments, and Hole Attachments.

IMPORTANT: When using different attachments than what is suggested in the Point Information Dialog Box, input the correct information in the Change Attachment Dialog Box.

Bolt Attachments

Bolt attachments work equally well on the bottom of a structural component or on the side of a structural component. The nylon base of each attachment swivels to allow for easy Target adjustments.

Metal Clip Style 'Bolt Attachments' have a strong gripping capability and are designed to fit a wide range of bolts (and nuts) used on a vehicle's structure. The small size grasps bolts/nuts with a 10 to 20mm diameter. The medium size grasps bolts/nuts with a 15 to 25mm diameter, and the large size grasps bolts/nuts with a 25 to 35mm diameter. (Figure 12 and its inset show an example of a nylon base bolt attachment.)

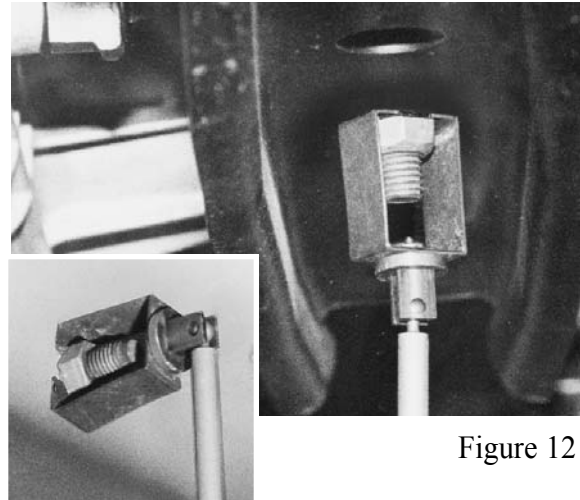

Figure 12

Hole Attachments

Hole Attachments snap into all types of reference holes. Most work equally well on the bottom or side of structural components. The attachments feature a nylon base or a mounting clip that allows for easy Target adjustments.

IMPORTANT: When using Hole Attachments in elongated (oval) reference holes, refer to Point Information Dialog Box for correct positioning.

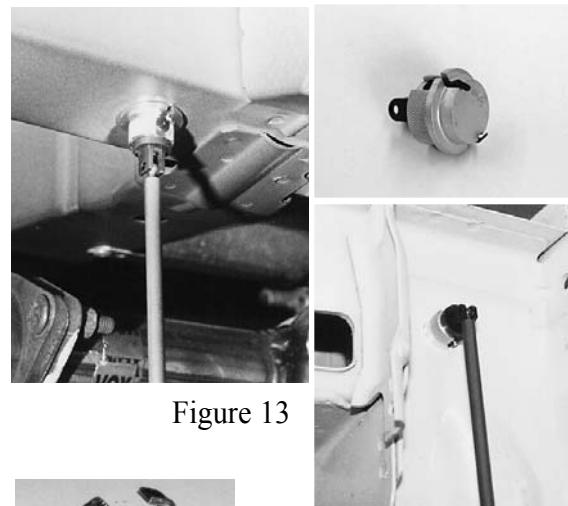

Figure 13

Aluminum Snap In Attachments - snap into all types of reference holes. They are made of aluminum and are provided in varying sizes ranging from 10 to 32mm in diameter. (Figure 13 and its insets show an example of an aluminum snap-in attachment.)



Figure 14

Bottom Hole Clips - are small metal clips that allow Targets to be mounted to horizontal reference holes measuring 5 to 10mm in diameter. (See Figure 14.)

Extruded Hole Attachments - mate with both horizontal and vertical reference holes. Spring tension holds the attachment within the hole so that Targets can be mounted as shown in Figure 15 and its inset.

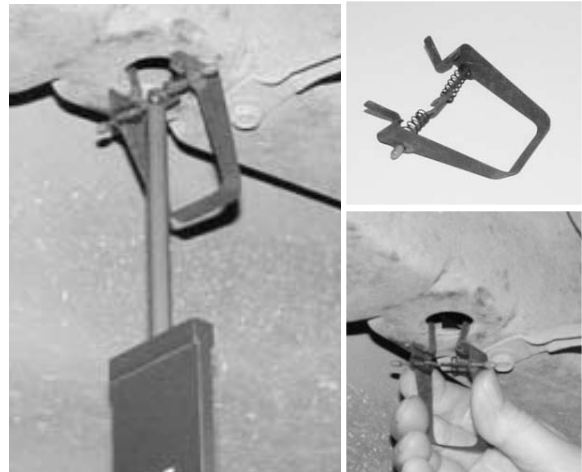

Figure 15

Side Hole And Extended Side Hole Clips - are used to mount Targets to vertical reference holes. The looped portion of the attachment hooks inside the reference hole providing the support needed for mounting Targets. (See Figure 16 and its inset.) Extended length side hole clips are provided to help technicians work around obstructions.

Optional Attachments

IMPORTANT: When using different attachments than what is suggested in the Point Information Dialog Box, input the correct information in the Change Attachment Dialog Box.

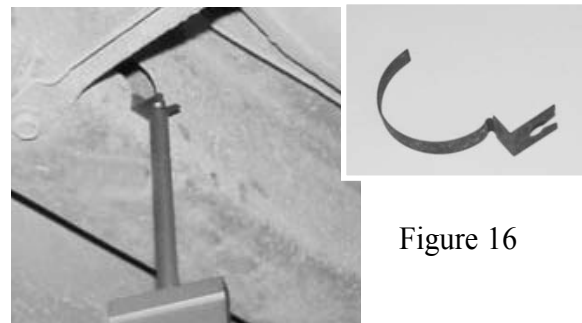

Figure 16

Optional Magnetic Attachments

Magnetic Attachments (optional) (see Figures 17 and 18) are used on bottom of structural members when reference holes or other mounting locations are not accessible. This attachment, used primarily for comparative measurements, should be positioned so that its vertical surface is flush with vertical surface of structural member it mounts to. The Target can then be mounted in attachment's clip.

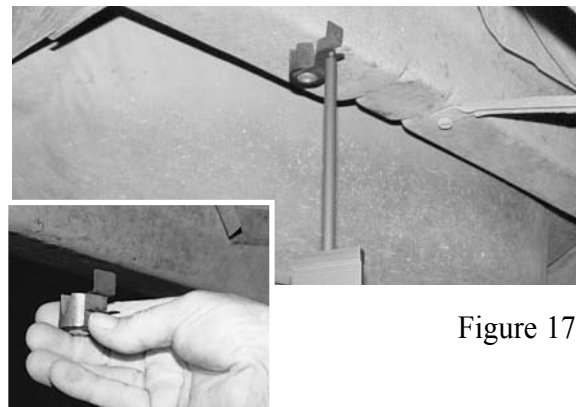

Figure 17

The magnet on the attachment is strong and will maintain its holding power if cared for properly. A Magnet Keeper (see Figure 18 inset) should be positioned on magnet when the attachment is not in use.

IMPORTANT: Never use arc welder or heat near Magnetic Attachment as this tends to reduce its holding power.



Figure 18

Optional Target Extension Rods

Target Extensions (optional) - are available in lengths of 156mm and 256mm. (See Figure 19.) A third extension is C-shaped for reaching around obstructions. The Extensions allow greater flexibility when extra length is needed and when mounting Targets in locations where obstructions prevent normal installation. (See Figures 20 and 21 and Figure 20 inset.)

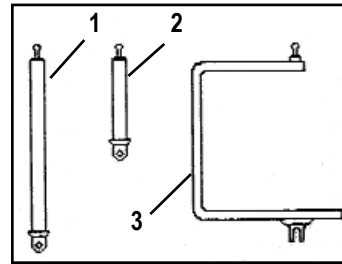

1 - 256mm (red)
2 - 156mm (blue)
3 - C-Shaped Extension

Figure 19



Figure 20

Optional Truck Attachment Package

The Truck Attachment Package (optional) is occasionally referred to as “Drawer 4”. It consists of Magnetic Bolt Head Attachments, Threaded Attachments and extra long Targets. The components of the package allow the operator to measure the end sections of high ground clearance vehicles.



Figure 21

Magnetic Bolt Head Attachments (optional)- have a strong gripping capability and are designed to fit a wide range of bolt heads. (Figure 22 and its inset show an example of a magnetic bolt head attachment.)

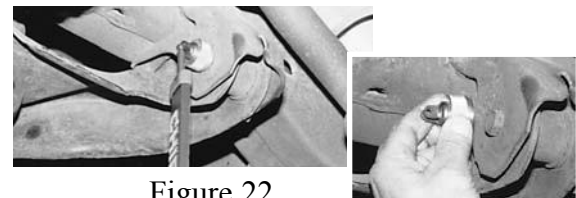

Figure 22

Threaded Attachments (optional)- allow operator to thread the attachment onto extruding bolt threads. (Figure 23 and its inset show an example of a threaded attachment.)

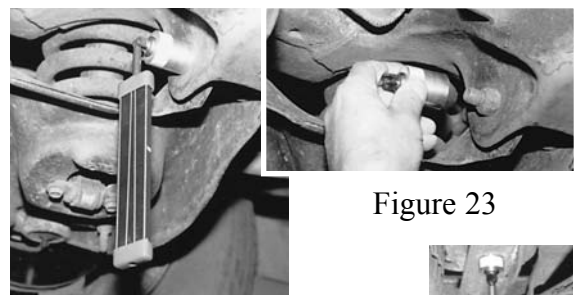

Figure 23

Long Targets (optional) - allow operator to mount Targets in the end sections of high ground clearance vehicles. (See Figure 24.) Targets 37, 38, 39 and 40 feature longer stems that position the Target's reflective face on same plane as the body scanner lasers.

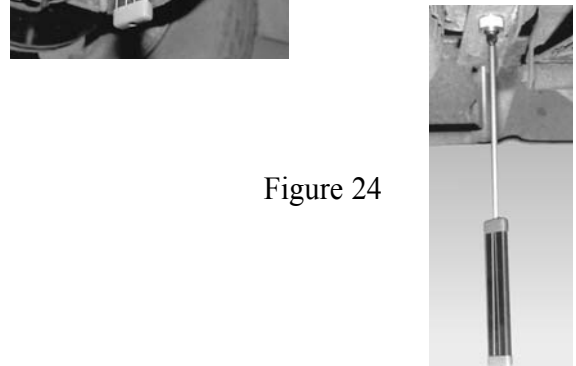

Figure 24

Optional Upper Body Bar Assembly

The Upper Body Bar Assembly (optional) consists of two horizontal bars joined by a pair of Vertical Scales. (See Figure 25.)

Pointers project from Pointer Housings on Upper Bar to strut tower or other upper body reference points. Pointers are provided in 'cone - shaped' configurations in lengths of 102mm and 178mm.

Three Targets (Nos. 43, 44, 45) mounted to Lower Bar measure height, width (centerline), and length of strut tower or other upper body reference points.

In addition to components listed, Bolt Hole Caps and Stud Hole Caps (ranging from 5 to 17mm in diameter) allow the assembly to be mounted to open bolt holes or studs. (See Figures 26 and 27.) The configuration of the cap positions the pointer at center of hole or stud.



Figure 25

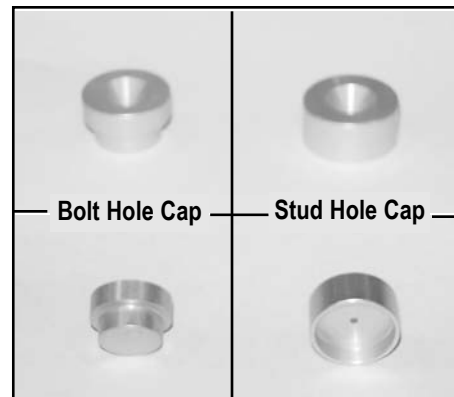

Figure 26



Figure 27

Optional Upper Body Bar (continued).....

To install the Upper Body Bar, attach one of the Vertical Scales to Upper Bar and place assembly's pointers on reference points. (See Figure 28.) Then tighten Pointer Housings (see Figure 29); however, if a reference point appears to be misaligned, do not tighten its Pointer Housing. Next, install Lower Bar (with three Targets installed) and remaining Vertical Scale. If needed, adjust height of Lower Bar to enable Body Scanner to view all three Targets.

IMPORTANT:

- 1) Target Number 45 must be in center of Lower Bar and Target Numbers 43 and 44 must be under their respective Pointers. (See Figure 30.)
- 2) Body Scanner's Lasers should strike near center of Target faces.
- 3) Length of Vertical Scales must be equal, one side of vehicle to the other.



Figure 28



Figure 29



Figure 30

Spacers and 3 Inch Bolts

The Vector Measuring System works well with all of Chief's anchoring systems; however, a slight modification may be required if using Chief's original Universal Anchoring System. Whenever the anchoring tubes of this system prevent the mounting of Targets in the rear corners of the vehicle's center section, operators should offset the clamp bars using the spacers and 3 inch bolts provided. (See Figure 31.) The spacers and bolts position the rear anchoring stands wider than normal allowing Targets to hang vertically.

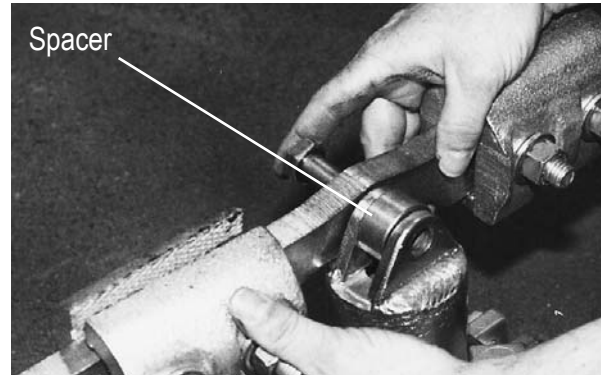

Figure 31

(Spacers and 3-inch bolts are provided for offsetting clamp bar on some anchoring equipment.)

Chief Specifications Data

Specifications of domestic and foreign vehicles are stored in the Vector Computer along with provisions for periodic updates.

Literature

Literature provided with Vector system includes Vector Users Manual, Vector Parts Manual, and Vector Assembly Guide. Also included are the users manuals for the Computer, Microsoft Windows®; and the Printer.

In addition to this printed literature, the Vector system features an On-Line Help Text and a Tutorial (requires optional speakers to listen) that is readily accessible whenever using the program. In addition, there is also an On-Line How To Use Help System. (These Help features are addressed in greater detail later in this manual.)

Diskettes and CDs

When using diskettes or CDs, handle them correctly. To insert diskette, slide it carefully into the computer drive slot (label up and sliding door first — see Figure 32) until it seats in the drive. To remove diskette from drive slot, select Eject (from menu options on screen). Grasp diskette at label and slide it from drive slot. To insert a CD, open CD Tray, grasp CD by its edges (see Figure 33) and position CD (label up) in center of tray. Push CD tray into Computer until it seats in drive slot. To remove CD, select Eject (from menu options on screen.). Grasp edges of CD, and return it to protective case.

Update Diskettes and CDs

The computer provided with the Vector system comes fully loaded with operational software, Vehicle Graphics and vehicle specifications. Periodic updates to these are made available as needed. Updates are sent in CD format. To make updates, refer to procedures identified in Help Text and any special instructions mailed with the update CD.

Backup Diskettes

Although the computer hard drive stores important data, it is advisable to store this data on backup diskettes. (See Figure 34.) Vector operators should maintain a supply of good quality, double-sided, high-density, formatted diskettes and observe the handling rules manufacturers commonly print on the labels. When making backups, label diskettes clearly and carefully as they are used. To make backups, refer to procedures identified in Help Text.



Figure 32



Figure 33

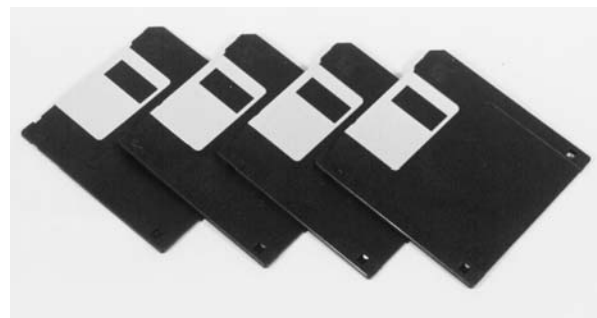

Figure 34

COMPONENT MAINTENANCE

(See also Users Manuals For Computer And Printer)

Other than cleaning, factory maintenance by qualified technicians is required for all components. Be sure system's power is **'off'** while cleaning is performed. In dusty or dirty environments, periodic cleaning is necessary. Specific instructions for cleaning critical components are described below.

Wipe all parts clean using a lint-free, low-abrasion cloth using only an ammonia-based glass cleaner. Never use solvents or alcohol-based cleaners of any kind on any part of the Vector System.

Workstation Air Filters

After disconnecting Workstation power source, remove air filters and wash them in warm water and a mild detergent. Shake off excess water, allow to dry, and reinstall.

Body Scanner Care

Do not plug or unplug cable from Body Scanner unless it is turned off.

Keep Body Scanner away from areas being undercoated, primed or painted. Keep heat away from Body Scanner when using a torch for thermal stress relieving of structural components.

Clean all Body Scanner parts with a lint-free, low-abrasion cloth and a good quality glass or ammonia cleaner. Never use solvents or alcohol-based cleaners on Body Scanner glass.

Care of Targets

Keep Targets away from areas being undercoated, primed or painted, and away from heat when using a torch for thermal stress relieving of structural components.

Use a lint-free, low-abrasion cloth and a good quality glass or ammonia cleaner to clean Targets. Do not use solvents.

Avoid scratching or gouging the Target's reflective surface.

Workstation (Keyboard, Monitor, Computer)

Clean monitor screen and other external parts (keyboard, computer, etc.) with a lint-free, low-abrasion cloth, and a good quality glass or ammonia cleaner. Do not use solvents or alcohol-based cleaners on Monitor screen or other computer parts. Be sure system's power is **'off'** while cleaning is performed.

Do not remove the clear, plastic skin covering Keyboard. Wipe it clean with a soft cloth. (See Figure 35.)



Figure 35

*

* Lint-free, low abrasion cloth.

COMPONENT TROUBLESHOOTING

The Vector computerized measuring system contains on-line troubleshooting assistance designed to identify and eliminate problems that arise when using the system. In most instances, troubleshooting problems are signaled by “Error Messages” that appear on screen. The Vector Help Text contains information and possible solutions for these “Error Messages”.

There are two methods of accessing troubleshooting assistance.

- Press F1 Key on Keyboard when “Error Message” appears. This method accesses a specific Help Page immediately.
- Access Help Index by Menu selection or Tool Bar Icon. Then select Troubleshooting to access a specific menu. Each selection made in this process channels the operator to the help that’s desired.

Although “Error Messages” identify problems when the Vector system is running, they obviously cannot identify problems when the system is down. The following suggestions are provided when the system’s major components are not functioning. In addition to information listed here and in the Vector Help Text, refer also to User’s Manuals for the Computer and Printer. If troubleshooting problem(s) can not be solved after reviewing these sources of information, contact Chief Automotive Technologies for assistance. (See Page 5 for instructions.)

No Power To System Components

Computer, Monitor, Keyboard, Mouse, Body Scanner, Printer

- Make sure the Vector system is connected to a live power source. (Dependent upon model used, power source might be 110-volt, 15 amp or 220-volt, 5 amp.) A single purpose line for the Vector is recommended. Do not use circuits subject to frequent interruptions or outages. Also, avoid circuits with power surges, such as from welders and some power tools.
IMPORTANT: Voltage requirements may vary in some countries.
- Check all electrical and cable connections (i.e. power source, back of Workstation, inside Workstation, back of Computer, back of Printer, end of Body Scanner).
- Check fuses on back of Workstation and replace if blown.
- Inspect all electrical wiring and cable for damage or wear.
- Make sure ‘on’/’off’ switches are in ‘on’ position (Computer, Body Scanner, Printer).

III. VECTOR PROGRAM

STARTING UP VECTOR SYSTEM

Turn system power switch 'on'. (Figure 36 shows switch at rear of workstation.)

Computer will examine its circuits and prepare to run the Vector system. This process is called 'booting up the computer'. It takes several seconds to complete.

When the Vector 'Title Screen' (opening window) is displayed (see Figure 37), the 'booting up' procedure is complete.



Figure 36

NOTE: On computer systems running Windows XP, Windows 2000, Windows NT 4.0 or higher, the VectorTitle Screen will appear as shown in Figure 37.

- | | | | |
|---|-----------------------|---|--------------------|
| 1 | Select a Task | 3 | Finish Measurement |
| 2 | Start New Measurement | 4 | Recall Measurement |

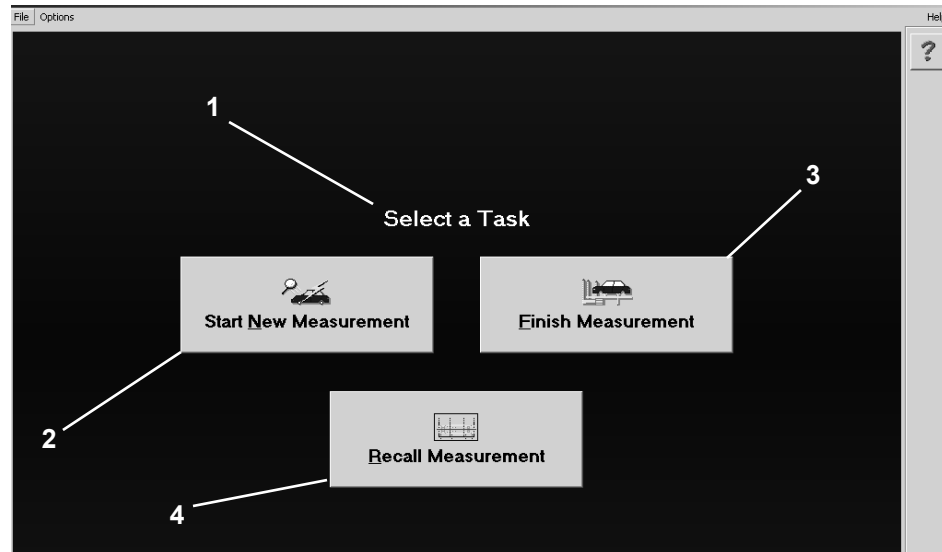

Figure 37

VECTOR TITLE SCREEN —
OPENING WINDOW

The Vector Title Screen allows the operator to either **Start New Measurement**, **Finish Measurement**, or **Recall Saved Measurement**.

When selecting “**Start New Measurement**”, Dialog Boxes appear allowing the operator to quickly identify the year, make, model and body style of the vehicle to be measured. In regard to the input of customer and/or work order information this can be entered at the same time vehicle is selected (“advanced” mode) or when the first measurement is saved (“basic” mode). See Preferences — “User Options” below.

When selecting “**Finish Measurement**”, a Dialog Box allows the operator to select the desired vehicle from a list of vehicles that have not yet been finished.

When selecting “**Recall Saved Measurement**”, a Dialog Box allows the operator to search for the vehicle by customer name, vehicle description or work order number.

PREFERENCES

The Vector Title Screen also allows operators to access the system’s **Preferences Dialog Box**. (See Figure 38.) Tabs within this box allow operators to tailor the program to suit their individual needs. Through the User Options, Vector Setup, Printer / Reports, Network Setup and Quick Entry Setup “Tabs”, operators may select, for example, the ‘basic’ or ‘advanced’ mode of operation, the items they want to appear on printed reports, identify computer links, ‘activate’ or ‘deactivate’ tools and determine certain ‘default’ settings.

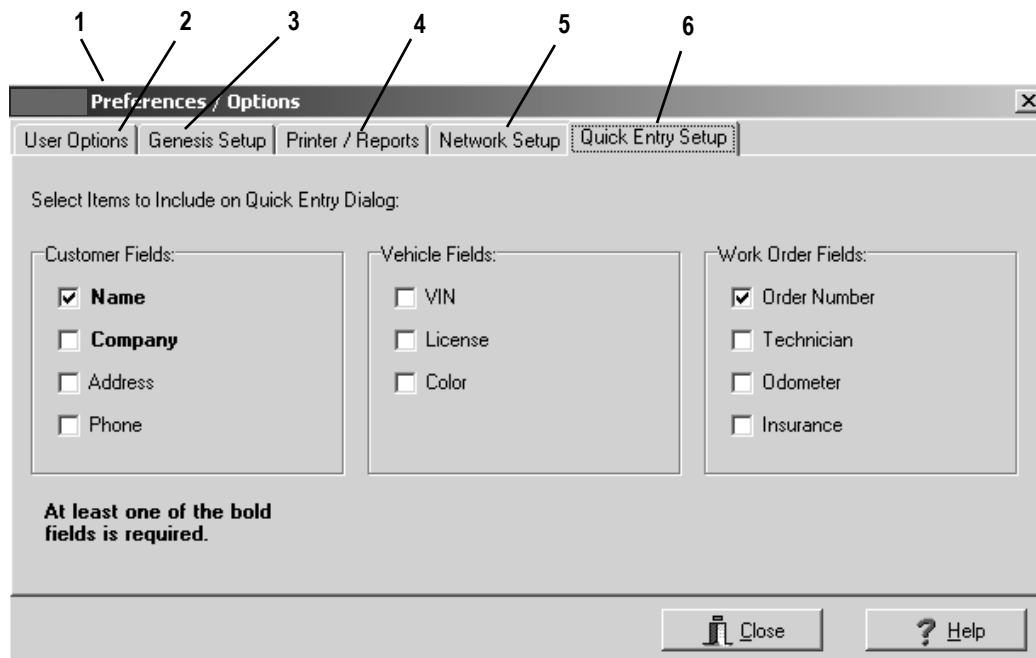

1 General Preferences / Options

2 User Options

3 Vector Setup

4 Printer / Reports

5 Network Setup

6 Quick Entry Setup

Figure 38

VECTOR WINDOWS AND MENUS

The Vector software features five operational Windows. These include: Title Screen — Opening Window; Initial Inspection — Base Reference Entry; Repair; Final Inspection; and, Recall. Each Window features a Menu Bar that identifies operations or commands that are specific for that Window. See explanation of Windows and an example on pages 24 and 25. (See also Vector Help Text and Tutorial. Optional speakers required to listen to Tutorial.

Menu selections appearing below the Menu Bar headings identify tasks the system is ready to perform. To make selections, operators have the option of using either the Keyboard or Mouse devices or a combination of the two. (Specific information on using the devices is covered on Pages 30 through 32 of this manual and in the Vector Help Text.) Menu selections that appear dimmed are inaccessible.

NOTE: Tool Bar Icons (Buttons) provide a faster way to perform tasks than the menu selection method. (See Tool Bar Icons / Buttons in Vector Help Text.)

The selection of menu items or tool bar items often prompt the appearance of Dialog Boxes on Screen. Dialog Boxes allow operators to supply additional information to complete a task. Some Dialog Boxes require a selection from a list of options whereas others require the inputting (typing) of information. See explanation of dialog Boxes and examples on pages 26 and 27. (See also Vector Help Text.)

IMPORTANT:

Refer to Help Text for a more detailed description of menu selections. Tool Bar Icons (Buttons) and related procedural information. For information on how to use Help, see Pages 37-39 or access the How To Use Help System. Refer also to User's Guide for Microsoft Windows.

SHUTTING DOWN VECTOR SYSTEM

To shut down the Vector System, first save all necessary information if needed. Then select Exit from list of items under File heading in menu. (See Figure 39.) Then access Start Menu List, select Shut Down and turn off power switch at rear of Workstation.

File	Vehicle	Options
Update		
Back Up		
Restore		
Exit		

Figure 39

WINDOWS

The Vector program is provided in a Windows software format that allows operators to manage work easily and efficiently. All work applications appear on Windows which are basically large rectangular areas on screen. Most Windows have certain elements in common, for example: Title Bar, Menu Bar, etc. Not all Windows, however, have every element.

In addition to elements that appear on a Window, there are other elements that appear along the right side or bottom edge of Window. Such elements vary from one Window to another.

Figure 40 (see next page) identifies some of the basic elements that appear either directly on Windows or at the right side or bottom edge of Windows. Elements identified on the illustration are described below. The illustration displayed is representative of an Initial Inspection Window (Base Reference Entry).

To work within a Window, operators have the option of using the Keyboard or Mouse or a combination of the two. Specific information on using these devices appears on Pages 30 through 32 and in Vector on-line Help Text.

Title Bar - Identifies Window. (Located across top of Window.)

Menu Bar - Identifies Menu Headings. (Located across top of page below Title Bar.)

Menu Headings - Identifies menu lists that are available.

Menu List - Identifies tasks computer is ready to perform.

Scroll Bars - Used to expand Window when enlarged image of Vehicle Graphic exceeds display area.

Tool Bar Icons (Buttons) - Used to perform certain functions quickly. Graphic suggests purpose or identity of function.

Status Bar - Systematically appears at bottom of Window to provide on-screen help throughout the Vector Program. Brief messages either instruct the operator as to next course of action or describe purpose of menu selections or Tool Bar Icons.

Dialog Box - Box that appears on Window for inputting, viewing or editing information.

Vehicle Graphic - Top view of vehicle's sub-structure showing reference point locations, vehicle measurement, and direction of misalignment. (See additional information on Vehicle Graphics on Pages 28-29.)

Wizard - On screen messages designed to guide the operator through software procedures. Each message allows the accessing of more information, including photos and videos in some cases, or advancement to the next step.

WINDOW EXAMPLE

- | | | | |
|---|------------------------------|----|---------------------------------------|
| 1 | Menu Bar | 7 | Menu Headings |
| 2 | Title Bar | 8 | Status Bar |
| 3 | Point Information Dialog Box | 9 | Vehicle Graphic (specifications mode) |
| 4 | Scanner View Dialog Box | 10 | Wizard 'On' / 'Off' |
| 5 | Menu List | 11 | Tool Bar Icons |

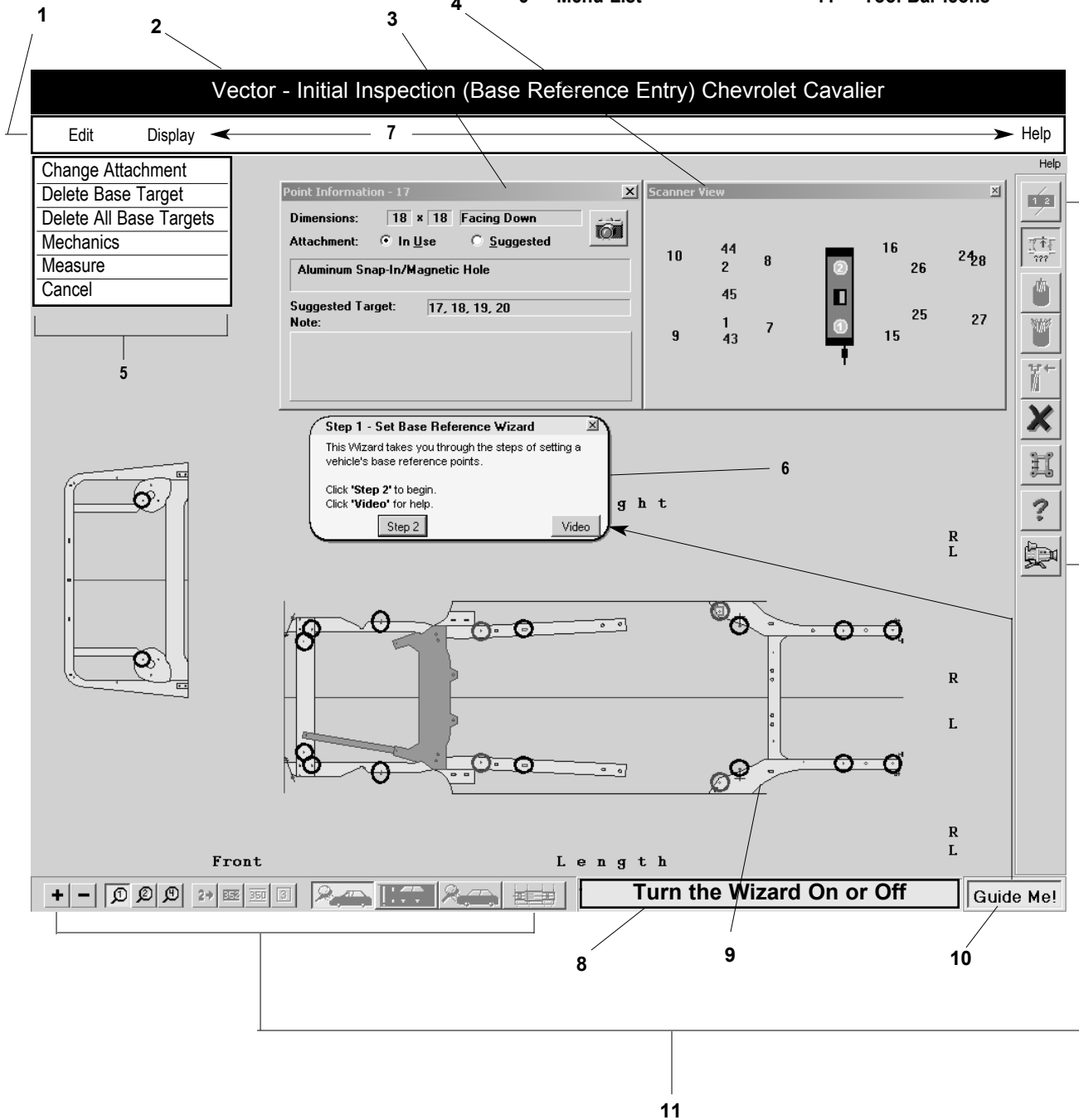

Figure 40

DIALOG BOXES

Dialog Boxes appear on a Window when operator must supply additional information to complete a task or when operator needs to access information. Most Dialog Boxes require selection of options, whereas others require inputting (typing) of information. Most Dialog Boxes have elements in common, for example: Title Bars, Command Buttons, and Control-Menu Symbol Button. Not all Dialog Boxes have every element.

Figures 41-43 identify some of the different styles of Dialog Boxes and some of the different elements within Dialog Boxes. Figure 41 (see page 27) shows a Customer Data Entry Dialog Box; Figure 42 shows a Scanner View Dialog Box; and Figure 43 shows a Point Information Dialog Box. Elements that appear in these Dialog Boxes are described below. To work within or move a Dialog Box, operators may use the Keyboard or Mouse device or a combination the two. Specific information on the use of these devices within Dialog Boxes appears on Pages 30-32 and in Vector on-line Help Text.

Title Bar - Identifies Dialog Box. (Located across top of Dialog Box.)

Command Button - Used to perform certain functions quickly. Graphic suggests purpose or identity of function.

Field - Specific line for inputting, viewing, editing information.

Cursor - Operator controlled indicator that appears on Windows, Dialog Boxes, and Help Pages. Changes shape as per application.

List Box - Listing of choices that are available.

Close Button - Used to remove Dialog Box from Window. (Located in upper right corner of Dialog Box.)

Scroll Bars - Used to expand List Box when information exceeds display area.

Target Numbers - Numbers in Scanner View Dialog Box represent Targets mounted to vehicle and are displayed as per their positioning relative to the Body Scanner.

Cone (Scanner View) - Identifies Target(s) not seen by the Body Scanner.

Body Scanner - Graphic in Scanner View Dialog Box represents Body Scanner. Laser Hubs are identified as Hub 1 (on left side of vehicle) and Hub 2 (on right side of vehicle.)

Radio Button - Diamond-shaped indicator on Dialog Boxes that identifies component in use or component that is suggested.

Control-Menu Symbol - Accesses Menu List for Restore, Move, Size, Minimize, Maximize and Close Functions.

DIALOG BOX EXAMPLES

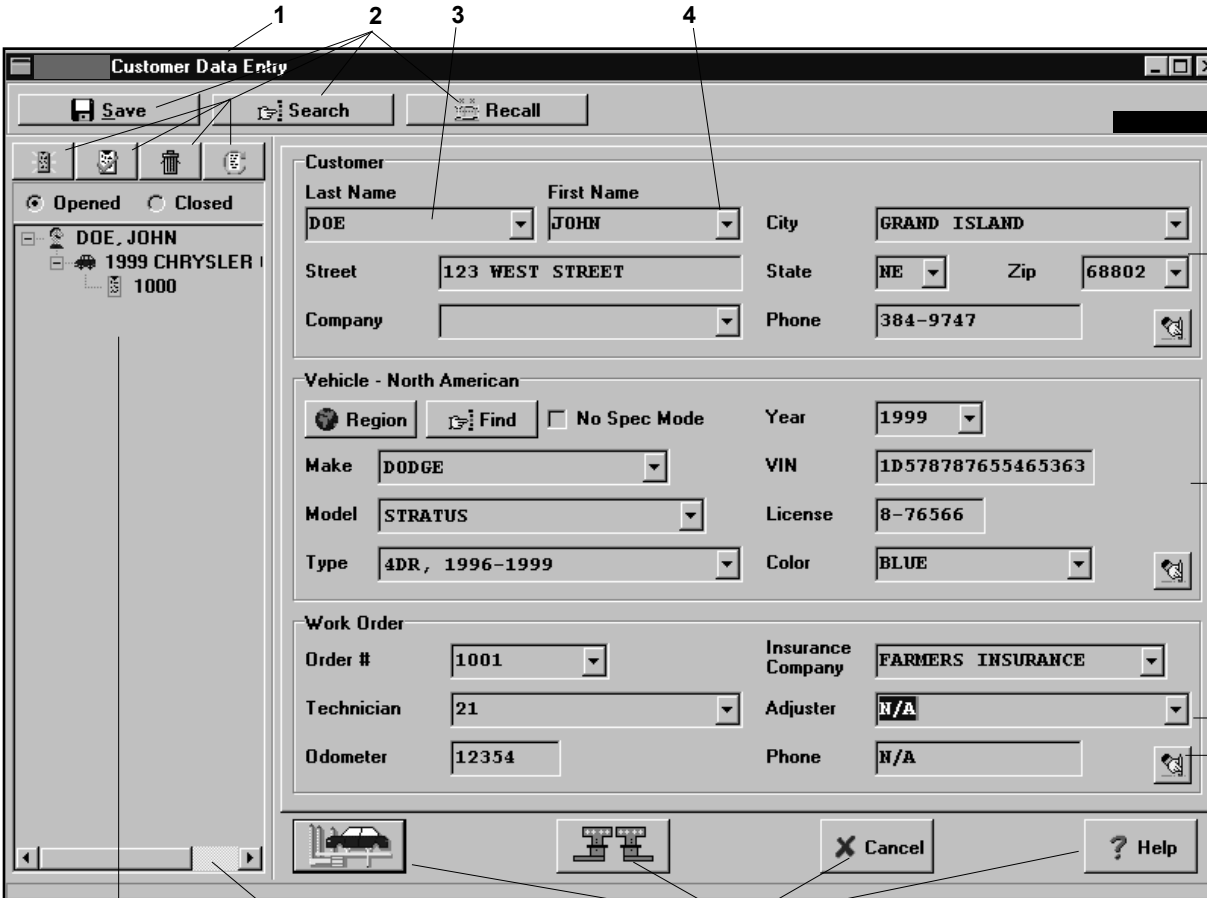

- | | | | |
|--|----------------------------|------------------------------|----------------------------------|
| 1 Title Bar | 5 Customer, Vehicle, Work | 8 Erase Button | 13 Close Button |
| 2 Command Button | Order Information Sections | 9 Body Scanner Hub | 14 Cone |
| 3 Field | 6 Customer, Vehicle, Work | 10 Control-Menu Symbol | 15 Target Number |
| 4 Down Arrow (accesses list box with scroll bars.) | Order Tree | 11 Minimize, Maximize, Close | 16 Error Message |
| | 7 Scroll Bar | 12 Radio Button Indicator | 17 Camera Icon (photo available) |

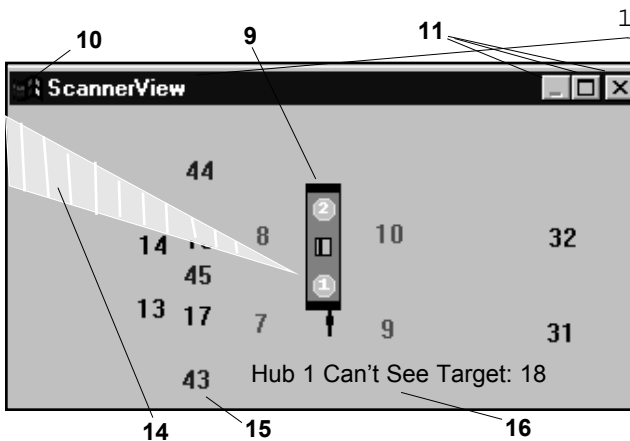

Figure 42
27

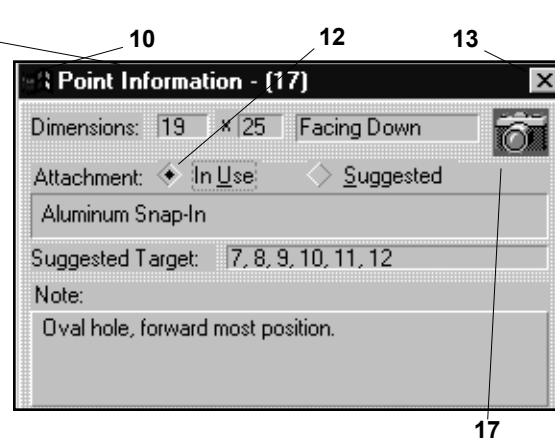

Figure 43

VEHICLE GRAPHICS

Vehicle Graphics are top view drawings of a vehicle's structural components. In the Vector program, they appear on all Vector Windows. Vehicle Graphics match make, model, and year of vehicle identified in the Vehicle Information Dialog Box. Although each Graphic shows general shape and location of reference points, program's Zoom feature allows operator a closer, more detailed look.

Vector measurements are displayed on Vehicle Graphics. (See Figure 44.)

Datum Height Measurements appear in boxes across the top of Vehicle Graphic with top numbers representing the right side of vehicle and bottom numbers representing the left side.

Centerline Width Measurements appear directly on Vehicle Graphic with numbers above centerline representing the right side of vehicle and numbers below centerline representing the left side.

Datum Length Measurements appear along the horizontal line at the bottom of Vehicle Graphic with numbers above the line representing the right side of vehicle and numbers below the line representing the left side. Datum length measurements originate at the Body Zero Line/Plane which can be established at front or rear of vehicle's center section. This line/plane is identified by its width measurements that appear inside a solid box.

NOTE: Indicator lines link reference points on Vehicle Graphic to their respective measurements.

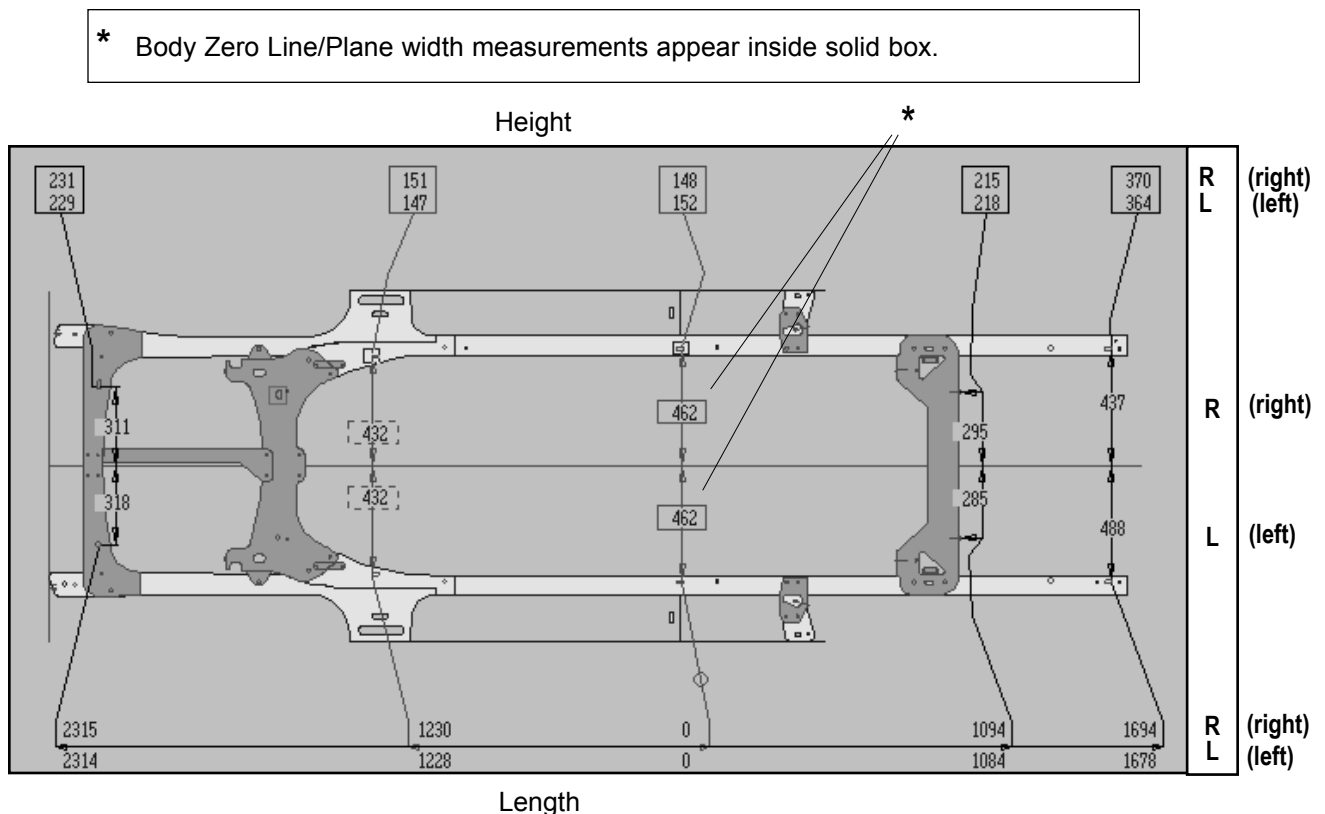

Figure 44

Measurements can be displayed in three different modes: Arrow, Actual Measurements and Specifications.

Arrow mode shows direction and amount of misalignment for each reference point measured. (See Figure 45.) Arrows indicate direction of misalignment and numerical references indicate amount of misalignment . . . difference between actual measurement and vehicle specification. Whenever amount of misalignment exceeds allowable tolerance, arrow and numerical reference are shown in 'red'. When it is within allowable tolerance, they appear in 'blue'.

Actual Measurements mode shows only current measurements taken by Vector. (See Figure 44 - previous page.) When specifications don't

exist in the Vector data base, this mode can be used to repair structure through comparison measurements.

Specifications mode shows only a vehicle's published specifications as obtained from the Vector Data Base. It is for reference purposes only.

Target Graphics and/or Target Numbers appear on the Vehicle Graphic in certain situations. For example: When entering Base Reference Targets, or when selecting Make Point, Move Target, Freeze or Thaw options. The appearance of such Targets on the Vehicle Graphic allows operator to work with Targets as per the application.

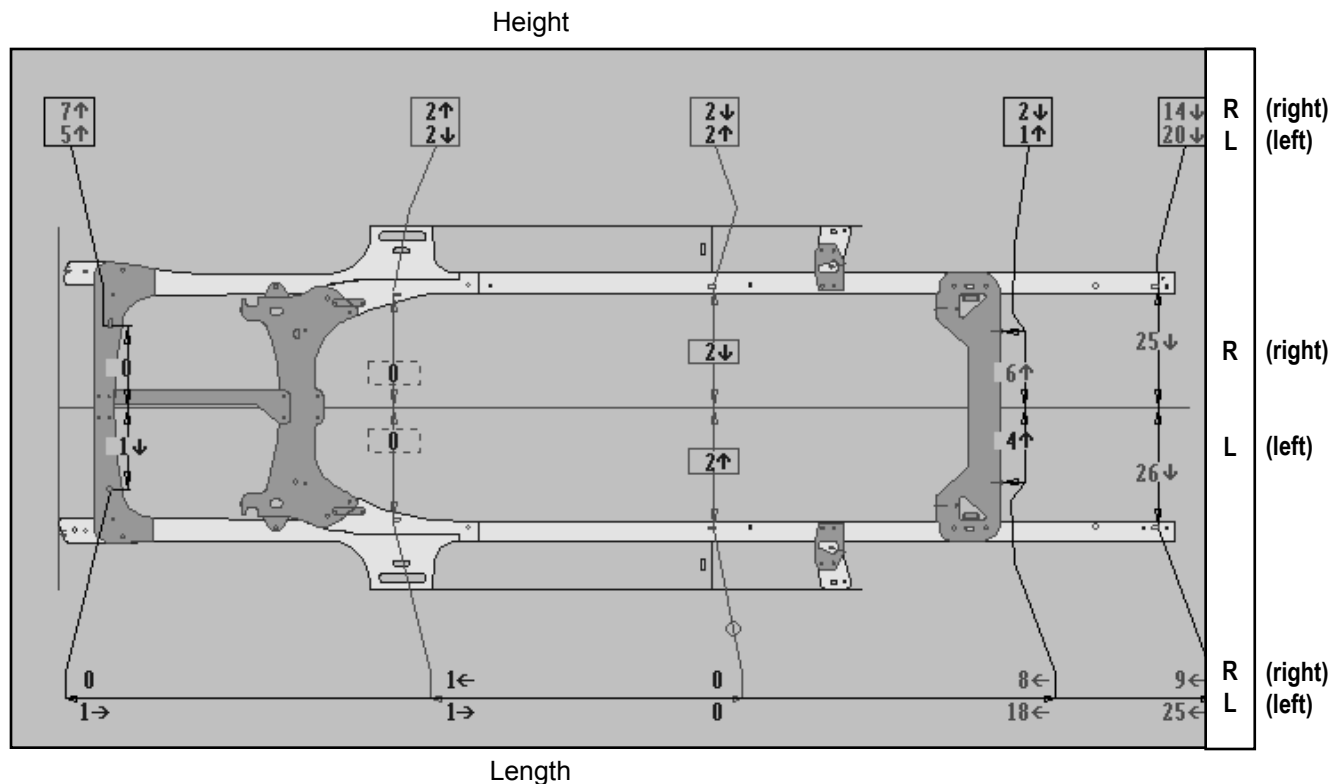

Figure 45

KEYBOARD AND MOUSE

The Keyboard and Mouse are used to operate the computer program. (See Figures 46 and 47.) The system can be operated using either device or a combination of the two. The most efficient method of operation is to use the Mouse in combination with the Keyboard. The following information addresses each device individually providing specific information pertinent to its use with the Vector program.

KEYBOARD

The following Keyboard procedures relate to specific Vector applications. For information on common Keyboard operations (i.e. typing text, editing text, etc.), refer to Special Keys Section of this manual (see Pages 31-32) and read User's Guide For Microsoft Windows.

Menus

To select Menu Bar headings on Windows, use a two key combination. Press and hold down one of the Alt Keys and then press underlined letter in heading. For example: Combination Alt + F accesses File heading. To select a menu item below heading, press only underlined letter of the item's name. Then press Enter Key.
NOTE: Menu items below headings can also be selected using Arrow Keys and Enter Key.

Vehicle Graphic

To move Cursor around Vehicle Graphic when entering Base Reference Point Targets, use Arrow Keys.

Dialog Box

NOTE: The following does not apply to Mechanics Dialog Box which requires use of Mouse device.

To work within a Dialog Box:

1. Press Tab Key to access appropriate Fields, Command Buttons, or Control-Menu Symbol. To back track, hold Shift Key down and press Tab Key.
2. Type information in appropriate Fields or scroll for it when List Boxes appear. Arrow Keys scroll one item at a time and Page Up and Page Down Keys scroll one group of items at a time.
3. Select appropriate Command Button and press Enter Key.



Figure 46

4. In some Dialog Boxes, move indicators using a two key combination. Press and hold one of the Alt Keys and then press underlined letter of the selection.

IMPORTANT: When working in a Dialog Box, DO NOT press Enter Key until pertinent information has been inputted and appropriate Command Button has been selected. The only exception to this pertains to Shop Information Dialog Box where it is necessary to use Enter Key during inputting process.

To “Move”, “Close”, And / Or “Activate”

1. To move a Dialog Box using Keyboard, press Alt + Space Bar. Then select Move from menu and press Enter Key. Use Arrow Keys to move Dialog Box to appropriate location and then press Enter Key again.
2. To close a Dialog Box using Keyboard, access Control-Menu Symbol (upper left corner) and press Enter Key. Then use Arrow Keys to select Close and press Enter Key again.
3. When two Dialog Boxes are displayed at same time, only one will be activated. To activate the other, press Alt + F6 Key. Title Bar of activated Dialog Box will appear highlighted.

To Access “Vector Help Pages”

1. To access Help Index, press F1 Key upon accessing a Vector Window or select Index from list of items under Help heading in any Menu Bar.
2. To access specific Help about information displayed (i.e. highlighted Menu items, Dialog Boxes, Vehicle Graphics, Status Bar Messages, Error Messages, etc.), press F1 Key.

NOTE: In regard to Dialog Boxes, specific Help can also be accessed by selecting Help icon which appears in most Dialog Boxes.

To Access “How To Use Help”

To access How To Use Help, first access any Vector Help Page. Then press F1 Key or select How To Use Help from list of items under Help heading in Menu Bar.

To Access “Tutorial”

To access Tutorial, access Help Index and select Vector Tutorial. (See Video Camera Icon.) Optional speakers required to listen to Tutorial.

MOUSE

To operate the Mouse (see Figure 47), move it across the pad. This action positions the Cursor at desired menu item or Tool Bar Icon (Button) on Window or to desired Field or Command Button in Dialog Box. To select (activate) the item chosen, press and release (click) left side button on Mouse. Also use clicking method to activate Scroll Bars and make selections from List Boxes.

Dialog Box

1. To move Dialog Box, move Cursor to Title Bar and then press and hold left-side button on Mouse while dragging Dialog Box to desired location. Then release.
2. To remove Dialog Box from Window, move Cursor to Control-Menu Symbol (upper left corner). Upon accessing List Box, select Close option.
3. When two Dialog Boxes are displayed at same time, select non-active Dialog Box by positioning cursor on that box and pressing and releasing (clicking). Title Bar of activated Dialog Box will appear highlighted.

To Access "Vector Help Pages"

1. To access Help Index, select Index from list of items under Help heading or select Help icon in Tool Bar at right side of screen.
2. To access Help page that relates to a specific Dialog Box, select Help icon which appears within the Dialog Box.



Figure 47

To Access "How To Use Help"

To access How To Use Help, select How To Use Help from list of items below Help heading at top of any Help Page.

To Access "Tutorial"

To access Tutorial, first select Index from list of items under Help heading or select Help icon in Tool Bar at right side of screen. Then select Vector Tutorial. (See Video Camera Icon.) Optional speakers required to listen to Tutorial.

To Access "Wizard"

To access the "Wizard" on-screen help messages (Initial Inspection — Base Reference Window only), select the "Guide Me" button in lower right corner of screen.

SPECIAL KEYS

As previously indicated, the Vector program can be operated using the Keyboard or Mouse or a combination of the two.

When using Keyboard either solely or in combination with the Mouse, operators will use not only the 'letter' and 'number' keys, but the spe-

cialty keys as well. Many of these keys provide a more convenient method for moving around in Windows, Dialog Boxes and Help Pages.

Following is a listing of special keys that are used in the Vector Program.

Alt (alternate key) — Two key combination involving Alt Key + another key.

Arrow Keys — Used to move Cursor up or down and right or left, also moves highlighted Cursor in some applications.

Backspace Key — Moves Cursor backwards to erase last character.

Control Key — Two key combination involving Ctrl Key + another key.

Delete Key — Removes one character to right of Cursor or all highlighted areas.

End Key — Moves Cursor to end of field.

Enter Key — Used in Keyboard operation only. Used to select items from menus, close Dialog Boxes, access other Dialog Boxes, enter Targets on Vehicle Graphic, select Command Buttons, dispose of Help Pop-ups. Serves same function as Mouse button.

Escape Key — Used in Keyboard operation only. Used to back up within Menus and serves same function as  Command Button on Dialog Boxes.

Function Keys — Keys marked F1, F2, F5 and F6 are Special Keys that perform special functions.

F1 — Function Key for Help.

F2 — Function Key to save measurements.

F5 — Function Key to measure one time.

F6 — Function Key to start or stop continuous measuring.

Home Key — Moves Cursor to beginning of field.

Insert Key — Inserts text without erasing other text.

Num Lock Key — On/Off Key for cluster of number keys on lower right side of Keyboard.

Number Keys — Two sets of Number Keys available on Keyboard.

Page Down Key — Used for scrolling downward through page when text extends beyond Window.

Page Up Key — Used for scrolling upward through page when text extends beyond Window.

Print Screen Key — Command Key for printing current Vector Window.

Shift Key — Serves same function as typewriter shift key.

Tab Key — Used to move around in Help and in Dialog Box.

Typewriter Keys — Same as typewriter.

HELP TEXT

The On-Line Help Text provides assistance on practically all aspects of Vector computerized measuring system. Information ranges from installation of hardware components to software utilization.

The Help Text provides all the information needed to run the Vector Program. Information is presented in form of Help Pages that provide detailed information on a given subject or Help Pop-Ups which provide concise definitions of important terms or phrases. (See Example — Figure 48.)

The Vector Help Text can be accessed in a variety of ways and is available any time the system is up and running. Operators have flexibility of jumping to specific Help Pages or Pop-Ups, or they can access Index Pages if needing to search for a topic. The following information outlines various ways to access Help Text. For information on using Help Pages, refer to How To Use Help section of this manual or access on-line How To Use Help System. An additional source of information is User's Guide for Microsoft Windows®.

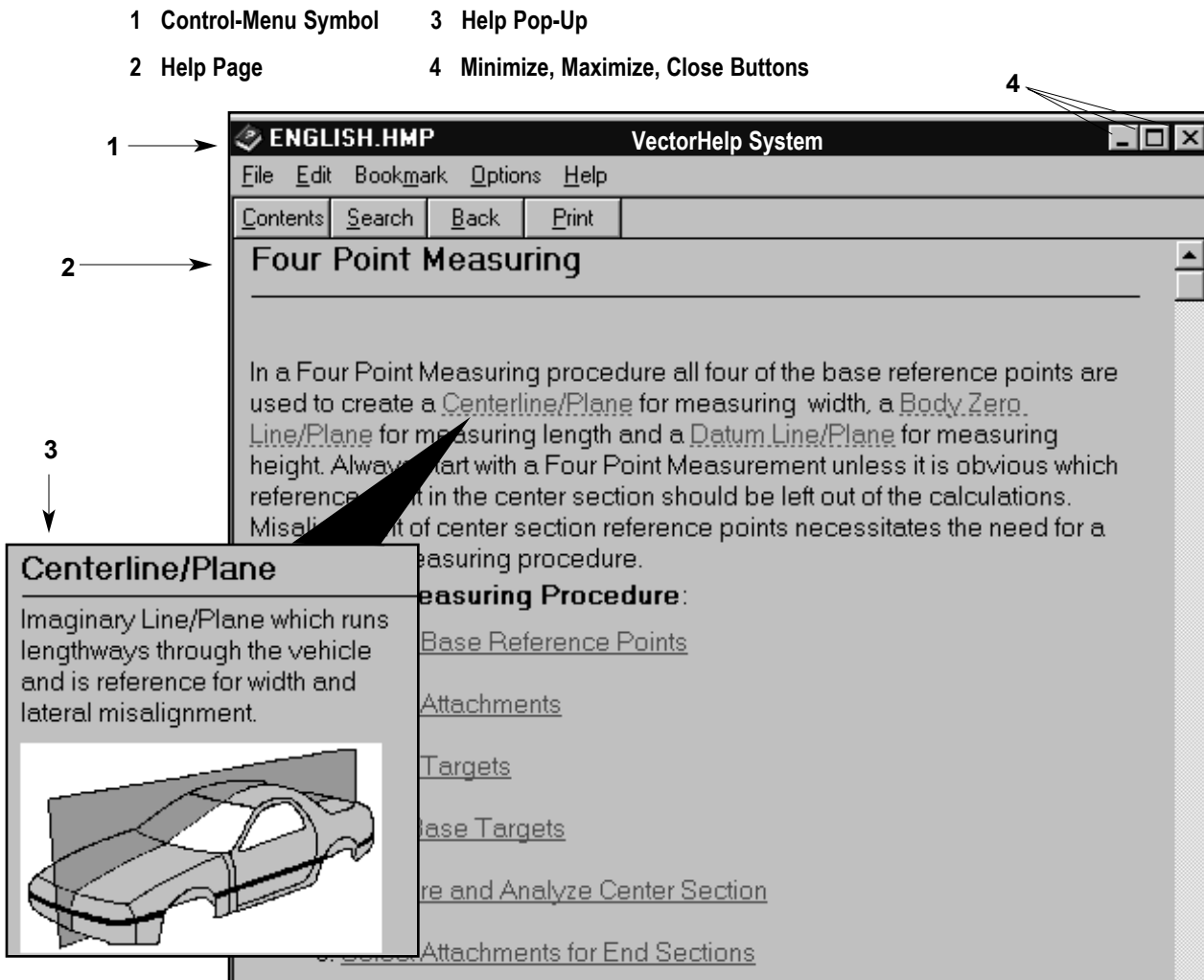

Figure 48

To Access Specific Help From Window Or Dialog Box

IMPORTANT: See Keyboard and Mouse on Pages 30 - 32 for information on moving around (and making selections) in Windows and Dialog Boxes. See How To Use Help on Pages 36-38 for information on obtaining additional help after accessing a Help Page.

- Highlight specific menu item and press F1 Key.
- Select (Command Button) in active Dialog Box or press F1 Key when active Dialog Box appears on Window.
- When there are no active Dialog Boxes on Window, press F1 Key to access definitions for that Window's Menus and Tool Bar Icons. The lone exception is when Title Bar of Window indicates Base Reference Entry. The F1 Key then accesses Base Reference Entry procedures. From this procedures page, operator has option to access definitions for Base Reference Entry Menus and Tool Bar

Icons.

NOTE:

1. Dialog Boxes are active when Title Bars are highlighted.
2. When an active Dialog Box appears, remove it from Window prior to pressing F1 Key.

- To access Help Index, select Index from list of items under Help heading or select (Help Icon) from Tool Bar.

NOTE: Upon accessing Help Index (see Figure 49), operator can select one of several categories listed. Selection of that category will access a more specific menu. Each selection made in this process channels operator to help that's desired. Camera Icon at top of Help Index page accesses the Vector Tutorial. (Optional speakers required to listen to Tutorial.)

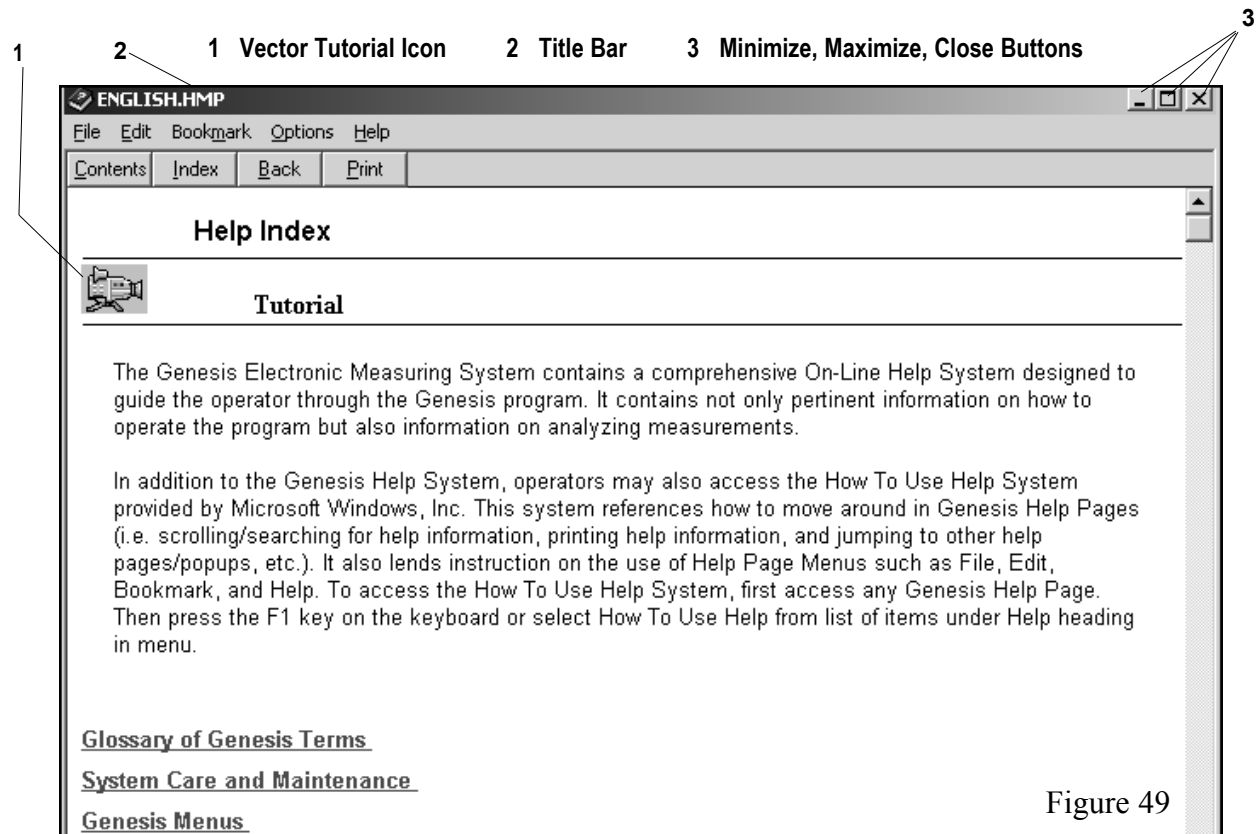

Figure 49

HOW TO USE HELP

NOTE: In addition to the following information on How To Use Help, refer to on-line How To Use Help System and User's Guide for Microsoft Windows®.

Upon accessing a specific Help Page or Index Page, operators can easily move throughout Help Text to access additional information as needed. As noted in Help Text information on Pages 34-35, the basic way to do this is by jumping from one Help Page to another Help Page or to a Help Pop-Up.

Throughout the Help Text, key words or phrases are highlighted in 'Green'. When selected, these key words or phrases serve as stepping stones that access Help Pages or Pop-Ups that relate specifically to the key words or phrases. If word is underscored with solid line, the jump goes to a Help Page; and, if word is underscored with a dotted line, the jump goes to a Help Pop-Up. (See Figure 50.)

The method of selecting key words or phrases (Icons) on Help Pages varies dependent upon use of Keyboard or Mouse. If using Keyboard, use Tab Key to advance forward from one key word

or phrase (or Icon) to the next. Use Shift + Tab Key to move back. Upon reaching desired key word or phrase (or Icon), press Enter Key. If using the Mouse, position Cursor on Key word or phrase (or Icon) . . . Cursor changes to shape of hand when correctly positioned. (See Figure 51.) Then select word or phrase (or Icon) by pressing and releasing (clicking) left side button on Mouse.

Help Pages and Pop-Ups often feature illustrations and/or photos which help clarify procedures or identify the Vector components. Illustrations appear directly on respective Help Pages and Pop-Ups. Photos do not appear directly on Help Pages and Pop-Ups; however, their availability is indicated by  (Camera Icons). To access photos, select Camera Icon in same fashion as selecting a key word or phrase.

To remove Help Pages from Window, select Close Button in upper right corner of Help Page. To remove a Help Pop-Up or a photo from the Window, press any letter key on keyboard or position Cursor on Window and press and release left side button on Mouse.

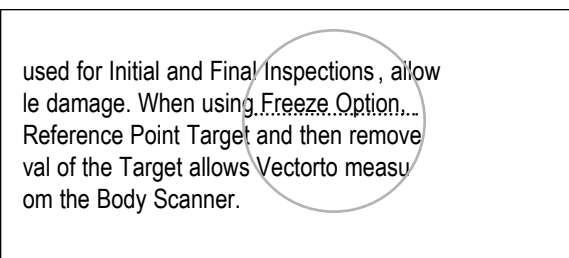

Figure 50

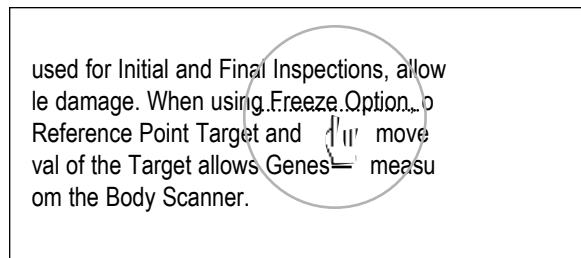

Figure 51

Help Page Features

Each Help Page in the Vector Help Text has certain elements in common. These include a Menu Bar, Command Buttons, Scroll Bars, Minimize and Maximize options and a Close option. (See Example — Figure 52.) Scroll Bars exist on some of pages.

Menu Bar allows operators to access File, Edit, Bookmark, Options and Help Functions. Command Buttons allow operator to access information quickly. Minimize and Maximize features enlarge and reduce Help Page and Close option removes it from Window. Scroll Bars allow access to information that does not fit on Window. Minimize and Maximize options allow only limited sizing of Help Page.

Using the Mouse, position Cursor at vertical or horizontal border or at corner of Help Page . . . Cursor will change to shape of double arrow. Press and hold down left side button on Mouse. Drag Cursor to enlarge or reduce Help Page and then release.

Using Keyboard, press Alt + Space Bar to access menu list below Control-Menu Symbol at left side of Title Bar. Using Arrow Keys, select Size and press Enter Key. Move Cursor (using Arrow Keys) to vertical or horizontal border or to corner of Help Page. Continue using Arrow Keys to size the Help Page. When sized correctly, press Enter Key.

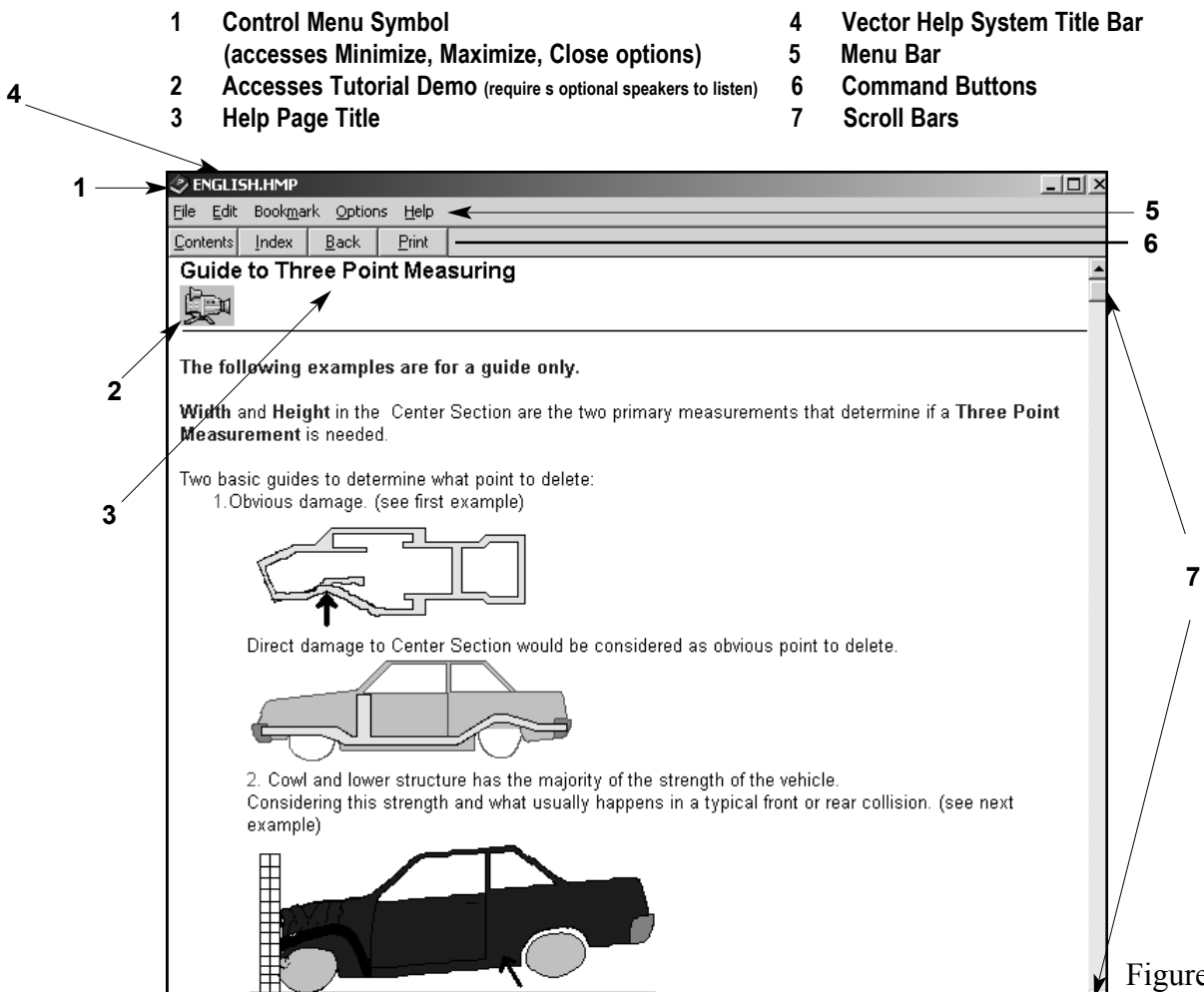

Figure 52

Help Page Command Buttons

- Contents** Command Button accesses the Vector Help Index.
- Search** Command Button accesses Dialog Box that allows operator to do an alphabetical search for desired Help Topic.
- Back** Command Button allows operator to return to previously displayed Help Page.
- Print** Command Button accesses Dialog Box that allows operator to print the Vector Help page displayed.

NOTE: When accessing on-line How To Use Help System, a **Glossary** Command Button appears with **Contents** **Search** **Back** and **Print** Command Buttons. Selection of the **Glossary** Button accesses a listing of common terms used in Windows Program. Selection of a term from list-

ing accesses its definition. To access on-line How To Use Help System, first access a Vector Help Page and do one of the following: Select How To Use Help from list of items under Help heading; or, press F1 Key.

Control-Menu Symbol

List of items under Control-Menu Symbol (see Figure 53) allows operator to restore Help Page to normal size; move Help Page to another location on Window; enlarge or reduce size of Help Page; close Help Page and return to Vector Program; or, switch to another active computer program.

NOTE: To access this menu, position Cursor on Control-Menu Symbol and press and release (click) left side button on Mouse. Using Keyboard, press Alt + Space Bar.

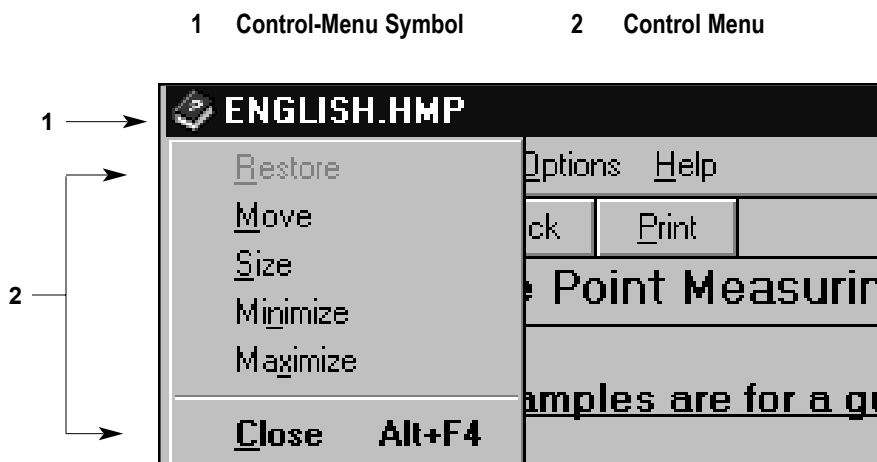

Figure 53

VECTOR TUTORIAL

NOTE: Optional speakers are required to listen to the tutorial.

The Vector Tutorial covers the basic features of the Vector system. The program is designed for both first time users and for technicians needing to review the basic fundamentals of measuring. The Tutorial not only helps technicians navigate through the system software but also covers basic measuring concepts and principles.

The Tutorial features narrated text that is complemented by detailed illustrations, photos and videos. The Tutorial is installed on the hard drive of all new Vector Systems and is also available in CD format.

The Tutorial may be accessed in two ways: from Help Index (Contents) page (click Video Camera Icon); and, from Start Menu List (click Vector Electronic Measuring and select Vector Tutorial).

Many of the videos contained in the Tutorial are also accessible from related Help Text pages. Clicking the Camera Icon (see Figure 54) on these pages accesses the video.

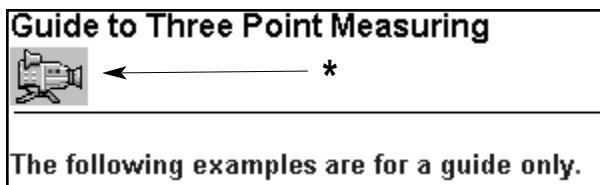

* Camera Icon
(requires optional speakers
to listen)

Figure 54

VECTOR HELP WIZARD

The Vector Help Wizard (available on newer operating systems) is an on-screen guide that assists the technician during the initial inspection process. (See Figure 55.) Following the end of each Step, the technician may advance the Wizard to the next Step or seek additional information relating to the Step at hand.

The additional information may appear as additional text, a video presentation or a still photo or illustration. The Wizard messages are accessible via the Guide Me icon located at the bottom right hand corner of the screen. (See Figure 56.)



* Help Wizard (On Screen Guide)

Figure 55

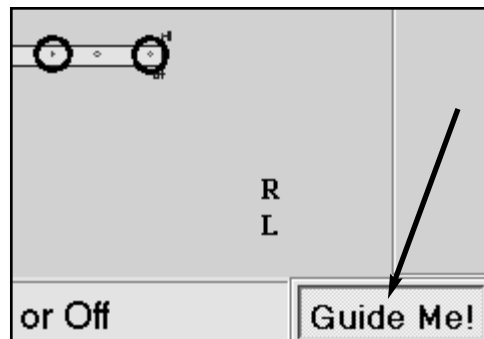

Figure 56



Chief Automotive Technologies
996 Industrial Drive
Madison, IN 47250
Phone: 800-445-9262
Fax: 866-275-0173



www.chiefautomotive.com

Chief reserves the right to alter product specifications
and/or package components without notice.