

SCREWDRIVERS



Screwdrivers	95
Extra-long screwdrivers	100
Torx screwdrivers	102
Socket screwdrivers	104

KEY WRENCHES



Offset key wrenches - hexagonal	106
Offset key wrenches - Torx	110
Offset key wrenches - Tamper Resistant Torx	111
T-Handle key wrenches	112

BITS

1/4" 10mm 5/16"

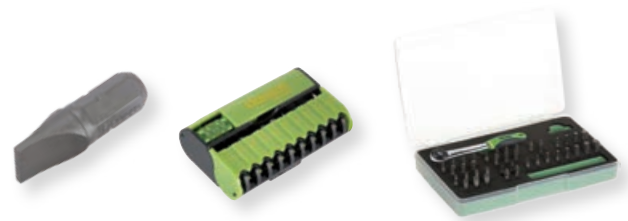

1/4" dr. bits	114
10mm bits	120
5/16" dr. bits	122

BITS ACCESSORIES



Bit holder	124
Bit holder with square drive	124
Socket holder	125

3



PLIERS



Combination pliers	126
Cutting pliers	129
Slip joint pliers	130
Bent nose pliers	131

ADJUSTABLE SELF-LOCKING PLIERS



Adjustable self-locking pliers, curve jaws	134
Adjustable self-locking pliers, C-shaped jaws	134
Adjustable self-locking pliers, fork type jaws	135
Adjustable self-locking pliers with chain	135

CIRCLIP PLIERS



Outside circlip pliers	132
Inside circlip pliers	132
External butt-ended circlip pliers	133



SPECIAL DESIGN WITH SIDE GROOVES TO INCREASE THE TORQUE DURING USE !

- soft coating with THERMOPLASTIC VULCANIZAT MATERIAL (TPV) with side grooves for an higher adherence on the handle
- ridgid parts in POLYPROPYLENE RANDOM COPOLYMER (PP), for an higher resistance of handle
- internal part in POLYPROPYLENE RANDOM COPOLYMER (PP), for a perfect housing of blades

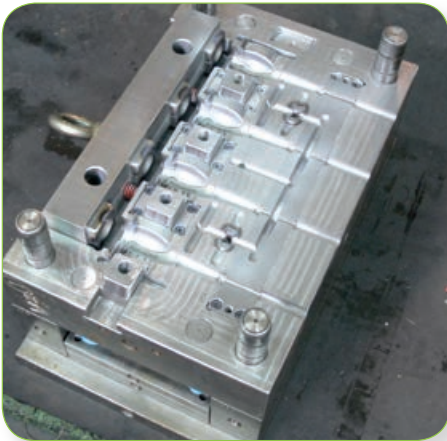

BLADES CERTIFICATED FOR HIGH TORQUE LEVEL

- satin coating, able to protect the blades from enviromental agents
- burnished tips able to work with high torque level
- magnetized tips in order to get easy the use of screwdrivers also in restricted places

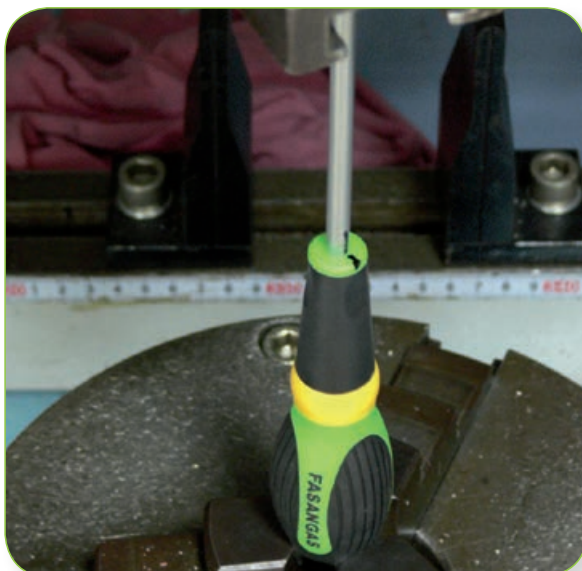

Screwdriver for slotted head screws - DIN ISO 2380

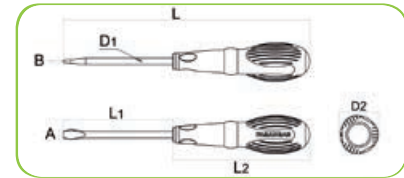

CODE	AxB mm	D1 x L1 mm	D2 x L2 mm	L/mm	Minimum	
FG 22/2.5x60	2.5x0.4	2.5X60	28.9X100.9	161	5pz	
FG 22/2.5x75	2.5x0.4	2.5X75	28.9X100.9	176	5pz	
FG 22/3x75	3.0x0.5	3.0X75	28.9X100.9	176	5pz	
FG 22/3x100	3.0x0.5	3.0X100	28.9X100.9	201	5pz	
FG 22/3.5x100	3.5x0.6	3.5X100	28.9X100.9	201	5pz	
FG 22/3.5x125	3.5x0.6	3.5X125	28.9X100.9	226	5pz	
FG 22/4x100	4.0x0.8	4.0X100	28.9X100.9	201	5pz	
FG 22/4x125	4.0x0.8	4.0X125	28.9X100.9	226	5pz	
FG 22/4x150	4.0x0.8	4.0X150	28.9X100.9	251	5pz	
FG 22/5.5x100	5.5x1.0	5.0X100	32.7X114.0	214	5pz	
FG 22/5.5x150	5.5x1.0	5.5X150	32.7X114.0	264	5pz	
FG 22/5.5x200	5.5x1.0	5.5X200	32.7X114.0	314	5pz	
FG 22/6.5x100	6.5x1.2	6.5X100	36.0X125.0	225	5pz	
FG 22/6.5x150	6.5x1.2	6.5X150	36.0X125.0	275	5pz	
FG 22/8x150	8.0x1.2	8.0X150	39.4X136.6	287	3pz	
FG 22/8x200	8.0x1.2	8.0X200	39.4X136.6	337	3pz	
FG 22/10x200	10.0x1.6	10.0X200	39.4X136.6	337	3pz	
FG 22/12x250	12.0x1.7	12.0X250	39.4X136.6	387	3pz	



Screwdriver for slotted head screws stubby series - DIN ISO 2380

CODE	AxB mm	D1 x L1 mm	D2 x L2 mm	L/mm	Minimum	
FG 22/4x30	4.0x0.8	4X30	35.4X63.5	93.5	5pz	
FG 22/6.5x30	6.5x1.2	6.5x30	35.4x63.5	93.5	5pz	

Set of screwdrivers for slotted head screws

CODE	CONTENT	
FG 22SL/S5	2.5x75, 3x75, 4x125, 5.5x150, 6.5x150	
FG 22SL/S9	2.5x60, 3x100, 4x30, 4x125, 5.5x150, 6.5x30, 6.5x150, 8x200, 10x200	
FG 22SL/S12	2.5x60, 3x100, 3.5x125, 4x30, 4x125, 5.5x100, 5.5x150, 6.5x30, 6.5x150, 8x200, 10x200, 12x250	

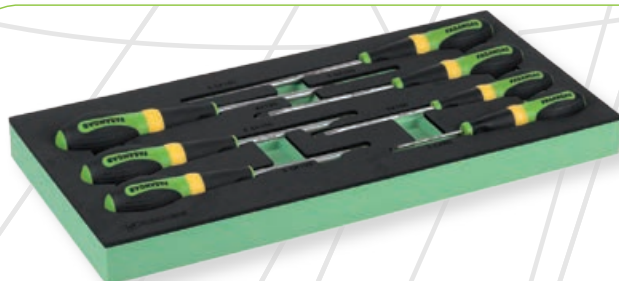

Soft form of 7pcs screwdrivers for slotted head screws

CODE	CONTENT	
FG 100/45G	2.5x60, 3x100, 3.5x100, 4x125, 5.5x100, 5.5x150, 6.5x150	



Plastic tray 7pcs screwdrivers for slotted head screws

CODE	CONTENT	
FG 102/45G	2.5x60, 3x100, 3.5x100, 4x125, 5.5x100, 5.5x150, 6.5x150	

Screwdriver for PH cross head screws - DIN ISO 8764

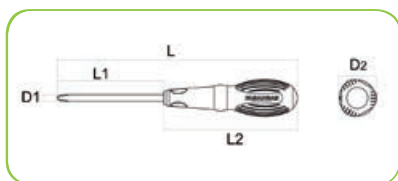

CODE	PH	D1 x L1 mm	D2 x L2 mm	L/mm	Minimum	
FG 22/PH0x60	0	3x60	28.9x101	160	5pz	
FG 22/PH1x80	1	5x80	32.7x114	194	5pz	
FG 22/PH1x150	1	5x150	32.7x114	264	5pz	
FG 22/PH1x200	1	5x200	32.7x114	314	5pz	
FG 22/PH2x100	2	6x100	36.0x125	225	5pz	
FG 22/PH2x150	2	6x150	36.0x125	275	5pz	
FG 22/PH2x200	2	6x200	36.0x129	325	5pz	
FG 22/PH3x150	3	8x150	39.4x137	287	3pz	
FG 22/PH4x200	4	9.5x200	39.4x137	337	3pz	



Screwdriver for PH cross head screws stubby series - DIN ISO 8764

CODE	PH	D1 x L1 mm	D2 x L2 mm	L/mm	Minimum	
FG 22/PH1x30	1	5x30	35.4x63x5	93.5	5pz	
FG 22/PH2x30	2	6x30	35.4x63.5	93.5	5pz	

Set of screwdrivers for cross head PH screws

CODE	CONTENT	
FG 22PH/S4	PH0x60, PH1x80, PH2x100, PH3x150	
FG 22PH/S6	PH0x60, PH1x80, PH1x150, PH2x100, PH3x150, PH4x200	
FG 22PH/S8	PH0x60, PH1x30, PH1x80, PH1x150, PH2x30, PH2x100, PH3x150, PH4x200	

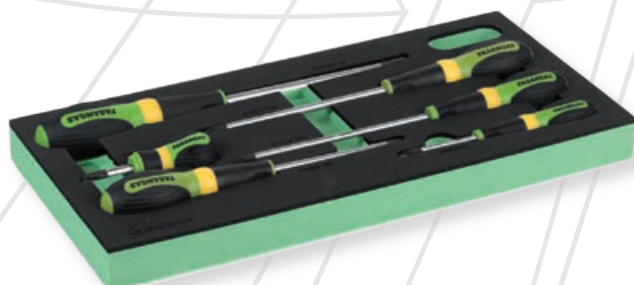

Soft form of 6pcs screwdrivers for PH cross head screws

CODE	CONTENT	
FG 100/45F	PH0x60, PH1x150, PH2x100, PH2x150, PH3x150, PH2x30	



Plastic tray of 6pcs screwdrivers for PH cross head screws

CODE	CONTENT	
FG 102/45F	PH0x60, PH1x150, PH2x100, PH2x150, PH3x150, PH2x30	

Screwdriver for PZ cross head screws - DIN ISO 8764

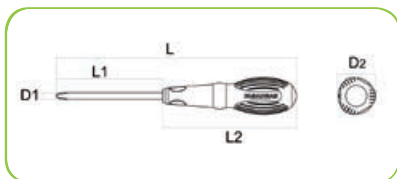

CODE	PZ	D1 x L1 mm	D2 x L2 mm	L/mm	Minimum	
FG 22/PZ0x60	0	3x60	29.9x101	161	5pz	
FG 22/PZ1x80	1	5x80	32.7x114	194	5pz	
FG 22/PZ2x100	2	6x100	36.0x125	225	5pz	
FG 22/PZ3x150	3	8x150	39.4x135	286	3pz	
FG 22/PZ4x200	4	9.5x200	39.4x137	337	3pz	

Screwdriver for PZ cross head screws stubby series - DIN ISO 8764

CODE	PZ	D1 x L1 mm	D2 x L2 mm	L/mm	Minimum	
FG 22/PZ1x30	1	5x30	35.4x63.5	93.5	5pz	
FG 22/PZ2x30	2	6x30	35.4x63.5	93.5	5pz	

Set of screwdrivers for cross head PZ screws

CODE	CONTENT	
FG 22PZ/S4	PZ0x60, PZ1x80, PZ2x100, PZ3x150	
FG 22PZ/S5	PZ0x60, PZ1x80, PZ2x100, PZ3x150, PZ4x200	
FG 22PZ/S7	PZ0x60, PZ1x30, PZ1x80, PZ2x30, PZ2x100, PZ3x150, PZ4x200	





Set of screwdrivers for slotted and PH cross head screws

CODE	CONTENT	
FG 22/S6	3x75, 4x100, 5.5x100 PH0x60, PH1x80, PH2x100	
FG 22/S8	3x75, 4x100, 5.5x100, 6.5x30 PH0x60, PH1x80, PH2x100, PH2x30	
FG 22/S8B	2.5x75, 3.5x100, 4x100, 6.5x150, 8x150 PH0x60, PH1x80, PH2x150	



Set of screwdrivers for slotted and PH cross head screws

CODE	CONTENT	
FG 22/S10	2.5x60, 3x75, 4x100, 5.5x150, 6.5x150, 4x30 PH0x60, PH1x80, PH2x100, PH1x30	
FG 22/S12	2.5x60, 3x75, 4x100, 5.5x150, 6.5x150, 8x150, 4x30 PH0x60, PH1x80, PH2x100, PH3x150, PH1x30	



Set of screwdrivers for slotted and PZ cross head screws

CODE	CONTENT	
FG 22/S7	3x75, 4x100, 5.5x150, 6.5x150 PZ0x60, PZ1x80, PZ2x100	



Soft form of 6pcs screwdrivers for slotted and PH cross head screws

CODE	CONTENT	
FG 100/45D	3x100, 4x125, 5.5x150, 6.5x150 PH1x80, PH2x150	



Plastic tray of 6pcs screwdrivers for slotted and PH cross head screws

CODE	CONTENT	
FG 102/45D	3x100, 4x125, 5.5x150, 6.5x150 PH1x80, PH2x150	



SCREWDRIVERS



Soft form of 8pcs screwdrivers for slotted and PH cross head screws

CODE	CONTENT
FG 100/45E	3x100, 4x125, 5.5x150, 6.5x30, 6.5x150 PH1x80, PH2x150, PH2x30



Plastic tray of 8pcs screwdrivers for slotted and PH cross head screws

CODE	CONTENT
FG 102/45E	3x100, 4x125, 5.5x150, 6.5x30, 6.5x150 PH1x80, PH2x150, PH2x30



Plastic tray of 12pcs screwdrivers for slotted and PH cross head screws

CODE	CONTENT
FG 102/45U	2.5x60, 3x75, 4x100, 5.5x150, 6.5x150, 8x150, 4x30 PH0x60, PH1x80, PH2x100, PH3x150, PH1x30



SCREWDRIVER FOR SLOTTED HEAD SCREWS, WITH HEXAGON BOLSTERS



CODE	AxB mm	D1 x L1 mm	D2 x L2 mm	L/mm	Minimum
FG 22/5.5x125H	5.5x1.0	5.5x125	36.0x125	250	3pz
FG 22/6.5x150H	6.5x1.2	6.5x150	39.4x137	287	3pz
FG 22/8x175H	8.0x1.2	8x175	39.4x137	312	3pz
FG 22/10x200H	10x1.6	9.5x200	39.4x137	337	2pz
FG 22/12x200H	12x1.8	12x200	39.4x137	337	2pz

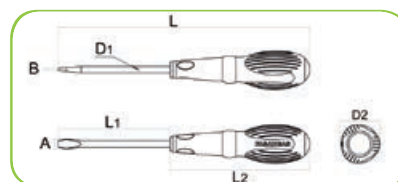

SCREWDRIVER FOR PH CROSS HEAD SCREWS, WITH HEXAGON BOLSTERS



CODE	AxB mm	D1 x L1 mm	D2 x L2 mm	L/mm	Minimum
FG 22/PH2x100H	2	8x100	39.4x137	237	3pz
FG 22/PH3x150H	3	8x150	39.4x137	287	3pz
FG 22/PH4x200H	4	9.5x200	39.4x137	337	2pz

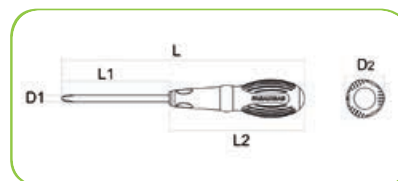

Set of screwdrivers for slotted and PH cross head screws

CODE	CONTENT
FG 22/S8H	5.5x125, 6.5x150, 8x175, 10x200, 12x200 PH2x100, PH3x150, PH4x200



SCREWDRIVER FOR SLOTTED HEAD SCREWS extra-long series



CODE	AxB mm	D1 x L1 mm	D2 x L2 mm	L/mm	Min. q.ty
FG 22/2.5x200	2.5x0.4	2.5x200	28.9x114	300	3pz
FG 22/2.5x300	2.5x0.4	3x300	28.9x100.9	400	3pz
FG 22/4x400	4.0x0.8	4x400	28.9x100.9	500	3pz
FG 22/5.5x400	7.5x1.0	5.5x400	28.9x100.9	514	3pz
FG 22/6.5x400	8.8x1.2	6.5x400	28.9x100.9	525	3pz

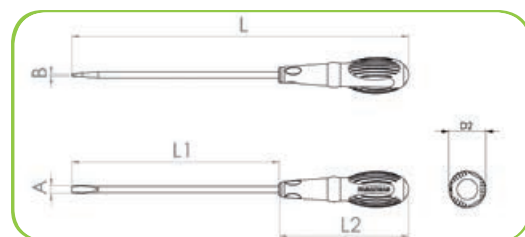

SCREWDRIVER FOR CROSS HEAD PH SCREWS extra-long series



CODE	PH	D1 x L1 mm	D2 x L2 mm	L/mm	Min. q.ty
FG 22/PH0x300	0	3x300	28.9x100	400	3pz
FG 22/PH1x400	1	5x400	32.7x114	514	3pz
FG 22/PH2x400	2	6x400	36.0x125	525	3pz

Set of extra-long screwdrivers for slotted and PH cross head screws



CODE	CONTENT
FG 22XL/S6	2.5x200, 4x400, 5.5x400, 6.5x400, PH0x300, PH1x400
FG 22XL/S8	2.5x200, 2.5x300, 4x400, 5.5x400, 6.5x400, PH0x300, PH1x400, PH2x400



Form of extra-long screwdrivers for slotted and PH cross head screws

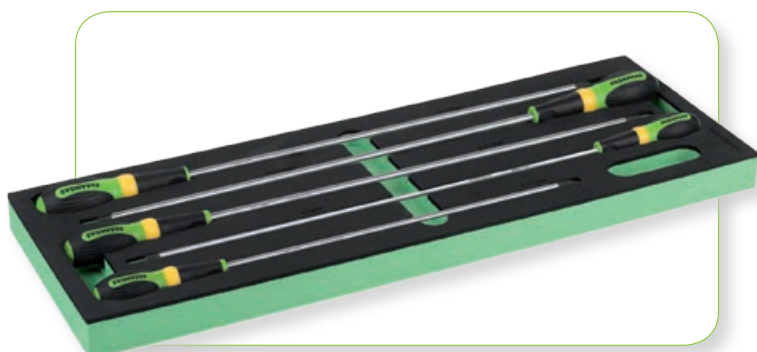

CODE	CONTENT
FG 100/45H	2.5x300, 4x400, 5.5x400, PH1x400, PH2x400



Offset screwdrivers

CODE	mm	L/mm	Minimum	
FG 22/OF4	4.0x4.0	100	03pz	
FG 22/OF5	5.5x5.5	125	03pz	
FG 22/OF8	8.0x8.0	150	03pz	

CODE	mm	L/mm	Minimum	
FG 22/PH12	PH1 - PH2	125	03pz	
FG 22/PH34	PH3 - PH4	200	03pz	



BALL HEAD HEXAGON DRIVERS WITH HANDLE

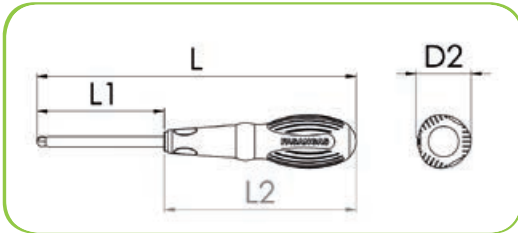

CODE	mm	D1 x L1 mm	D2 x L2 mm	L/mm	Minimum	
FG 22/H2	2	2.0x75	28.9x101	176	3pz	
FG 22/H2.5	2.5	2.5x75	28.9x101	176	3pz	
FG 22/H3	3	3x100	28.9x101	201	3pz	
FG 22/H4	4	4x100	28.9x101	201	3pz	
FG 22/H5	5	5.0x100	32.7x114	214	3pz	
FG 22/H6	6	6.0x125	36.0x125	250	2pz	
FG 22/H8	8	8.0x150	39.4x136.6	287	2pz	



Set of 7 ball head hexagon drivers with handles



CODE	CONTENT	
FG 22H/S7	2, 2.5, 3, 4, 5, 6, 8mm	

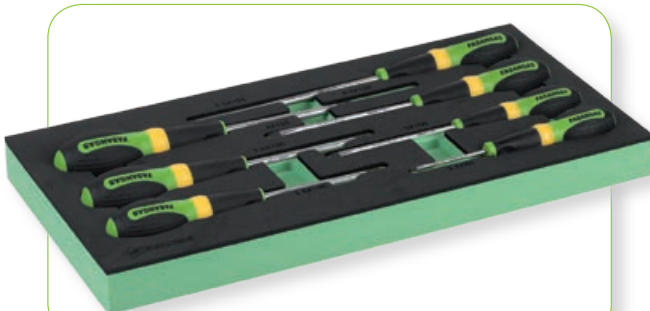

Soft form of 7 ball head hexagon drivers with handles



CODE	CONTENT	
FG 100/45M	2.5, 3, 4, 5, 6, 8mm	

SCREWDRIVER FOR TX HEAD SCREWS

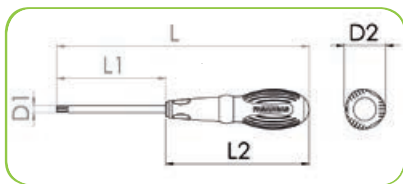

CODE	TX	D1 x L1 mm	D2 x L2 mm	L/mm	Minimum
FG 22/TX6	6	4.0x75	28.9x101	176	5pz
FG 22/TX7	7	4.0x75	28.9x101	176	5pz
FG 22/TX8	8	4.0x75	28.9x101	176	5pz
FG 22/TX9	9	4.0x75	28.9x101	176	5pz
FG 22/TX10	10	5.0x100	32.7x114	214	5pz
FG 22/TX15	15	5.0x100	32.7x114	214	5pz
FG 22/TX20	20	5.0x100	32.7x114	214	5pz
FG 22/TX25	25	6.0x100	36.0x125	225	5pz
FG 22/TX27	27	6.0x100	36.0x125	225	5pz
FG 22/TX30	30	6.0x100	36.0x125	225	5pz
FG 22/TX40	40	7.0x100	36.0x125	225	3pz
FG 22/TX45	45	8.0x100	39.4x136.6	237	3pz



Set of 6 screwdrivers for TX head screws

CODE	CONTENT
FG 22TX/S6	TX10, TX15, TX20, TX25, TX27, TX30

Set of screwdrivers for TX head screws

CODE	CONTENT
FG 22TX/S8	TX10, TX15, TX20, TX25, TX27, TX30, TX40, TX45
FG 22TX/S12	TX6, TX7, TX8, TX9, TX10, TX15, TX20, TX25, TX27, TX30, TX40, TX45



Soft form of 6 screwdrivers for TX head screws

CODE	CONTENT
FG 100/45I	TX10, TX15, TX20, TX25, TX27, TX30



Plastic tray of 6 screwdrivers for TX head screws

CODE	CONTENT
FG 102/45I	TX10, TX15, TX20, TX25, TX27, TX30



SCREWDRIVER FOR TX HEAD SCREWS WITH HOLE

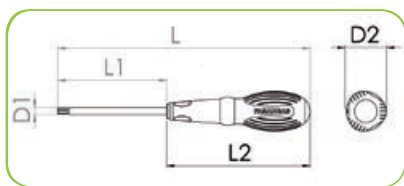

CODE	RTX	D1 x L1 mm	D2 x L2 mm	L/mm	Minimum
FG 22/RTX6	6	4.0x75	28.9x101	176	3pz
FG 22/RTX7	7	4.0x75	28.9x101	176	3pz
FG 22/RTX8	8	4.0x75	28.9x101	176	3pz
FG 22/RTX9	9	4.0x75	28.9x101	176	3pz
FG 22/RTX10	10	5.0x100	32.7x114	214	3pz
FG 22/RTX15	15	5.0x100	32.7x114	214	3pz
FG 22/RTX20	20	5.0x100	32.7x114	214	3pz
FG 22/RTX25	25	6.0x100	36.0x125	225	3pz
FG 22/RTX27	27	6.0x100	36.0x125	225	3pz
FG 22/RTX30	30	6.0x100	36.0x125	225	3pz
FG 22/RTX40	40	7.0x100	36.0x125	225	2pz
FG 22/RTX45	45	8.0x100	39.4x136.6	237	2pz



Set of 6 screwdrivers for TX head screws with hole

CODE	CONTENT
FG 22RTX/S6	RTX10, RTX15, RTX20, RTX25, RTX27, RTX30

Set of 6 screwdrivers for TX head screws with hole

CODE	CONTENT
FG 22RTX/S8	RTX10, RTX15, RTX20, RTX25, RTX27, RTX30, RTX40, RTX45
FG 22RTX/S12	RTX6, TX7, RTX8, RTX9, RTX10, RTX15, RTX20, RTX25, RTX27, RTX30, RTX40, RTX45



Soft form of 6 screwdrivers for TX head screws with hole

CODE	CONTENT
FG 100/45L	RTX10, RTX15, RTX20, RTX25, RTX27, RTX30



Plastic tray of 6 screwdrivers for TX head screws with hole

CODE	CONTENT
FG 102/45L	RTX10, RTX15, RTX20, RTX25, RTX27, RTX30

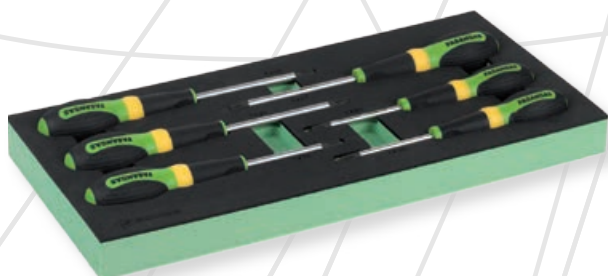

SCREWDRIVER FOR TX HEAD SCREWS extra-long series



CODE	TX	D1 x L1 mm	D2 x L2 mm	L/mm	Min. q.ty
FG 22XL/TX6	6	4.0x400	28.9x101	501	3pz
FG 22XL/TX7	7	4.0x400	28.9x101	501	3pz
FG 22XL/TX8	8	4.0x400	28.9x101	501	3pz
FG 22XL/TX9	9	4.0x400	28.9x101	501	3pz
FG 22XL/TX10	10	5.0x400	32.7x114	514	3pz
FG 22XL/TX15	15	5.0x400	32.7x114	514	3pz
FG 22XL/TX20	20	5.0x400	32.7x114	514	3pz
FG 22XL/TX25	25	6.0x400	36.0x125	525	3pz
FG 22XL/TX27	27	6.0x400	36.0x125	525	3pz
FG 22XL/TX30	30	6.0x400	36.0x125	525	3pz
FG 22XL/TX40	40	7.0x400	36.0x125	525	3pz

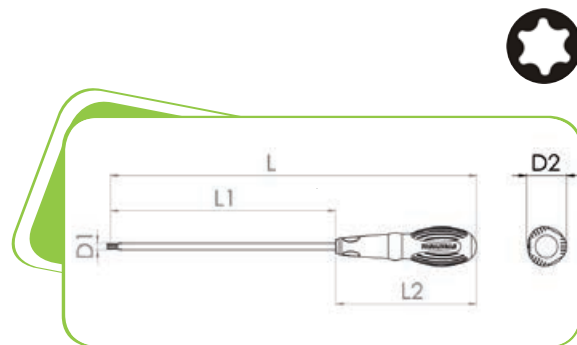

Set of extra-long screwdrivers for TX head screws

CODE	CONTENT
FG 22TX/LS8	TX8, 10, 15, 20, 25, 27, 30, 40
FG 22TX/LS11	TX6, 7, 8, 9, 10, 15, 20, 25, 27, 30, 40



FLEXIBLE HEXAGON NUT SPINNER WITH HANDLE - DIN 3125



CODE	mm	Ø1 x L1 mm	Ø2 x L2 mm	L/mm	Minimum
FG 22/FL5	5	6.0x150	36.0x125	275	5pz
FG 22/FL5.5	5.5	6.0x150	36.0x125	275	5pz
FG 22/FL6	6	6.0x150	36.0x125	275	5pz
FG 22/FL7	7	6.0x150	36.0x125	275	5pz
FG 22/FL8	8	6.0x150	36.0x125	275	3pz
FG 22/FL10	10	6.0x150	36.0x125	275	3pz

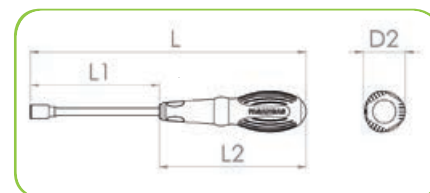

Set of 6 flexible hexagon nut spinners with handles

CODE	CONTENT
FG 22FL/S6	5, 5.5, 6, 7, 8, 10 mm

HEXAGON NUT SPINNER WITH HANDLE - DIN 3125



CODE	mm	Ø1 x L1 mm	Ø2 x L2 mm	L/mm	Minimum
FG 22/FX5	5	6.0x125	36.0x125	250	5pz
FG 22/FX5.5	5.5	6.0x125	36.0x125	250	5pz
FG 22/FX6	6	6.0x125	36.0x125	250	5pz
FG 22/FX7	7	6.0x125	36.0x125	250	5pz
FG 22/FX8	8	6.0x125	36.0x125	250	5pz
FG 22/FX9	9	6.0x125	36.0x125	250	5pz
FG 22/FX10	10	6.0x125	36.0x125	250	5pz
FG 22/FX11	11	6.0x125	36.0x125	250	3pz
FG 22/FX12	12	6.0x125	36.0x125	250	3pz
FG 22/FX13	13	6.0x125	36.0x125	250	3pz

NEW

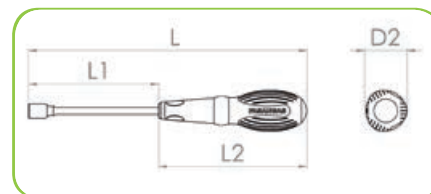

Set of hexagon nut spinners with handles

CODE	CONTENT
FG 22FX/S6	6, 7, 8, 9, 10, 12 mm
FG 22FX/S9B	5, 5.5, 7, 8, 9, 10, 12, 13 mm
FG 22FX/S10	5, 5.5, 6, 7, 8, 9, 10, 11, 12, 13 mm

NEW

NEW

Soft form of 5 hexagon nut spinners with handles

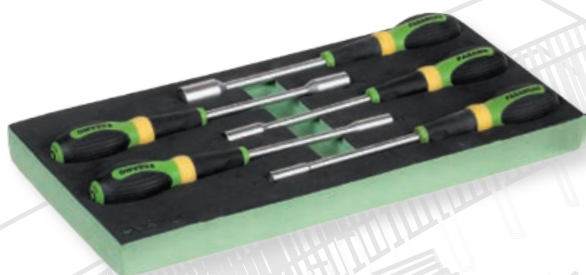

CODE	CONTENT
FG 100/45T	FX6, FX7, FX8, FX10, FX13

Plastic tray of 5 hexagon nut spinners with handles



CODE	CONTENT
FG 102/45T	FX6, FX7, FX8, FX10, FX13

Soft form of 8 hexagon nut spinners and flexible hexagon nut spinners with handles



CODE	CONTENT
FG 100/45N	FX6, FX7, FX8, FX10 FL6, FL7, FL8, FL10

OFFSET HEXAGON KEY WRENCH - short series



CODE	mm	L1/mm	L2/mm	Minimum q.ty
FG 139/B1.5	1.5	46.5	15.5	5pz
FG 139/B2	2.0	52.0	18.0	5pz
FG 139/B2.5	2.5	58.5	20.5	5pz
FG 139/B3	3.0	66.0	23.0	5pz
FG 139/B4	4.0	74.0	29.0	5pz
FG 139/B4.5	4.5	80.0	30.5	5pz
FG 139/B5	5.0	85.0	33.0	5pz
FG 139/B5.5	5.5	90.5	35.5	5pz
FG 139/B6	6.0	96.0	38.0	5pz
FG 139/B7	7.0	102.0	41.0	5pz
FG 139/B8	8.0	108.0	44.0	5pz
FG 139/B9	9.0	111.0	46.0	5pz
FG 139/B10	10.0	122.0	50.0	5pz

CODE	mm	L1/mm	L2/mm	Minimum q.ty
FG 139/B11	11.0	126.0	52.0	5pz
FG 139/B12	12.0	137.0	57.0	2pz
FG 139/B13	13.0	142.0	62.0	2pz
FG 139/B14	14.0	154.0	70.0	2pz
FG 139/B16	16.0	165.0	75.0	2pz
FG 139/B17	17.0	177.0	80.0	2pz
FG 139/B19	19.0	199.0	89.0	2pz
FG 139/B22	22.0	216.0	100.0	2pz
FG 139/B24	24.0	242.0	112.0	1pz
FG 139/B27	27.0	271.0	125.0	1pz
FG 139/B30	30.0	309.0	140.0	1pz
FG 139/B32	30.0	341.0	155	1pz
FG 139/B36	36.0	385.0	174.0	1pz

OFFSET HEXAGON KEY WRENCH - long series



CODE	mm	L1/mm	L2/mm	Minimum q.ty
FG 139/C1.5	1.5	63.5	15.5	5pz
FG 139/C2	2.0	77.0	18.0	5pz
FG 139/C2.5	2.5	87.5	20.5	5pz
FG 139/C3	3.0	93.0	23.0	5pz
FG 139/C4	4.0	104.0	29.0	5pz
FG 139/C4.5	4.5	114.5	30.5	5pz
FG 139/C5	5.0	120.0	33.0	5pz
FG 139/C5.5	5.5	134.0	35.5	5pz

CODE	mm	L1/mm	L2/mm	Minimum q.ty
FG 139/C6	6.0	141.0	38.0	5pz
FG 139/C7	7.0	147.0	41.0	5pz
FG 139/C8	8.0	158.0	44.0	5pz
FG 139/C10	10.0	180.0	50.0	5pz
FG 139/C12	12.0	202.0	57.00	2pz
FG 139/C14	14.0	229.0	70.0	2pz
FG 139/C17	17.0	262.0	80.0	2pz
FG 139/C19	19.0	289.0	89.0	2pz



Set of 9 offset hexagon key wrenches - short series

CODE	Pz	CONTENT
FG 139B/S6	06	2.5, 3, 4, 5, 6, 8mm

Set of 10 offset hexagon key wrenches - SHORT series

CODE	Pz	CONTENT
FG 139/B	10	1.5,2,2.5,3,4,5,6,8,10mm



Set of 10 offset hexagon key wrenches - LONG series

CODE	Pz	CONTENT
FG 139/C	10	1.5,2,2.5,3,4,5,6,8,10mm

OFFSET HEXAGON KEY WRENCH - short series

CODE	mm	L1/mm	L2/mm	Min. quantity
FG 139/1.5	1.5	77.0	14.0	5pz
FG 139/2	2.0	83.0	16.0	5pz
FG 139/2.5	2.5	90.0	18.0	5pz
FG 139/3	3.0	98.0	20.0	5pz
FG 139/4	4.0	106.0	24.0	5pz
FG 139/4.5	4.5	112.0	26.0	5pz
FG 139/5	5.0	118.0	28.0	5pz
FG 139/5.5	5.5	128.0	30.0	5pz
FG 139/6	6.0	137.0	32.0	5pz
FG 139/7	7.0	147.0	34.0	5pz
FG 139/8	8.0	156.0	36.0	5pz
FG 139/10	10.0	170.0	40.0	5pz

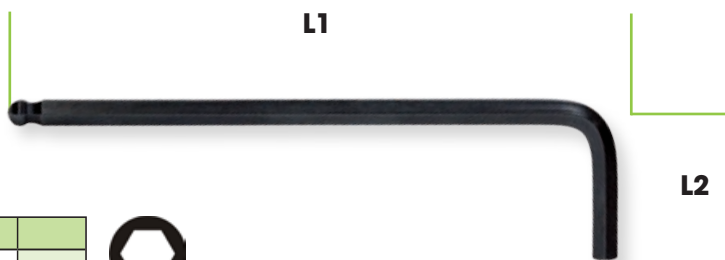

Set of 12 offset hexagon key wrenches

CODE	Pz	CONTENT
FG 139	12	1.5 - 10.0mm



Set of 9 offset hexagon key wrenches - short series

CODE	Pz	CONTENT
FG 139C/FS	9	1.5, 2, 2.5, 3, 4, 5, 6, 8mm

Set of 10 offset hexagon key wrenches - MAGNETIC series

CODE	Pz	CONTENT
FG 139/LM	10	1.5, 2, 2.5, 3, 4, 5, 6, 7, 8, 10mm

MAGNETIC TIP



OFFSET HEXAGON KEY WRENCH - long series



CODE	mm	L1/mm	L2/mm	Min. quantity
FG 139/L1.5	1.5	90.0	14.0	5pz
FG 139/L2	2.0	100.0	16.0	5pz
FG 139/L2.5	2.5	112.0	18.0	5pz
FG 139/L3	3.0	125.0	20.0	5pz
FG 139/L4	4.0	140.0	24.0	5pz
FG 139/L4.5	4.5	112.0	26.0	5pz
FG 139/L5	5.0	158.0	28.0	5pz
FG 139/L5.5	5.5	168.0	30.0	5pz

CODE	mm	L1/mm	L2/mm	Min. quantity
FG 139/L6	6.0	178.0	32.0	5pz
FG 139/L7	7.0	188.0	34.0	5pz
FG 139/L8	8.0	200.0	36.0	5pz
FG 139/L10	10.0	224.0	40.0	5pz
FG 139/L12	12.0	224.0	40.0	5pz
FG 139/L14	14.0	240.0	50.0	5pz
FG 139/L17	17.0	260.0	55.0	5pz
FG 139/L19	19.0	285.0	75.0	5pz



Set of 12 offset hexagon key wrenches - long series

CODE	Pz	CONTENT
FG 139/L	12	1.5 - 10.0mm

OFFSET HEXAGON KEY WRENCH - 110° series with extra short arm



CODE	mm	L1/mm	L2/mm	Minimum q.ty
FG 139/P1.5	1.5	68.0	8.0	5pz
FG 139/P2	2.0	78.0	8.0	5pz
FG 139/P2.5	2.5	89.0	9.0	5pz
FG 139/P3	3.0	95.0	9.0	5pz
FG 139/P4	4.0	105.0	12.0	5pz

CODE	mm	L1/mm	L2/mm	Minimum q.ty
FG 139/P5	5.0	105.0	12.0	5pz
FG 139/P6	5.5	123.0	12.0	5pz
FG 139/P8	6.0	144.0	15.0	5pz
FG 139/P10	7.0	185.0	22.0	5pz



Set of 09 offset hexagon key wrenches - 110° series with extra short arm

CODE	Pz	CONTENT
FG 139/S9	09	1.5 - 10 mm

OFFSET HEXAGON KEY WRENCH - inch series

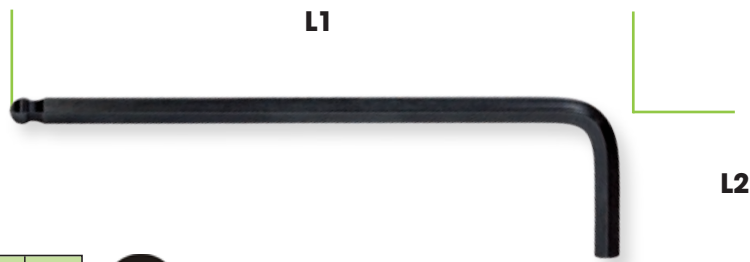

CODE	Inch	L1/mm	L2/mm	Minimum q.ty
FG 139IN0.05	0.05	72.0	12.0	5
FG 139IN1/6	1/6"	77.0	14.0	5
FG 139IN5/64	5/64"	82.0	15.0	5
FG 139IN3/32	3/32"	88.0	17.0	5
FG 139IN7/64	7/64"	92.0	18.0	5
FG 139IN1/8	1/8"	96.0	19.0	5
FG 139IN9/64	9/64"	101.0	20.0	5
FG 139IN5/32	5/32"	105.0	21.0	5
FG 139IN3/16	3/16"	114.0	24.0	5
FG 139IN7/32	7/32"	124.0	26.0	5
FG 139IN1/4	1/4"	135.0	28.0	5
FG 139IN5/16	5/16"	151.0	32.0	5
FG 139IN3/8	3/8"	170.0	35.0	5

Set of 13 offset hexagon key wrenches - inch series

CODE	Pz	CONTENT
FG 139/IN	13	0.05 - 3/8"



Set of 9 offset hexagon key wrenches - inch series

CODE	Pz	CONTENT
FG 139FS/IN	9	5/64, 3/32, 7/64, 1/8, 9/64, 5/32, 3/16, 7/32, 1/4"



Set of 12 offset hexagon key wrenches mm and inch series

CODE	CONTENT
FG 139/BK	1.5, 2, 2.5, 3, 4, 5, 6, 7, 8, 10mm 1/16, 5/64, 3/32, 1/8, 5/32, 3/16, 7/32, 1/4, 5/16, 3/8"



OFFSET TX KEY WRENCH - LONG SERIES

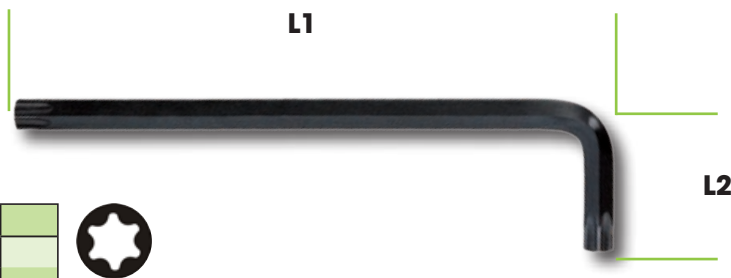

CODE	TX	L1/mm	L2/mm	Minimum q.ty	
FG 138/TX7	7	80.0	16.0	5pz	
FG 138/TX8	8	80.0	16.0	5pz	
FG 138/TX9	9	80.0	16.0	5pz	
FG 138/TX10	10	86.0	17.0	5pz	
FG 138/TX15	15	90.0	18.0	5pz	
FG 138/TX20	20	95.0	19.0	5pz	
FG 138/TX25	25	100.0	20.0	5pz	
FG 138/TX27	27	105.0	22.0	5pz	
FG 138/TX30	30	114.0	24.0	5pz	
FG 138/TX40	40	124.0	26.0	5pz	
FG 138/TX45	45.0	133.0	29.0	5pz	
FG 138/TX50	50	152.0	32.0	5pz	

Set of 12 TX offset key wrenches

CODE	Pz	CONTENT	
FG 138	12	TX7 - TX50	



Set of 8 TX offset key wrenches

CODE	Pz	CONTENT	
FG 138C/FS	8	TX9 -T40	

Set of 9 TX offset key wrenches

CODE	Pz	CONTENT	
FG 138/S9	09	TX8 - TX40	

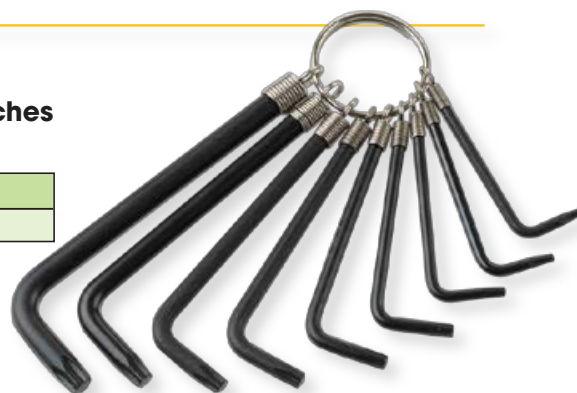

Set of 10 TX offset key wrenches

CODE	Pz	CONTENT	
FG 138/B	10	TX9 - TX50 - SHORT SERIES	
FG 138/C	10	TX9 - TX50 - LONG SERIES	



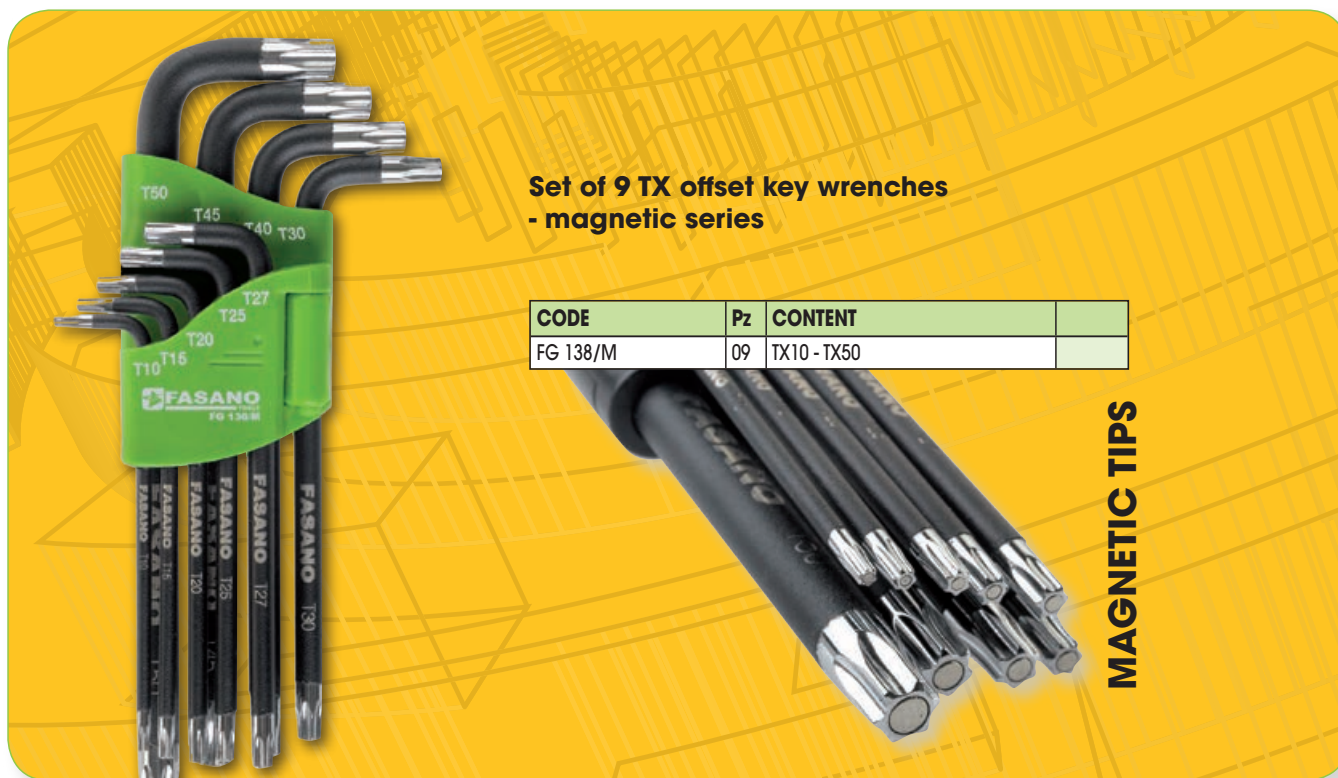

Set of 9 TX offset key wrenches
- magnetic series

CODE	Pz	CONTENT
FG 138/M	09	TX10 - TX50

MAGNETIC TIPS

OFFSET KEY WRENCH FOR TX HEAD SCREWS WITH HOLE

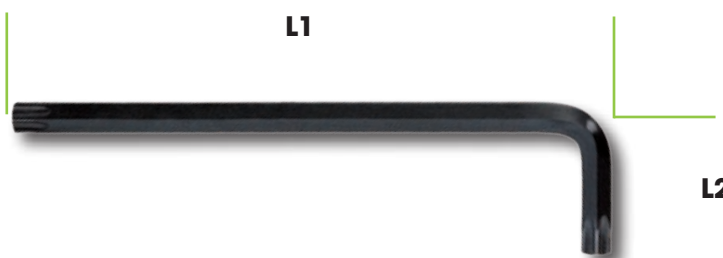

CODE	TX	L1/mm	L2/mm	Minimum q.ty
FG 137/TRX7	7	80.0	16.0	5pz
FG 137/TRX8	8	80.0	16.0	5pz
FG 137/TRX9	9	80.0	16.0	5pz
FG 137/TRX10	10	86.0	17.0	5pz
FG 137/TRX15	15	90.0	18.0	5pz
FG 137/TRX20	20	95.0	19.0	5pz
FG 137/TRX25	25	100.0	20.0	5pz
FG 137/TRX27	27	105.0	22.0	5pz
FG 137/TRX30	30	114.0	24.0	5pz
FG 137/TRX40	40	124.0	26.0	5pz
FG 137/TRX45	45	133.0	29.0	5pz
FG 137/TRX50	50	152.0	32.0	5pz

Set of 12 offset key wrenches for TRX head screws

CODE	Pz	CONTENT
FG 137	12	TRX7 - TRX50



OFFSET HEXAGON KEY WRENCH WITH BI-MATERIAL HANDLE

CODE	mm	AxB/mm	CxD/mm	
FG 142/2	2	85x133	13x96	
FG 142/2.5	2.5	95x143	13x96	
FG 142/3	3	107x155	13x96	
FG 142/4	4	113x167	17x109	
FG 142/5	5	124x178	17x109	
FG 142/6	6	127x192	23x130	
FG 142/7	7	132x197	23x130	
FG 142/8	8	137x202	23x130	
FG 142/10	10	147x212	23x130	

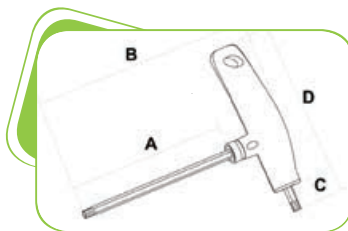

Set of offset hexagon key wrenches with bi-material handles

CODE	CONTENT	
FG 142/S8	2, 2.5, 3, 4, 5, 6, 8, 10 mm	

Set of offset hexagon key wrenches with bi-material handles

CODE	CONTENT	
FG 142/S5	2, 3, 4, 5, 6 mm	
FG 142/S9	2, 2.5, 3, 4, 5, 6, 7, 8, 10 mm	



Form of 9pcs offset hexagon key wrenches with bi-material handles + 12 offset TX key wrenches

CODE	CONTENT	
FG 100/50E	FG 142/2 - FG 142/10 FG 138/TX7 - FG 138/TX50	

Soft form of 6pcs offset hexagon key wrenches with bi-material handles

CODE	CONTENT	
FG 100/50F	FG 142/2, 2.5, 3, 4, 5, 6	



Plastic tray of 6pcs offset hexagon key wrenches with bi-material handles

CODE	CONTENT	
FG 102/50F	FG 142/2, 2.5, 3, 4, 5, 6	

OFFSET TX KEY WRENCH WITH BI-MATERIAL HANDLE

CODE	TX	AxB/mm	CxD/mm
FG 143/TX7	7	105x153	13x96
FG 143/TX8	8	105x153	13x96
FG 143/TX9	9	105x153	13x96
FG 143/TX10	10	105x153	13x96
FG 143/TX15	15	105x153	13x96
FG 143/TX20	20	112x166	17x109
FG 143/TX25	25	120x174	17x109
FG 143/TX27	27	120x174	17x109
FG 143/TX30	30	129x183	17x109
FG 143/TX40	40	131x196	23x130
FG 143/TX45	45	139x204	23x130
FG 143/TX50	50	139x204	23x130

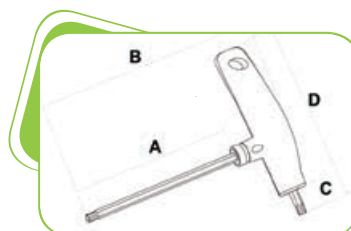

Set of offset TX key wrenches with bi-material handles

CODE	CONTENT
FG 143TX/S8	TX8, TX10, TX15, TX20, TX25, TX30, TX40, TX45

Set of offset TX key wrenches with bi-material handles

CODE	CONTENT
FG 143TX/S6	TX10, TX15, TX20, TX25, TX30, TX40
FG 143TX/S12	TX7, TX8, TX9, TX10, TX15, TX20, TX25, TX27, TX30, TX40, TX45, TX50



Soft form of 11 pcs offset TX key wrenches with bi-material handles

CODE	CONTENT
FG 100/50D	FG 143/TX7 - FG 143/TX45

Soft form of 06pcs offset TX key wrenches with bi-material handles

CODE	CONTENT
FG 100/50G	FG 143/TX10, TX15, TX20, TX25, TX27, TX30

Plastic tray of 06pcs offset TX key wrenches with bi-material handles

CODE	CONTENT
FG 102/50G	FG 143/TX10, TX15, TX20, TX25, TX27, TX30

1/4"dr. DRILL BIT FOR SLOTTED HEAD SCREWS DIN 3126 - C6.3

CODE	mm	L/mm	Minimum q.ty
FG 85/25F1	0.5x3	25	03pz
FG 85/25F2	0.6x4.5	25	03pz
FG 85/25F3	0.8x5.5	25	03pz
FG 85/25F4	1x5.5	25	03pz
FG 85/25F5	1.2x6.5	25	03pz
FG 85/25F6	1.2x8	25	03pz
FG 85/25F7	1.6x8	25	03pz



1/4"



1/4"dr. DRILL BIT FOR PH CROSS HEAD SCREWS DIN 3126 - C6.3

CODE	PH	L/mm	Minimum q.ty
FG 85/25PH0	0	25	03pz
FG 85/25PH1	1	25	03pz
FG 85/25PH2	2	25	03pz
FG 85/25PH3	3	25	03pz



1/4"



1/4"dr. DRILL BIT FOR PZ CROSS HEAD SCREWS DIN 3126 - C6.3

CODE	PZ	L/mm	Minimum q.ty
FG 85/25Z1	1	25	03pz
FG 85/25Z2	2	25	03pz
FG 85/25Z3	3	25	03pz
FG 85/25Z4	4	25	03pz



1/4"



Set of 6pcs PH and PZ 1/4" bits + 1/4"x1/4" bit holder

CODE	CONTENT
FG 85PHZ/S7	FG 85/25PH1,PH2,PH3, FG 85/25PZ1,PZ2,PZ3 - FG 88/60PI2



Set of 6pcs PH and SL 1/4" bits + 1/4"x1/4" bit holder

CODE	CONTENT
FG 85PHL/S7	FG 85/25PH1,PH2,PH3, FG 85/25F1, F3, F5 - FG 88/60PI2



Set of 10pcs PH and PZ 1/4" bits + 1/4"x1/4" bit holder

CODE	CONTENT
FG 85/S11	FG 85/25PH1,PH2,PH3, FG 85/25PZ1,PZ2,PZ3 FG 85/SL4, 5, 6, 7 - FG 88/60PI2



1/4"dr. DRILL BIT FOR HEXAGON HEAD SCREWS DIN 3126 - C6.3

CODE	mm	L/mm	Minimum q.ty
FG 85/25H1.5	1.5	25	03pz
FG 85/25H2	2	25	03pz
FG 85/25H2.5	2.5	25	03pz
FG 85/25H3	3	25	03pz
FG 85/25H4	4	25	03pz
FG 85/25H5	5	25	03pz
FG 85/25H6	6	25	03pz
FG 85/25H7	7	25	03pz
FG 85/25H8	8	25	03pz
FG 85/25H10	10	25	03pz



1/4"



1/4"dr. DRILL BIT FOR TX HEAD SCREWS DIN 3126 - C6.3

CODE	TX	L/mm	Minimum q.ty
FG 85/25T9	9	25	03pz
FG 85/25T10	10	25	03pz
FG 85/25T15	15	25	03pz
FG 85/25T20	20	25	03pz
FG 85/25T25	25	25	03pz
FG 85/25T27	27	25	03pz
FG 85/25T30	30	25	03pz
FG 85/25T40	40	25	03pz
FG 85/25T45	45	25	03pz
FG 85/25T50	50	25	03pz



1/4"



Set of 10pcs TX drill bits + 1/4"x1/4" bit holder

CODE	CONTENT
FG 85TX/S11	FG 85/25T7,T8,T9,T10, T15, T20, T25, T27,T30, T40 FG 89/60PI2 - biholder 1/4"x1/4"

1/4"



Set of 6pcs TX drill bits + 1/4"x1/4" bit holder



CODE	CONTENT
FG 85TX/S7	FG 85/25T10 T15, T20, T25, T30, T40 + biholder 1/4"x1/4"

Set of 6pcs TRX drill bits + 1/4"x1/4" bit holder



CODE	CONTENT
FG 85RTX/S7	TT10 TT15, TT20, TT25, TT30, TT40 + biholder 1/4"x1/4"



1/4"

1/4"dr. DRILL BIT FOR TRX HEAD SCREWS DIN 3126 - C6.3

CODE	TRX	L/mm	Minimum q.ty
FG 85/25TT10	10	25	03pz
FG 85/25TT15	15	25	03pz
FG 85/25TT20	20	25	03pz
FG 85/25TT25	25	25	03pz
FG 85/25TT27	27	25	03pz
FG 85/25TT30	30	25	03pz
FG 85/25TT40	40	25	03pz



1/4"



1/4"dr. DRILL BIT FOR XZN HEAD SCREWS DIN 3126 - C6.3

CODE	M	L/mm	Minimum q.ty
FG 85/25M4	4	25	03pz
FG 85/25M5	5	25	03pz
FG 85/25M6	6	25	03pz
FG 85/25M10	10	25	03pz



1/4"



1/4"

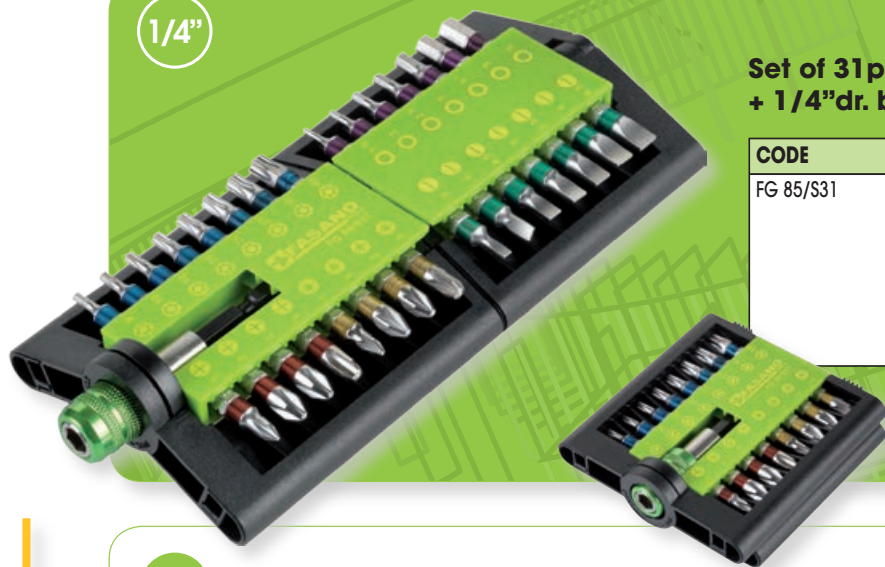

Set of 31 pcs 1/4"dr. bits, 25mm length + 1/4"dr. bit holder

CODE	CONTENT	
FG 85/S31	FG 88/PI14	
	FG 85/25PH1, PH2, PH3	⊕
	FG 85/25SL3, SL4, SL4.5, SL5, SL5.5, SL6, SL6.5	⊖
	FG 85/25PZ1, PZ2, PZ3	⊕
	FG 85/H1.5, H2, 2.5, H3, H4, H5, H6	○
	FG 85/25T9, T10, T15, T20, T25, T27, T30, T40	⊗

1/4"

Set of 40pcs 1/4"dr. bits, 25mm length

CODE	CONTENT	
FG 85/S40	FG 85/25F1, F2, F3, F4, F5, F6, F7	⊖
	FG 85/25PH0, PH1, PH2, PH3	⊕
	FG 85/25PZ1, Pz2, PZ3	⊕
	FG 85/H1.5, H2, H3, H4, H5, H6, H8, H10	○
	FG 85/25T10, T15, TT20, T25, T27, T30, T40	⊗
	FG 85/25TT10, TT15, TT20, TT25, TT27, TT30, TT40	⊗
	FG 85/25M4, M5, M6, M10	○



Set of 40pcs 1/4"dr. bits, 25mm length + 1/4"dr. ratchet handle and 1/4"x1/4"dr. adaptor

CODE	CONTENT	
FG 85/S42	FG 624/CR14 - ratchet handle 1/4"	
	FG 89/38/PI1 - bitholder 1/4"x1/4"	
	FG 85/25F1, F2, F3, F4, F5, F6, F7	⊖
	FG 85/25PH0, PH1, PH2, PH3	⊕
	FG 85/25PZ1, Pz2, PZ3	⊕
	FG 85/H1.5, H2, H3, H4, H5, H6, H8, H10	○
	FG 85/25T10, T15, TT20, T25, T27, T30, T40	⊗
	FG 85/25TT10, TT15, TT20, TT25, TT27, TT30, TT40	⊗
	FG 85/25M4, M5, M6, M10	○

1/4"

Set of 40pcs 1/4"dr. bits, 25mm length + 1/4"dr. ratchet handle and 1/4"x1/4"dr. adaptor

CODE	CONTENT	
FG 85/S42B	FG 624/CR14 - ratchet handle 1/4"	
	FG 89/38/PI1 - bitholder 1/4"x1/4"	
	FG 85/25F 1, F2, F3, F4, F5, F6, F7	⊖
	FG 85/25PH0, PH1, PH2, PH3	⊕
	FG 85/25PZ1, Pz2, PZ3	⊕
	FG 85/H1.5, H2, H3, H4, H5, H6, H8, H10	○
	FG 85/25T10, T15, TT20, T25, T27, T30, T40	⊗
	FG 85/25TT10, TT15, TT20, TT25, TT27, TT30, TT40	⊗
	FG 85/25M4, M5, M6, M10	○



Form of 40pcs 1/4"dr. bits, 25mm length + 1/4"dr. ratchet handle and 1/4"x1/4"dr. bits' adaptor

1/4"

CODE	CONTENT
FG 100/48B	FG 624/CR14 - ratchet handle 1/4"
	FG 89/38/PI1 - bitholder 1/4"x1/4"
	FG 85/25F1, F2, F3, F4, F5, F6, F7
	FG 85/25PH0, PH1, PH2, PH3
	FG 85/25PZ1, PZ2, PZ3
	FG 85/H1.5, H2, H3, H4, H5, H6, H8, H10
	FG 85/25T10, T15, TT20, T25, T27, T30, T40
	FG 85/25TT10, TT15, TT20, TT25, TT27, TT30, TT40
	FG 85/25M4, M5, M6, M10



Set of 40pcs 1/4"dr. bits, 25mm length + 1/4"dr. bit holder

1/4"

CODE	CONTENT
FG 85/S41	FG 88/PI14
	FG 85/25F1, F2, F3, F4, F5, F6, F7
	FG 85/25PH0, PH1, PH2, PH3
	FG 85/25PZ1, Pz2, PZ3
	FG 85/H1.5, H2, H3, H4, H5, H6, H8, H10
	FG 85/25T10, T15, TT20, T25, T27, T30, T40
	FG 85/25TT10, TT15, TT20, TT25, TT27, TT30, TT40
	FG 85/25M4, M5, M6, M10

Set of 40pcs 1/4"dr. bits, 25mm length + 1/4"dr. bit holder

1/4"

CODE	CONTENT
FG 85/S41B	FG 88/PI14
	FG 85/25F1, F2, F3, F4, F5, F6, F7
	FG 85/25PH0, PH1, PH2, PH3
	FG 85/25PZ1, Pz2, PZ3
	FG 85/H1.5, H2, H3, H4, H5, H6, H8, H10
	FG 85/25T10, T15, TT20, T25, T27, T30, T40
	FG 85/25TT10, TT15, TT20, TT25, TT27, TT30, TT40
	FG 85/25M4, M5, M6, M10



Form of 40pcs 1/4"dr. bits + bit holder

1/4"

CODE	
FG 100/48D	

CONTENT
FG 88/PI14
FG 85/25F1, F2, F3, F4, F5, F6, F7
FG 85/25PH0, PH1, PH2, PH3
FG 85/25PZ1, Pz2, PZ3
FG 85/H1.5, H2, H3, H4, H5, H6, H8, H10
FG 85/25T10, T15, TT20, T25, T27, T30, T40
FG 85/25TT10, TT15, TT20, TT25, TT27, TT30, TT40
FG 85/25M4, M5, M6, M10

Form of 40pcs 1/4"dr. bits + bit holder

CODE	
FG 102/48D	



1/4"dr. DRILL BIT FOR SLOTTED HEAD SCREWS

DIN 3126 - C6.3

1/4"

CODE	mm	L/mm	Minimum q.ty
FG 85/50F1	0.5x3	50	03pz
FG 85/50F2	0.6x4.5	50	03pz
FG 85/50F3	0.8x5.5	50	03pz
FG 85/50F4	1x5.5	50	03pz
FG 85/50F5	1.2x6.5	50	03pz
FG 85/50F6	1.2x8	50	03pz
FG 85/50F7	1.6x8	50	03pz



1/4"dr. DRILL BIT FOR PH CROSS HEAD SCREWS

DIN 3126 - C6.3

CODE	PH	L/mm	Minimum q.ty
FG 85/50PH1	1	50	03pz
FG 85/70PH1	1	70	03pz
FG 85/50PH2	2	50	03pz
FG 85/70PH2	2	70	03pz
FG 85/50PH3	3	50	03pz
FG 85/70PH3	3	70	03pz



1/4"dr. DRILL BIT FOR PZ CROSS HEAD SCREWS

DIN 3126 - C6.3

CODE	PZ	L/mm	Minimum q.ty
FG 85/50Z1	1	50	03pz
FG 85/50Z2	2	50	03pz
FG 85/50Z3	3	50	03pz



1/4"dr. DRILL BIT FOR HEXAGON CROSS HEAD SCREWS

DIN 3126 - C6.3

CODE	mm	L/mm	Minimum q.ty
FG 85/50H3	3	50	03pz
FG 85/50H4	4	50	03pz
FG 85/50H5	5	50	03pz
FG 85/50H6	6	50	03pz
FG 85/50H7	7	50	03pz
FG 85/50H8	8	50	03pz
FG 85/50H10	10	50	03pz



1/4"dr. DRILL BIT FOR TX HEAD SCREWS

DIN 3126 - C6.3

CODE	TX	L/mm	Minimum q.ty
FG 85/50T9	9	50	03pz
FG 85/50T10	10	50	03pz
FG 85/50T15	15	50	03pz
FG 85/50T20	20	50	03pz
FG 85/50T25	25	50	03pz
FG 85/50T27	27	50	03pz
FG 85/50T30	30	50	03pz
FG 85/50T40	40	50	03pz
FG 85/50T45	45	50	03pz
FG 85/50T50	50	50	03pz



1/4"dr. DRILL BIT FOR SLOTTED HEAD SCREWS

DIN 3126 - C6.3

CODE	mm	L/mm	Minimum q.ty
FG 85/100F3	0.6x3	100	03pz
FG 85/100F4	0.8x4	100	03pz
FG 85/100F5.5	1.0x5.5	100	03pz



1/4"

1/4"dr. DRILL BIT FOR PH CROSS HEAD SCREWS

DIN 3126 - C6.3

CODE	PH	L/mm	Minimum q.ty
FG 85/100PH1	1	100	03pz
FG 85/100PH2	2	100	03pz
FG 85/100PH3	3	100	03pz

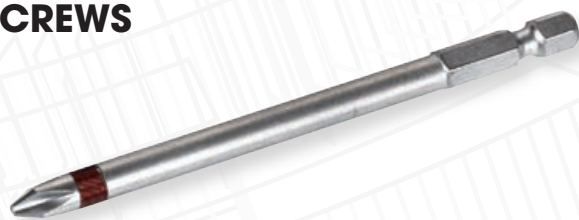

1/4"dr. DRILL BIT FOR PZ CROSS HEAD SCREWS

DIN 3126 - C6.3

CODE	PZ	L/mm	Minimum q.ty
FG 85/100PZ1	1	100	03pz
FG 85/100PZ2	2	100	03pz
FG 85/100PZ3	3	100	03pz



1/4"dr. DRILL BIT FOR HEXAGON CROSS HEAD SCREWS

DIN 3126 - C6.3

CODE	mm	L/mm	Minimum q.ty
FG 85/100H4	4	100	03pz
FG 85/100H5	5	100	03pz
FG 85/100H6	6	100	03pz



1/4"dr. DRILL BIT FOR TX HEAD SCREWS

DIN 3126 - C6.3

CODE	TX	L/mm	Minimum q.ty
FG 85/100T10	10	100	03pz
FG 85/100T15	15	100	03pz
FG 85/100T20	20	100	03pz
FG 85/100T25	25	100	03pz



Set of 15pcs 1/4"dr. bits, 25mm length

CODE	CONTENT
FG 85/S15L	FG 85/100F3, F4, F5.5
	FG 85/100PH0, PH1, PH2, PH3
	FG 85/100PZ1, Pz2, PZ3
	FG 85/100H4, H5, H6
	FG 85/100T15, T20, T25



BIT FOR PH CROSS HEAD SCREWS, 10mm drive DIN 3126 - C6.3



10mm



CODE	mm	L/mm	Minimum quantity
FG 86/30H4	4	30	03pz
FG 86/30H5	5	30	03pz
FG 86/30H6	6	30	03pz
FG 86/30H7	7	30	03pz
FG 86/30H8	8	30	03pz
FG 86/30H10	10	30	03pz
FG 86/30H12	12	30	03pz
FG 86/30H14	14	30	03pz

CODE	mm	L/mm	Minimum quantity
FG 86/75H4	4	75	03pz
FG 86/75H5	5	75	03pz
FG 86/75H6	6	75	03pz
FG 86/75H7	7	75	03pz
FG 86/75H8	8	75	03pz
FG 86/75H10	10	75	03pz
FG 86/75H12	12	75	03pz
FG 86/75H14	14	75	03pz

BIT FOR TX CROSS HEAD SCREWS, 10mm drive DIN 3126 - C6.3



10mm



CODE	TX	L/mm	Minimum quantity
FG 86/30T20	20	30	03pz
FG 86/30T25	25	30	03pz
FG 86/30T27	27	30	03pz
FG 86/30T30	30	30	03pz
FG 86/30T40	40	30	03pz
FG 86/30T45	45	30	03pz
FG 86/30T50	50	30	03pz
FG 86/30T55	55	30	03pz

CODE	TX	L/mm	Minimum quantity
FG 86/75T20	20	75	03pz
FG 86/75T25	25	75	03pz
FG 86/75T27	27	75	03pz
FG 86/75T30	30	75	03pz
FG 86/75T40	40	75	03pz
FG 86/75T45	45	75	03pz
FG 86/75T50	50	75	03pz
FG 86/75T55	55	75	03pz

BIT FOR RTX CROSS HEAD SCREWS, 10mm drive DIN 3126 - C6.3



10mm



CODE	TRX	L/mm	Minimum quantity
FG 86/30TT20	20	30	03pz
FG 86/30TT25	25	30	03pz
FG 86/30TT27	27	30	03pz
FG 86/30TT30	30	30	03pz
FG 86/30TT40	40	30	03pz
FG 86/30TT45	45	30	03pz
FG 86/30TT50	50	30	03pz
FG 86/30TT55	55	30	03pz

CODE	TRX	L/mm	Minimum quantity
FG 86/75TT20	20	75	03pz
FG 86/75TT25	25	75	03pz
FG 86/75TT27	27	75	03pz
FG 86/75TT30	30	75	03pz
FG 86/75TT40	40	75	03pz
FG 86/75TT45	45	75	03pz
FG 86/75TT50	50	75	03pz
FG 86/75TT55	55	75	03pz

BIT FOR XZN CROSS HEAD SCREWS, 10mm drive DIN 3126 - C6.3



10mm







CODE	M	L/mm	Minimum quantity
FG 86/30M5	5	30	03pz
FG 86/30M6	6	30	03pz
FG 86/30M8	8	30	03pz
FG 86/30M10	10	30	03pz
FG 86/30M12	12	30	03pz
FG 86/30M14	14	30	03pz

CODE	M	L/mm	Minimum quantity
FG 86/75M5	5	75	03pz
FG 86/75M6	6	75	03pz
FG 86/75M8	8	75	03pz
FG 86/75M10	10	75	03pz
FG 86/75M12	12	75	03pz



Set 52pcs drill bits with 10mm drive, 30mm and 75mm length

CODE	CONTENT
FG 86/S52	FG 86/30H4- H14, FG 86/75H4 - H14 
	FG 86/30T20 - T55, FG 86/75T20 - T55 
	FG 86/30TT20 - TT55, FG 86/75TT20- TT55 
	FG 86/30M5 - M14, FG 86/75M5- M12 

Soft form 52pcs drill bits with 10mmdrive, 30mm and 75mm length



CODE	CONTENT
FG 100/48G	52PZ

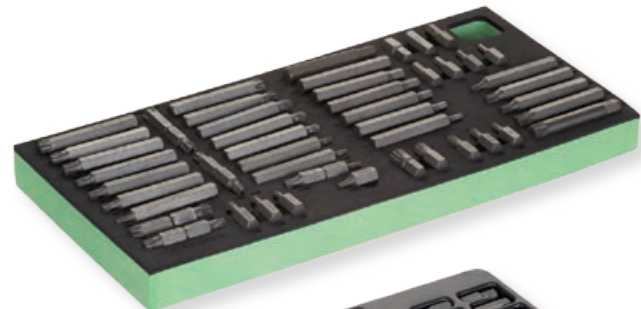



Plastic tray 52pcs drill bits with 10mmdrive, 30mm and 75mm length



CODE	CONTENT
FG 102/48G	52PZ





Set 28pcs drill bits with 10mmdrive, 30mm and 75mm length + adaptor

CODE	CONTENT
FG 86/S30B	FG 86/30T10- T40, FG 86/75T10 - T40 
	FG 86/30TT10- TT40, FG 86/75TT4 - TT40 
	ADATTATORE Bitholder 1/2" x 10mm



Set 28pcs drill bits with 10mmdrive, 30mm and 75mm length + 2 adaptors

CODE	CONTENT
FG 86/S30	FG 86/30T10- T40, FG 86/75T10 - T40 
	FG 86/30H4,5,6 - FG 86/75H4,5,6 
	FG 86/30M4-M10 - FG 86/75M4-M10 
	2 ADATTATORI Bitholder 1/2" x 10mm



5/16"dr. BIT FOR SLOTTED CROSS HEAD SCREWS

CODE	mm	L/mm	Minimum q.ty
FG 87/25F1	1.2x6.0	36	03pz
FG 87/25F2	1.6x8.0	36	03pz
FG 87/25F3	1.6x10	36	03pz
FG 87/25F4	2.0x12	36	03pz



5/16"



5/16"dr. BIT FOR PH CROSS HEAD SCREWS

CODE	PH	L/mm	Minimum q.ty
FG 87/PH1	1	36	03pz
FG 87/PH2	2	36	03pz
FG 87/PH3	3	36	03pz
FG 87/PH4	4	36	03pz



5/16"



5/16"dr. BIT FOR PZ CROSS HEAD SCREWS

CODE	PH	L/mm	Minimum q.ty
FG 87/PZ0	0	36	03pz
FG 87/PZ1	1	36	03pz
FG 87/PZ2	2	36	03pz
FG 87/PZ3	3	36	03pz



5/16"



5/16"dr. BIT FOR TX CROSS HEAD SCREWS

CODE	TX	L/mm	Minimum q.ty
FG 87/TX20	20	36	03pz
FG 87/TX25	25	36	03pz
FG 87/TX27	27	36	03pz
FG 87/TX30	30	36	03pz
FG 87/TX40	40	36	03pz
FG 87/TX45	45	36	03pz
FG 87/TX50	50	36	03pz



5/16"



5/16"dr. BIT FOR EXAGON CROSS HEAD SCREWS

CODE	mm	L/mm	Minimum q.ty
FG 87/H4	4	36	03pz
FG 87/H5	5	36	03pz
FG 87/H6	6	36	03pz
FG 87/H8	8	36	03pz
FG 87/H10	10	36	03pz



5/16"



IMPACT SCREWDRIVERS WITH GRIP HANDLE



CODE	Drive	L/mm	
FG 23/I	1/2"	145	

ADAPTOR FOR 5/16"dr. BITS

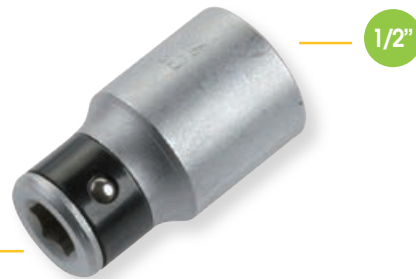

CODE	Drive	
FG 87/AD	1/2"	



Set of impact screwdrivers with 5/16"dr. adaptors and 25pcs 5/16"dr. impact bits

CODE	CONTENT	
FG 23/S28	FG 87/H4, H5, H6, H8, H10	
	FG 87/TX20, TX25, TX27, TX30, TX40, TX45, TX50, TX55	
	FG 87/PZ1, PZ2, PZ3, PZ4	
	FG 87/PH1, PH2, PH3, PH4	
	FG 87/F1, F2, F3, F4	



Form of impact screwdrivers with 5/16"dr. adaptors and 25pcs 5/16"dr. impact bits

CODE	CONTENT	
FG 100/45P	FG 87/H4, H5, H6, H8, H10	
	FG 87/TX20, TX25, TX27, TX30, TX40, TX45, TX50, TX55	
	FG 87/PZ1, PZ2, PZ3, PZ4	
	FG 87/PH1, PH2, PH3, PH4	
	FG 87/F1, F2, F3, F4	



BIT HOLDER FOR DRILL BITS

CODE	● x ◊	L/mm	
FG 88/60PI3	1/4" x 1/4"	60	



BIT HOLDER FOR DRILL BITS

CODE	● x ◊	L/mm	
FG 88/60PI1	1/4" x 1/4"	60	
FG 88/60PI2	1/4" x 1/4"	60	

N.B.:
 FG 88/60PI1 - without ring
 FG 88/60PI2 - with ring



1/4"dr. bit holder

CODE	L/mm	
FG 88/P14	258.0	



1/4"dr. bit holder with 1/4" drive

CODE	□ x ◊	L/mm	
FG 89/38PI1	1/4" x 1/4"	32	



1/4"dr. bit holder with 3/8" drive

CODE	□ x ◊	L/mm	
FG 89/50PI2	3/8" x 1/4"	50	
FG 89/50PI3	3/8" x 5/16"	50	



1/4"dr. bit holder with 1/2" drive

CODE	□ x ◊	L/mm	
FG 89/55PI4	1/2" x 1/4"	55	
FG 89/55PI5	1/2" x 5/16"	55	



1/4"dr. bit adaptor with SDS drive

CODE	⬡	L/mm	
FG 88/100SDS	1/4"	100	



1/4"dr. socket holder for drill

CODE	⬡ x ■	L/mm	
FG 88/75PB1	1/4" x 1/4"	75	



3/8"dr. socket holder for drill

CODE	⬡ x ■	L/mm	
FG 88/75PB2	1/4" x 3/8"	75	



1/2"dr. socket holder for drill

CODE	⬡ x ■	L/mm	
FG 88/75PB3	1/4" x 1/2"	75	

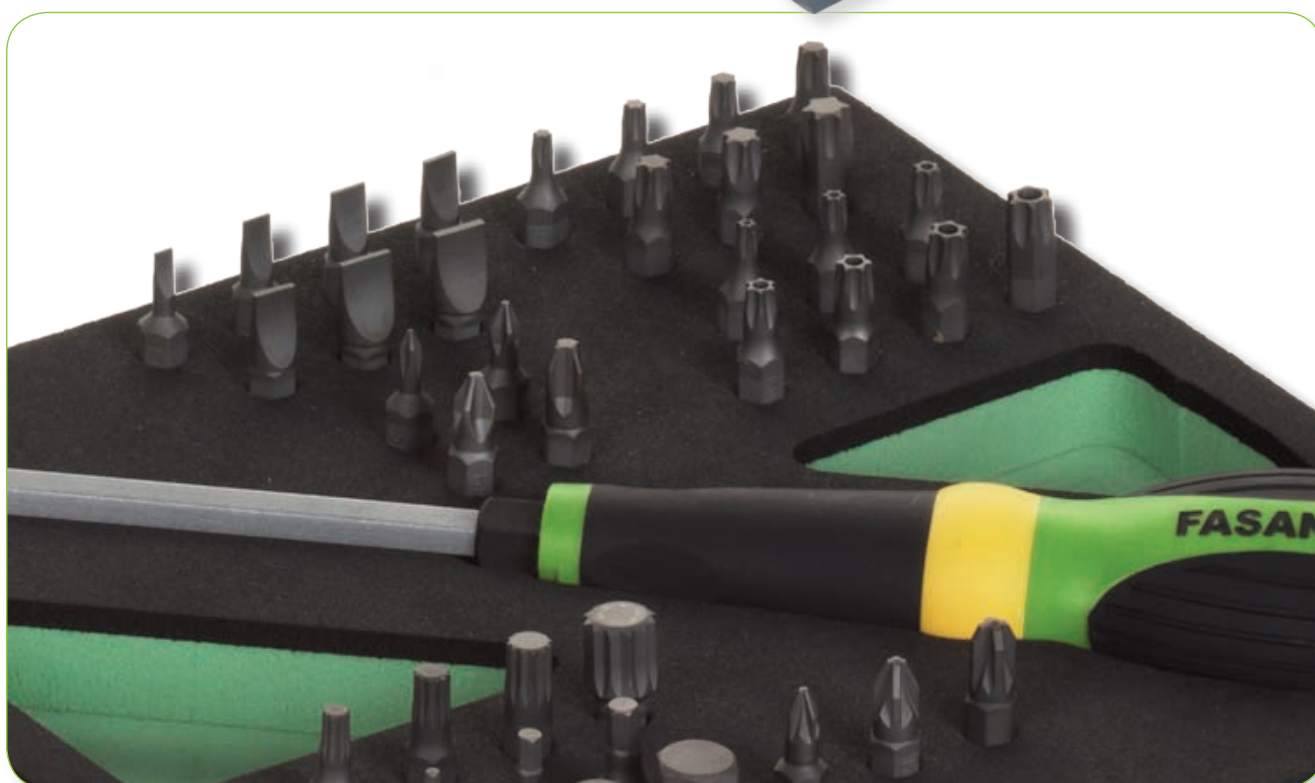

Combination pliers, Soft-Run system
- DIN ISO 5745

CODE	mm	Inch	
FG 59SR/160	160	6"	
FG 59SR/180	180	7"	
FG 59SR/200	200	8"	



Bent nose pliers, Soft-Run system
- DIN ISO 5745

CODE	mm	Inch	
FG 60SR/160	160	6"	
FG 60SR/200	200	8"	



Long nose pliers, Soft-Run system
- DIN ISO 5745

CODE	mm	Inch	
FG 61SR/160	160	6"	
FG 61SR/200	200	8"	



Flat nose pliers, Soft-Run system
- DIN ISO 5745

CODE	mm	Inch	
FG 62SR/160	160	6"	



Diagonal cutting pliers, Soft-Run system
- DIN ISO 5745

CODE	mm	Inch	
FG 63SR/160	160	6"	



Soft-run diagonal cutting pliers, Heavy-Duty model - DIN ISO 5745

CODE	mm	Inch	
FG 63SR/H180	180	7"	
FG 63SR/H200	200	8"	



Wire stripping pliers, Soft-Run system - DIN ISO 5745

CODE	mm	Inch	
FG 68SR/160	160	6"	



End cutting pliers, Soft-Run system - DIN ISO 5745

CODE	mm	Inch	
FG 64SR/220	220	9"	
FG 64SR/280	280	11"	



Set of 3pcs pliers

CODE	CONTENT	
FG 59SR/S3	FG 59SR/160, FG 61SR/160, FG 63SR/160	
FG 59SR/S3B	FG 59SR/180, FG 61SR/200, FG 63SR/H180	

Soft form of 3pcs pliers

CODE	Pz	CONTENT	
FG 100/39C	3	FG 59SR/180, FG 61SR/160, FG 63SR/160	

Plastic tray of 3pcs pliers

CODE	Pz	CONTENT	
FG 102/39C	3	FG 59SR/180, FG 61SR/160, FG 63SR/160	



Combination pliers, PVC handles

- DIN ISO 5745

CODE	mm	Inch	
FG 59PV/160	160	6"	
FG 59PV/180	180	7"	
FG 59PV/200	200	8"	



Bent nose pliers, PVC handles

- DIN ISO 5745

CODE	mm	Inch	
FG 60PV/160	160	6"	
FG 60PV/200	200	8"	



Long nose pliers, PVC handles

- DIN ISO 5745

CODE	mm	Inch	
FG 61PV/160	160	6"	
FG 61PV/200	200	8"	



Flat nose pliers, PVC handles

- DIN ISO 5745

CODE	mm	Inch	€/Pz
FG 62PV/160	160	6"	XXXX



Diagonal cutting pliers, PVC handles - DIN ISO 5745

CODE	mm	Inch	
FG 63PV/140	140	5"	
FG 63PV/160	160	6"	



PLIERS WITH PVC HANDLES

CODE	mm	Inch	
FG 63PV/H180	180	7"	
FG 63PV/H200	200	8"	



CODE	mm	Inch	
FG 64PV/160	140	5"	
FG 64PV/200	160	6"	



End cutting pliers, PVC handles - DIN ISO 5745

CODICE	mm	Inch	€/Pz
FG 65PV/220	220	8"	XXXX
FG 65PV/250	250	10"	XXXX
FG 65PV/280	280	11"	XXXX



Set of 3pcs pliers

CODE	CONTENT	
FG 59PV/S3	FG 59PV/160, FG 61PV/160, FG 63PV/160	
FG 59PV/S3B	FG 59PV/180, FG 61PV/180, FG 63PV/H180	

Plastic tray of 3pcs pliers

CODE	Pz	CONTENT	
FG 102/39D	3	FG 59PV/180, FG 61PV/160, FG 63PV/160	



Slip joint pliers boxed joints with push button alignment and slip-proof PVC handles

CODE	mm	Inch	n° positions
FG 58/A240	240	9.5"	5



Slip joint pliers boxed joints with slip-proof PVC handles
- DIN ISO 8976

CODE	mm	Inch	n° positions
FG 58/B180	180	7"	6
FG 58/B240	240	10"	7
FG 58/B300	300	12"	7
FG 58/400	400	16"	7



Set of 3pcs flexible pliers

CODE	CONTENT	mm
FG 515	Combination PINCES	180mm
	Diagonal cutting PINCES	160mm
	Long nose PINCES	160mm



Form of 3pcs flexible pliers

CODE	CONTENT	mm
FG 100/40B	Combination PINCES	180mm
	Diagonal cutting PINCES	160mm
	Long nose PINCES	160mm



Flat long nose pliers

CODE	mm	DEGREE	
FG 56/0	275	0°	
FG 57/0	400	0°	



45° Long nose pliers

CODE	mm	DEGREE	
FG 56/45	275	45°	
FG 57/45	400	0°	



90° Long nose pliers

CODE	mm	DEGREE	
FG 56/90	275	90°	
FG 57/90	400	0°	



Set of 3pcs long nose pliers

CODE	CONTENT	
FG 56/S3	FG 56/0, FG 56/45, FG 56/90	
FG 57/S3	FG 57/0, FG 57/45, FG 57/90	

Form of 7pcs pliers

CODE	CONTENT	DEGREE	
FG 100/43B	FG 56/0 e FG 57/0	0°	
	FG 56/45 e FG 57/45	45°	
	FG 56/90 e FG 57/90	90°	
	FG 58SR/250	-	



Circlip pliers for outside circlips

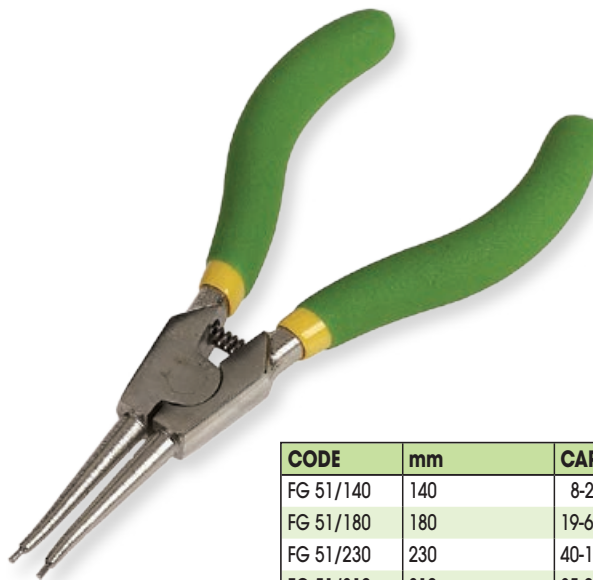

CODE	mm	CAPACITY	
FG 51/140	140	8-25mm	
FG 51/180	180	19-60mm	
FG 51/230	230	40-100mm	
FG 51/310	310	85-200mm	

Circlip pliers for 90° outside circlips



CODE	mm	CAPACITY	
FG 52/140	140	8-25mm	
FG 52/180	180	19-60mm	
FG 52/230	230	40-100mm	
FG 52/310	310	85-200mm	

Circlip pliers for inside circlips

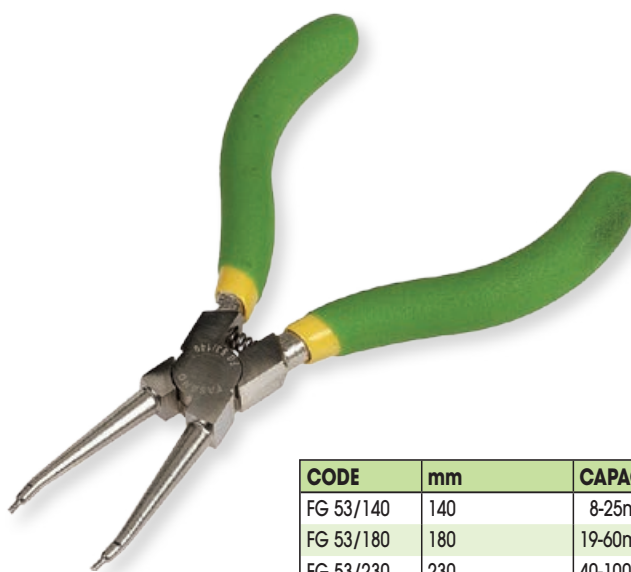

CODE	mm	CAPACITY	
FG 53/140	140	8-25mm	
FG 53/180	180	19-60mm	
FG 53/230	230	40-100mm	
FG 53/310	310	85-200mm	

Circlip pliers for 90° inside circlips

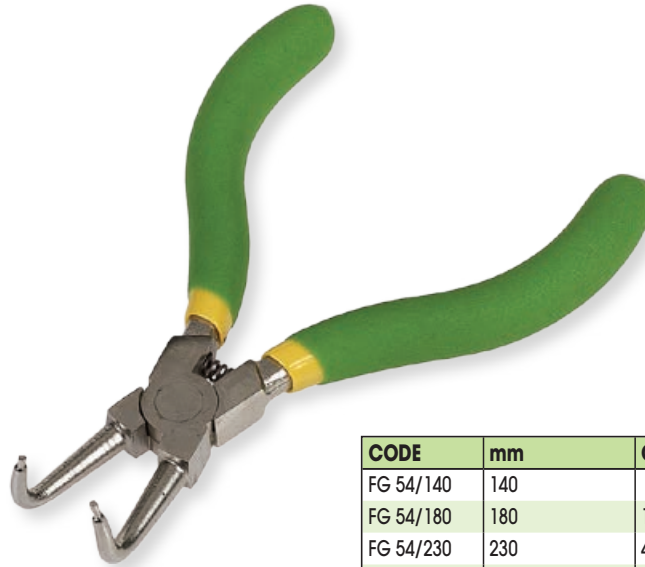

CODE	mm	CAPACITY	
FG 54/140	140	8-25mm	
FG 54/180	180	19-60mm	
FG 54/230	230	40-100mm	
FG 54/310	310	85-200mm	

Set of 4 circlip pliers

CODE	CONTENT	
FG 51/S4	FG 51/140, FG 52/140, FG 53/140, FG 54/140	
FG 51/S4B	FG 51/180, FG 52/180, FG 53/180, FG 54/180	



Soft form of 4 circlip pliers

CODE	CONTENU	
FG 100/41C	FG 51, FG 52, FG 53, FG 54/140	8-25mm
FG 100/42C	FG 51, FG 52, FG 53, FG 54/180	19-60mm

Plastic tray of 4 circlip pliers

CODE	CONTENU	
FG 102/41C	FG 51, FG 52, FG 53, FG 54/140	8-25mm
FG 102/42C	FG 51, FG 52, FG 53, FG 54/180	19-60mm

External butt-ended circlip pliers

CODE	L/mm	CAPACITY	
FG 55/SP	200	30 - 100	



Adjustable self-locking pliers, curve jaws

CODE	L/mm	Overfour max	
FG 69/CJ180	180	31mm	
FG 69/CJ250	250	37mm	

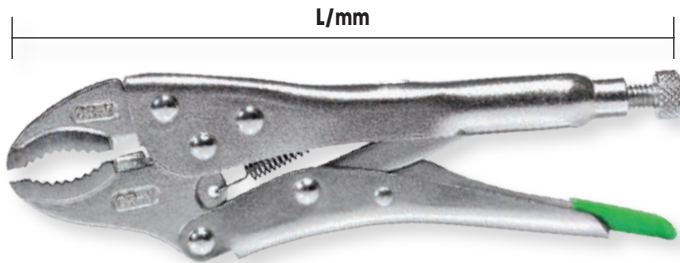

Adjustable self-locking pliers, curve jaws

CODE	L/mm	Max opening	
FG 70/CJ140	140	30mm	
FG 70/CJ180	180	35mm	
FG 70/CJ250	250	50mm	
FG 70/CJ300	300	65mm	

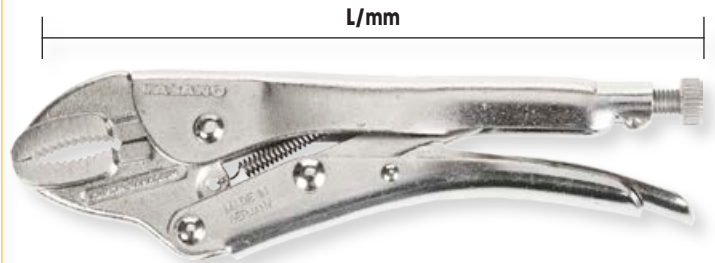

Superior line

Adjustable self-locking pliers, straight jaws

CODE	L/mm	Max opening	
FG 69/LN170	170	38mm	
FG 69/LN230	230	65mm	

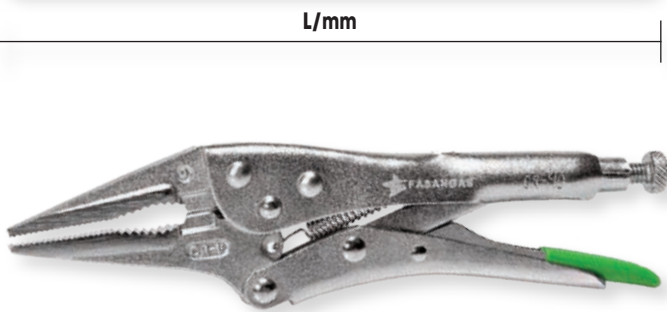

Adjustable self-locking pliers, straight jaws

CODE	L/mm	Max opening	
FG 70/LN165	165	40mm	
FG 70/LN240	240	55mm	



Superior line

Adjustable self-locking pliers, C-shaped jaws

CODE	L/mm	Max opening	
FG 69/CC170	170	43mm	
FG 69/CC280	280	64mm	



Adjustable self-locking pliers, C-shaped jaws

CODE	L/mm	Max opening	
FG 70/CC175	175	50mm	
FG 70/CC280	280	90mm	

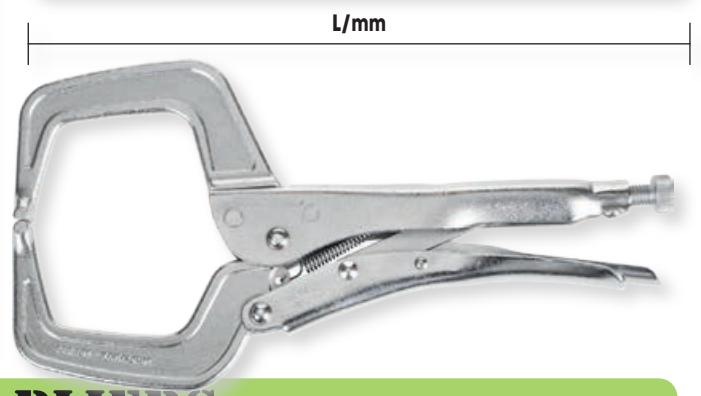

Superior line

SELF-LOCKING PLIERS

Adjustable self-locking pliers, C-shaped floating jaws

CODE	L/mm	Max opening	
FG 69/CP170	170	45mm	
FG 69/CP280	280	73mm	

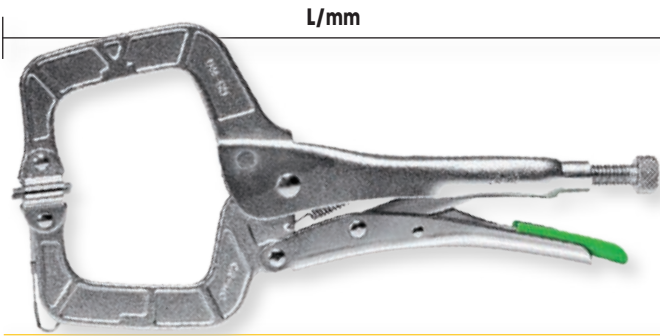

Adjustable self-locking pliers, C-shaped floating jaws

CODE	L/mm	Max opening	
FG 70/CP175	175	40mm	
FG 70/CP280	280	90mm	

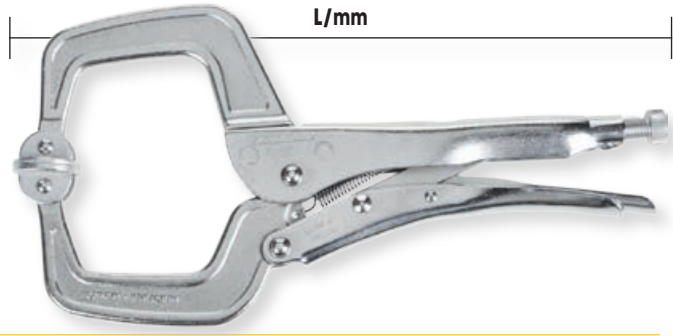

Superior line

Adjustable self-locking pliers, flat jaws

CODE	L/mm	Max opening	
FG 69/CS200	200	25mm	

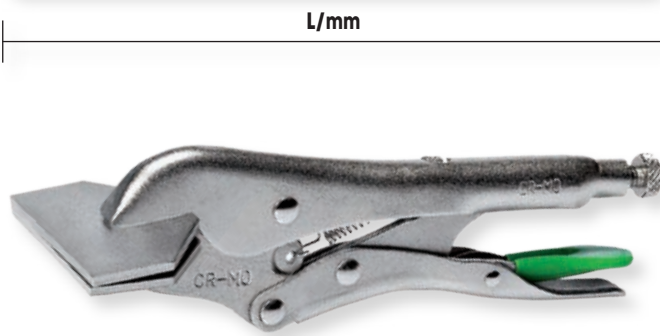

Adjustable self-locking pliers, fork type jaws

CODE	L/mm	Max opening	
FG 69/CW225	225	25mm	

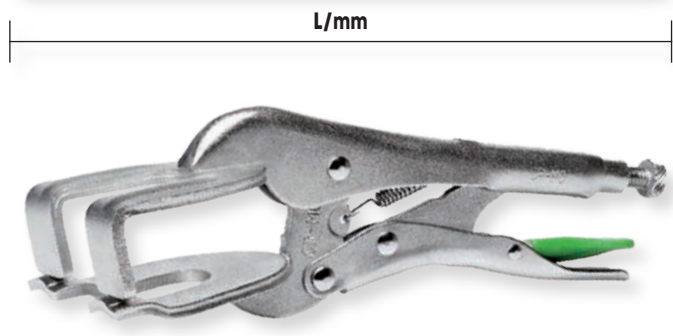

Adjustable self-locking pliers, PARROT model

CODE	L/mm	Max opening	
FG 69/PP215	215	38mm	



Adjustable self-locking pliers with chain

CODE	L/mm	∅/mm	
FG 69/CH130	250	75mm	

