

IMPACT WRENCHES



Impact wrenches - 1/2"	212
Impact wrenches - 3/8"	216
Impact wrenches - 3/4"	215
Impact wrenches - 1"	215

SAWS, DRILLS AND RIVETERS



Air saw	218
Air drills	218
Air riveters	219

AIR RATCHET WRENCHES



Air ratchet wrench - 1/4"	216
Air ratchet wrench - 3/8"	217
Air ratchet wrench - 1/2"	217

GRINDERS AND SANDERS



Die grinders	220
Roto-orbital sander	223
Multi-function sander	223

10



VARIOUS



Air hammer	217
Washing guns	221
Blowing guns	222
Tyre inflating gun	222

SPARE PARTS

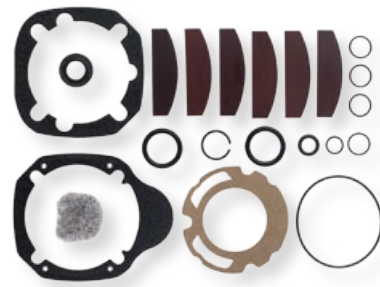

Spare parts	228
-------------	-----

AIR HOSES, FILTERS AND ADAPTORS



Air hoses	225
Air filters regulators / lubricators	225
Adaptors	226
Quick couplings	226



PNEUMATIC TOOLS

This section dedicated to pneumatic tools continues its development with introduction of new models both for the Automotive and Industry sectors.

Impact wrenches with more torque and with a revised and more eye-catching design, coupled with the new line of pneumatic grinders for the industrial sector, make this section more and more a strength of the FASANO TOOLS range.



Max Torque



Jumbo Hammer

Impact wrench-1/2"

 1.200	 (746) Nm	 (610) Nm
 136 L/min	 9.500 RPM	 6:2 Bar

CODE	
FGA 307	









Max Torque



Twin Hammer

Impact wrench-1/2"

 1.900	 (1.085) Nm	 (746) Nm
 151 L/min	 7.300 RPM	 6:2 Bar

CODE	
FGA 309	



IMPACT WRENCHES

NEW



**Max
Torque**



**Twin
Hammer**

Impact wrench-1/2"



CODE	
FGA 312	



NEW

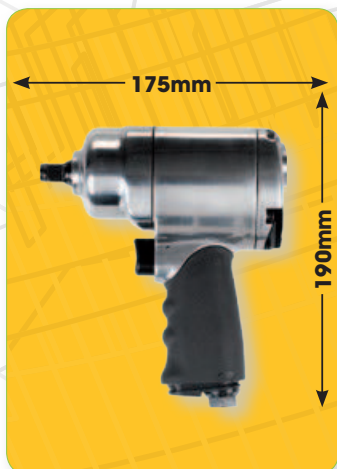

**Twin
Hammer**

Impact wrench-1/2"



CODE	
FGA 302	



184mm



**Twin
Hammer**

Impact wrench- 1/2"



CODE	
FGA 303	





**Set of 1/2"dr. impact wrench FGA 302
+ 3pcs 1/2"dr. impact sockets**

CODE	CONTENUTO	
FGA 302/S4	FGA 302 FG 628/R17, 19, 21	

CE



**Set of 1/2"dr. impact wrench FGA 302
+ 10pcs 1/2"dr. impact sockets**

CODE	CONTENUTO	
FGA 302/S10	FGA 302 FG 628/C10,11,13,14,17,19,22,24,27	

NEW



**Set of 1/2"dr. impact wrench FGA 303
+ 3pcs 1/2"dr. impact sockets**

CODE	CONTENUTO	
FGA 303/S4	FGA 303 FG 628/R17, 19, 21	

CE



**Set of 1/2"dr. impact wrench FGA 303
+ 10pcs 1/2"dr. impact sockets**

CODE	CONTENUTO	
FGA 303/S10	FGA 303 FG 628/C10,11,13,14,17,19,22,24,27	



**Set of 1/2"dr. impact wrench FGA 309
+ 3pcs 1/2"dr. impact sockets**

CODE	CONTENUTO	
FGA 309/S4	FGA 309 FG 628/R17, 19, 21	

CE



**Set of 1/2"dr. impact wrench FGA 309
+ 10pcs 1/2"dr. impact sockets**

CODE	CONTENUTO	
FGA 309/S10	FGA 309 FG 628/C10,11,13,14,17,19,22,24,27	

NEW

IMPACT WRENCHES

NEW



Max Torque



Twin Hammer

3/4"dr. air impact wrenches

3.300	1.898 Nm	1.627 Nm
229 L/min	5.300 RPM	6.2 Bar



CODE	
FGA 316	



Twin hammer



1"dr. air impact wrenches

10.200	2.700 Nm	2.500 Nm
271 L/min	4.800 RPM	6.2 Bar

CODE	
FGA 319	



Twin Hammer

1"dr. air impact wrenches



CODE	
FGA 321	

2.576 Nm	5.500 RPM
----------	-----------

340 L/min	1/2" 13mm
-----------	-----------

6.800	6.2 Bar
-------	---------

2.983 Nm

1"dr. air impact wrenches - 6" anvil



CODE	
FGA 321/B	



3/8"dr. air impact wrench



Twin hammer

1.280	(475) Nm	(441) Nm
130 L/min	9.000 RPM	6.2 Bar

CODE	
FGA 304	



CE

1/4"dr. air ratchet wrench

40 Nm	280 RPM	630
68 L/min	3/8" 10mm	6.2 Bar

CE

CODE	
FGA 290	



1/4"dr. air ratchet wrench

27 Nm	240 RPM	0.430
85 L/min	1/4" 10mm	6.2 Bar

CE

CODE	
FGA 291/B	



1/4"dr. air ratchet wrench

27 Nm	240 RPM	0.430
85 L/min	1/4" 10mm	6.2 Bar

CE

CODE	
FGA 291/C	



AIR RATCHET WRENCH

3/8"dr. air ratchet wrench

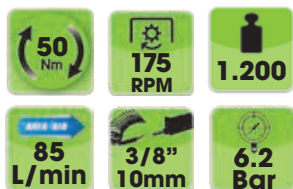

CODE	
FGA 291	



1/2"dr. air ratchet wrench



Working
Torque

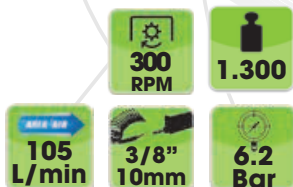

CODE	
FGA 292/B	

NEW



Tyre inflating gun

- Aluminum nickel-plated body
- Anti-oil rubber casing
- Gauge Ø80 (0-10bar / 0-140 PSI)
- Protected against pressure fluctuation
- 2 positions inflate/deflate lever
- Tube lenght: 500mm



CODE	
FGA 390	

CEE approved



Air saw

9.500 min	3m/s²	400
99 L/min	3/8" 10mm	6.2 Bar

CODE	
FGA 330	

BLADES:

CODE	Min. q.ty	
FGA 330/24T	10pz	
FGA 330/32T	10pz	



Angle air drill keyless chuck 1-10mm

0.45 Hp	1.800 RPM	1.100
60 L/min	3/8" 10mm	6.2 Bar

CODE	
FGA 332/AN	



Reversible air drill keyless chuck 1-10mm

0.45 Hp	1.800 RPM	900
102 L/min	3/8" 10mm	6.2 Bar

CODE	
FGA 332	



Reversible air drill keyless chuck 1-13mm

0.45 Hp	700 RPM	1.300
113 L/min	3/8" 10mm	6.2 Bar

CODE	
FGA 333	



AIR RIVETERS AND ANGLE GRINDERS

CE

Air riveter
- 4 interchangeable heads

POWER
8.000
N

CORSA
14mm

1.500

113
L/min

3/8"
10mm

6.2
Bar

CODE	
FGA 335	

Ø/mm	2.4	3.2	4.0	4.8
Aluminum	X	X	X	X
Steel	X	X	X	X
INOX	X	X	X	



CE

Air riveter
- 4 interchangeable heads

POWER
13.930
N

STROKE
18mm

2.000

148
L/min

3/8"
10mm

6.2
Bar

CODE	
FGA 336	

Ø/mm	3.0/3.2	4.0	4.8	6.4
Aluminum	X	X	X	X
Steel	X	X	X	X
INOX	X	X	X	



Angle grinder
- Ø grinding disc: 50mm

15.000
RPM

0.5

74
L/min

3/8"
10mm

6.2
Bar

CE

CODE	
FGA 339/B	



Angle grinder
- Ø grinding disc: 115mm

M
14x2

11.000
RPM

2.000

100
L/min

3/8"
10mm

6.2
Bar

CE

CODE	
FGA 339	



Die grinder

NEW

(0.35) Hp	30.000 RPM	600
73 L/min	3/8" 10mm	6.2 Bar

CE

CODE	
FGA 334	



Angle die grinder - 115°

NEW

(0.35) Hp	25.000 RPM	600
73 L/min	3/8" 10mm	6.2 Bar

CE

CODE	
FGA 334/AN115	



Long extension die grinder

NEW

(0.35) Hp	27.000 RPM	800
73 L/min	3/8" 10mm	6.2 Bar

CE

CODE	
FGA 334/L	



Angle die grinder

NEW





(0.35) Hp	22.000 RPM	700
60 L/min	3/8" 10mm	6.2 Bar

CE

CODE	
FGA 334/AN	



Air eraser





 60 L/min	 2.600 RPM	 1.800
 3/8" 10mm	 6:2 Bar	

CODE	
FGA 337	



FGA 337/R1
Rubber disc (thread: 5/16"-24UNF)

Air tire buffer

 99 L/min	 2.600 RPM	 1.800
 3/8" 10mm	 6:2 Bar	

CODE	
FGA 322	



Buffer replacement:
FGA 322/R2

Rando orbital sander - \varnothing orbital: 2mm

 45 L/min	 13.000 RPM	 500
 3/8" 10mm	 6:2 Bar	



CODE	
FGA 342	



Discs for FGA 342
- Quantity per set: 50pcs

CODE	GRANA	\varnothing /mm	
FGA 342/R120	120	32	
FGA 342/R180	180	32	
FGA 342/R320	320	32	
FGA 342/RT120	120	50	
FGA 342/RT180	180	50	
FGA 342/RT320	320	50	

NEW

CODE	GRANA	
FGA 342/T120	120	
FGA 342/T180	180	
FGA 342/T320	320	



Roto-orbital sander - \varnothing orbital: 5mm





 152mm	 11.000 RPM	 900
 45.6 L/min	 3/8" 10mm	 6.2 Bar



CODE	
FGA 340	



Multi-function sander

 4.000 RPM	 1.200
 60 L/min	 3/8" 10mm
 6.2 Bar	



CODE	
FGA 341	

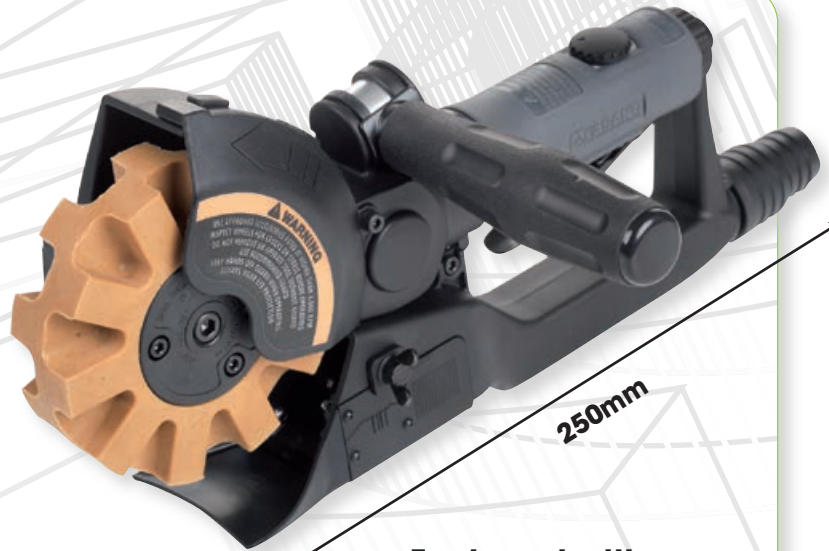

250mm

Equipped with
central vacuum

Supplied in ABS
case, with
accessories



CODE	\varnothing /mm	
FGA 341/R1	110	

CODE	\varnothing /mm	
FGA 341/R3	110	



CODE	\varnothing /mm	
FGA 341/R2	65	

CODE	\varnothing /mm	
FGA 341/R4	110 / 0.5	
FGA 341/R5	110 / 0.5	
FGA 341/R4	110 / 0.7	





AIR HAMMER KIT with 5 chisels

- Chisel inlet: 11mm
- Piston size: 19mm
- Colpi al minuto: 2.000
- Air consumption: 78.4 L/min - 2,78CFM
- Inlet: 10mm - 3/8"
- Weight: 1.94Kg

CODE	
FGA 345	



Spring for FGA 345

CODE	
FGA 345/M	



Chisels for air hammer

CODE	L/mm	Drive/mm	
FGA 345/S1	175	11	
FGA 345/S2	175	11	
FGA 345/S3	175	11	
FGA 345/S4	175	11	
FGA 345/S5	175	11	



Needle scraper for FGA 345

CODE	
FGA 345/SC	100,00

Washing gun

- Aluminum nickel-plated body
- Capacity: 1Litro
- **Stell suction pipe**
- Air flow regulator
- Product flow regulator
- Pattern regulation nozzle
- 1/4" BSP thread



CODE	
FGA 380	





Flexible PVC air hose with coupling and adaptor

CODE	Lenght	Ø/mm	Ø GAS
FGA 382/B10	10mt.	8x12	1/4"
FGA 382/B15	15mt.	8x12	1/4"
FGA 382/B20	20mt.	8x12	1/4"
FGA 384/B15	15mt.	10x15	3/8"



Extendible polyurethane net reinforced air hose with coupling and adaptor

CODE	Lenght	Ø/mm	Ø GAS
FGA 383	9mt.	8x12	1/4"
FGA 383/2	12mt.	8x12	1/4"
FGA 383/3	9mt.	11x16	3/8"

CODE	Ø/mm	Ø GAS
FGA 384/R1	8x12	1/4"
FGA 384/R2	11X16	1/4"



Air blow gun

- Progressive air jet
- Copper inside thread

CODE
FGA 416



Air blow gun

- Progressive air jet
- Aluminum nickel-plated body
- Rubber grip handle

CODE
FGA 419



Air blow gun

CODE	L/mm
FGA 418/A	110

CODE	L/mm
FGA 418/B	288



Air filter regulator lubricator

- Max air flow: 4.000 l/min
- Working pressure: 1.5-9.0BAR/21-128PSI
- Working temperature: 5-60°
- Oil bowl capacity: 75cc
- Air bowl capacity: 40cc
- Weight: 980gr.

CODE	INLET
FGA 385	1/4"

CODE	INLET
FGA 386	3/8"

CODE	INLET
FGA 387	1/2"





CODE	AIR OUTLET	BSP THREAD	
FGA 381/1	6mm	1/4"	
FGA 381/2	6mm	3/8"	
FGA 381/3	6mm	1/2"	

CODE	AIR OUTLET	BSP THREAD	
FGA 381/4	6mm	1/4"	
FGA 381/5	6mm	3/8"	

CODE	OUTLET	
FGA 381/6	6mm	
FGA 381/7	8mm	

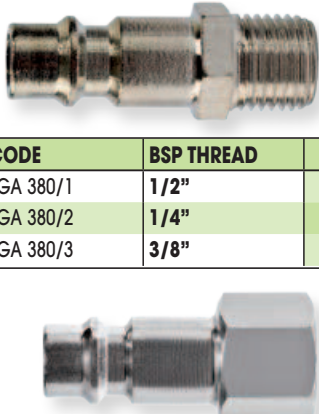

CODE	BSP THREAD	
FGA 380/1	1/2"	
FGA 380/2	1/4"	
FGA 380/3	3/8"	

CODE	BSP THREAD	
FGA 380/4	1/2"	
FGA 380/5	1/4"	
FGA 380/6	3/8"	

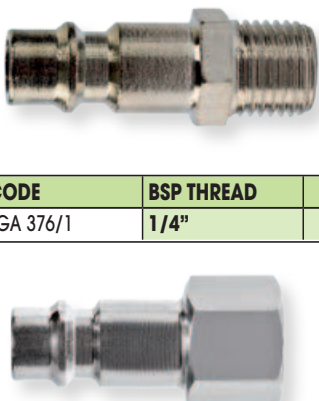

CODE	BSP THREAD	
FGA 376/1	1/4"	

CODE	BSP THREAD	
FGA 376/2	1/4"	



CODE	AIR OUTLET	BSP THREAD	
FGA 377/1	6mm	1/4"	

CODE	AIR OUTLET	BSP THREAD	
FGA 377/2	6mm	1/4"	

CODE	OUTLET	
FGA 377/3	6mm	



CODE	AIR OUTLET	BSP THREAD	
FGA 379/1	8mm	3/8"	

CODE	AIR OUTLET	BSP THREAD	
FGA 379/2	8mm	3/8"	

CODE	OUTLET	
FGA 379/3	8mm	

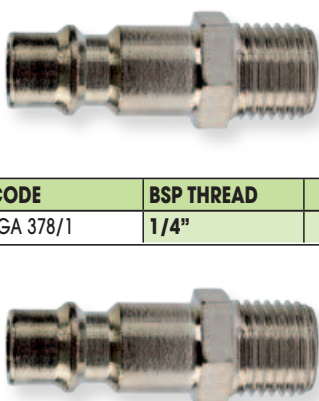

CODE	BSP THREAD	
FGA 378/1	1/4"	

CODE	BSP THREAD	
FGA 378/2	3/8"	

QUICK COUPLINGS AND ADAPTORS

JAPAN STYLE



CODE	AIR OUTLET	BSP THREAD	
FGA 381/1N	6mm	1/4"	
FGA 381/2N	6mm	3/8"	
FGA 381/3N	6mm	1/2"	



CODE	AIR OUTLET	BSP THREAD	
FGA 381/4N	6mm	1/4"	
FGA 381/5N	6mm	3/8"	



CODE	BSP THREAD	
FGA 380/1N	1/2"	
FGA 380/2N	1/4"	
FGA 380/3N	3/8"	



CODE	BSP THREAD	
FGA 380/4N	1/2"	
FGA 380/5N	1/4"	
FGA 380/6N	3/8"	



Lubricating oil for pneumatic tools

- 500CC
- Density 20°: 875 Kg/m³
- Viscosity 40°: 32 cST
- Flammability COC: 210°

CODE	
FGA 388/OL	

Universal swivel coupling



CODE	BSPT THREAD	BSP THREAD	
FGA 380/SN	1/4"	1/4"	

NEW





FGA 302/KIT
Maintenance
kit for FGA 302

CODE	
FGA 302/KIT	



FGA 303/KIT
Maintenance
kit for FGA 303

CODE	
FGA 303/KIT	



FGA 304/KIT
Maintenance
kit for FGA 304

CODE	
FGA 304/KIT	

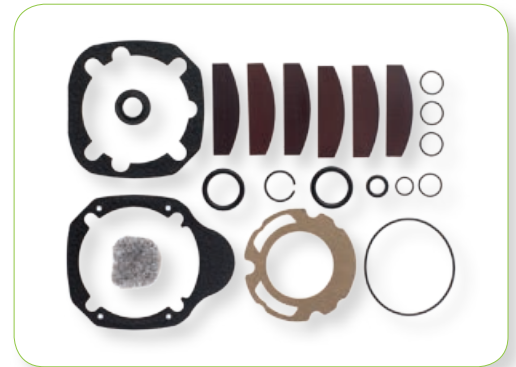

FASANO
TOOLS

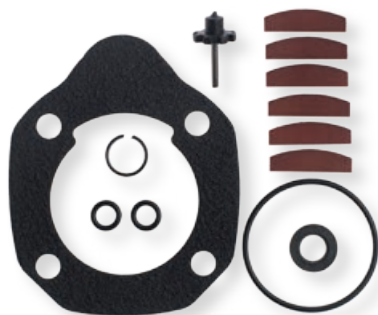

FGA 307/KIT
Maintenance
kit for FGA 307

CODE	
FGA 307/KIT	



FGA 309/KIT
Maintenance
kit for FGA 309

CODE	
FGA 309/KIT	



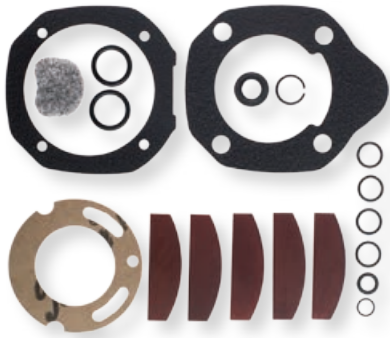

FGA 312/KIT
Maintenance
kit for FGA 312

CODE	
FGA 312/KIT	



FGA 316/KIT
Maintenance
kit for FGA 316

CODE	
FGA 316/KIT	

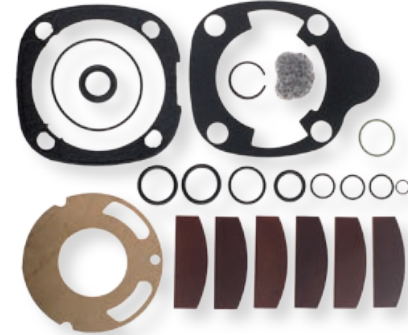

FGA 319/KIT
Maintenance
kit for FGA 319

CODE	
FGA 319/KIT	



FGA 321/KIT
Maintenance
kit for FGA 321

CODE	
FGA 321/KIT	



FGA 321B/KIT
Maintenance
kit for FGA 321/B

CODE	
FGA 321B/KIT	





FGA 338/KIT
Maintenance kit
for FGA 338

CODE	
FGA 338/KIT	

FGA 334/KIT
Maintenance kit
for FGA 334

CODE	
FGA 334/KIT	



FGA 338B/KIT
Maintenance kit
for FGA 338/B

CODE	
FGA 338B/KIT	



FGA 338AN/KIT
Maintenance kit
for FGA 338/AN

CODE	
FGA 338AN/KIT	

FGA 334AN/KIT
Maintenance kit
for FGA 334/AN

CODE	
FGA 334AN/KIT	



FGA 334AN115/KIT
Maintenance kit
for FGA 334AN115/KIT

CODE	
FGA 334AN115/KIT	



FGA 338L/KIT
Maintenance kit
for FGA 338/L

CODE	
FGA 338L/KIT	

FGA 334L/KIT
Maintenance kit
for FGA 334/L

CODE	
FGA 334L/KIT	





FGA 339B/KIT
Maintenance kit
for FGA 339/B

CODE	
FGA 339B/KIT	



FGA 340/KIT
Maintenance kit
for FGA 340

CODE	
FGA 340/KIT	40,00



FGA 338B/KIT
Maintenance kit
for FGA 338/B

CODE	
FGA 341/KIT	



FGA 342/KIT
Maintenance kit
for FGA 342

CODE	
FGA 342/KIT	



FGA 345/KIT
Maintenance kit
for FGA 345

CODE	
FGA 345/KIT	

