

Chief

impulse - EVHT

USERS MANUAL



CHIEF'S LIMITED ONE-YEAR WARRANTY & LIABILITY

Chief Automotive Technologies warrants for one year from date of installation and/or purchase any components of its *impulse-E/VHT* Repair System which do not perform satisfactorily due to defect caused by faulty material or workmanship. Chief's obligation under this warranty is limited to the repair or replacement of products which are defective and which have not been misused, carelessly handled, or defaced by repair or repairs made or attempted by others.

CHIEF AUTOMOTIVE TECHNOLOGIES DOES NOT ASSUME RESPONSIBILITY FOR ANY DEATH, INJURY OR PROPERTY DAMAGE RESULTING FROM THE OPERATOR'S NEGLIGENCE OR MISUSE OF THIS PRODUCT OR ITS ATTACHMENTS. CHIEF MAKES NO WRITTEN, EXPRESS OR IMPLIED WARRANTY WHATSOEVER OF MERCHANTABILITY OR FITNESS FOR A PARTICULAR PURPOSE OR OTHERWISE REGARDING THE EQUIPMENT OR ANY PART OF THE PRODUCT OTHER THAN THE LIMITED ONE-YEAR WARRANTY STATED ABOVE.

Chief *impulse-E/VHT*

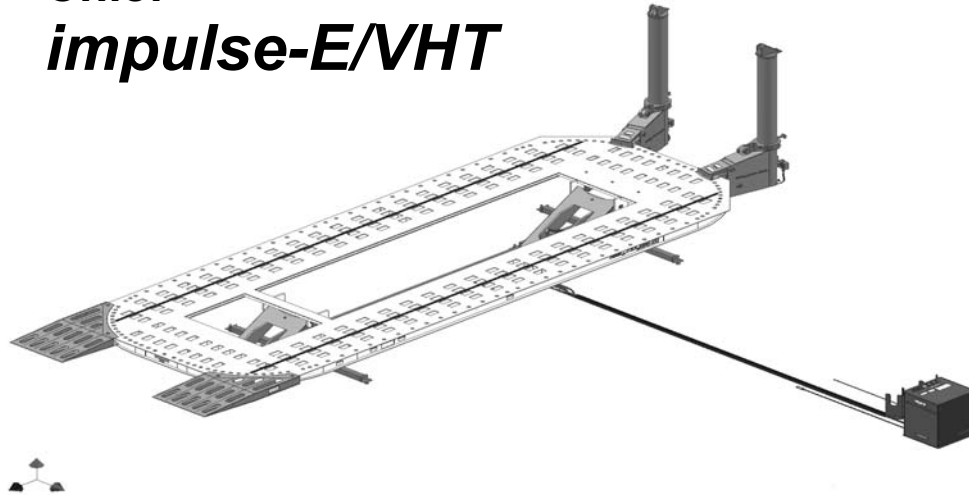

STOP! This machine is shipped without oil in the reservoir. Fill the reservoir to within 1” (25 mm) of the fill port using SUS 215 viscosity @ 100°F (38°C) 10W hydraulic oil prior to operating.

This owners manual is written to familiarize operators with the safe and efficient operation of the Chief *impulse-E/VHT*. The *impulse-E/VHT* machine features unibody and full frame repair capabilities with 360 degree pulling access around the vehicle.

Two towers are provided with the *impulse-E/VHT* and up to two more can be added as optional equipment. Each tower mounts to the bottom plate of the mainframe. A unique tower roller design allows easy movement around the machine and a “Sure-Lock” force clamp secures the tower to the mainframe when making a pull. Each tower is equipped with one 10-ton hydraulic ram operated by an electric over hydraulic pump. The machine is hydraulically positioned at various working heights, and tilts hydraulically for either drive-on or winch-on positioning of vehicles.

NOTE: Illustrations shown in this manual may vary slightly from actual product.

This manual is not intended to replace Chief Automotive Training. For information concerning Training, contact Chief Automotive Technologies

IMPORTANT:

1. DO NOT attempt to operate the Chief *impulse-E/VHT* without first reading this entire manual.
2. Complete safety information is highlighted throughout this manual and is identified by: 
This safety alert symbol identifies safety information. Operator injury could result if these CAUTION notes are not followed.
3. Qualified service personnel must check operational capacity of the Chief *impulse -E/VHT* system prior to its initial use and at intervals of no more than one year. Contact Chief Automotive Technologies or contact your authorized Chief Automotive Technologies representative.
4. Persons operating the Chief *impulse-E/VHT* repair system must be at least 18 years of age, must be trained in the operation of the *impulse-E/VHT* system, and must have demonstrated their qualifications to the employer. They must also be specifically assigned to operate the *impulse-E/VHT* system by the employer and this assignment must be made in writing.

IMPORTANT SAFETY INSTRUCTIONS

When using your garage equipment, basic safety precautions should always be followed, including the following:

1. Read all instructions.
2. Care must be taken as burns can occur from touching hot parts.
3. Do not operate equipment with a damaged cord or if the equipment has been dropped or damaged - until it has been examined by a qualified service person.
4. Do not let a cord hang over the ledge of the table, bench, or counter or come in contact with hot manifolds or moving fan blades.
5. If an extension cord is necessary, a cord with a current rating equal to or more than that of the equipment should be used. Cords rated for less current than the equipment may overheat. Care should be taken to arrange the cord so that it will not be tripped over or pulled.
6. Always unplug equipment from electrical outlet when not in use. Never use the cord to pull the plug from the outlet. Grasp plug and pull to disconnect.
7. Let equipment cool completely before putting away. Loop cord loosely around equipment when storing.
8. To reduce the risk of fire, do not operate equipment in the vicinity of open containers of flammable liquids (gasoline).
9. Keep hair, loose clothing, fingers and all parts of the body away from moving parts.
10. To reduce the risk of electric shock, do not use on wet surfaces or expose to rain.
11. Use only as described in this manual. Use only manufacturer's recommended attachments.
12. **ALWAYS WEAR SAFETY GLASSES.** Everyday eyeglasses only have impact resistant lenses, they are not safety glasses.

SAVE THESE INSTRUCTIONS

General Safety Tips

General

-  DO NOT operate this machine unless:
- 1) You are authorized in writing by your employer.
 - 2) All towers are properly secured to machine.
 - 3) Vehicle's wheels are blocked and parking brake is set.
 - 4) Load is 10,000 lbs or less.
 - 5) Field of motion of load carrying device is free of persons and obstructions.

 Persons operating the *impulse* repair system must be at least 18 years of age, must be trained in the operation of *impulse* system, and must have demonstrated their qualifications to the employer.

 DO NOT attempt to operate the *impulse* pulling system without first reading this entire manual.

 Always wear safety glasses when using the *impulse* machine or any of its accessories.

 DO NOT move machine if vehicle is on it.

 Maintain a free space of 20 inches (50cm) minimum around all moving parts and pinch points on machine.

Optional Crossmember

 DO NOT use optional crossmember as a step.

 DO NOT use optional crossmember to make angular pushes or pulls.

 During removal and reinstallation of optional crossmember, hold crossmember firmly to support its weight. Use a helper if needed. Following installation, install support pins at each end of crossmember to prevent accident disengagement.

 To Avoid Damage to the lift assemblies or the hydraulic power unit:

- Crossmember must be installed and located properly when Raising or Lowering Equipment

Collar

 To avoid accidental dropping of tower collar, tighten collar locking knob and or lower collar to bottom of tower.

 Collar locking knob must be tightened before removing tower chain from vehicle.

Tower Movement



WARNING

Fully engage "Sure-Lock" force clamp with pinning hole on mainframe to prevent tower movement during the pull or during a raising or lowering procedure.



When pushing tower, keep one hand on tower lever and the other on the tower pipe above the collar. Also, keep hands away from all pinch points...i.e. roller assemblies on bottom mainframe plate and force clamp pinning location on top mainframe plate.



When engaging "Sure-Lock" force clamp, keep hands away from all pinch points...i.e. roller assemblies on bottom mainframe plate and force clamp pinning location on top mainframe plate.

NOTE: Hoses may need to be disconnected when moving towers around the front and rear of machine.

Pulling



WARNING!

To avoid severe personal injury to yourself and others: DO NOT position yourself close to, or in line with chains, clamps, or other accessories while pressure is applied to this system.



To prevent personal injury from flying objects:

- Check all bolts, nuts and clamps for deformation or elongation prior to each use.
- Deformed or elongated materials must be replaced.
- If materials look deformed, they are deformed. Replace them.



Remove twist in chain before applying pressure to the chain.

Raise / Lower Machine



When raising or lowering machine, secure towers to front of mainframe. The "Sure-Lock" force clamps must firmly engage pinning holes at that location and tower levers must be down



Lifting of persons is prohibited.











Keep feet and objects clear of mainframe when lowering machine.

General Safety Tips (continued)



-  To Avoid Personal Injury or Damage to Equipment:
 - Before operating the machine make sure:
 - Persons and objects are clear of machine
 - Hoses and other objects are free of the lift legs.
 - Oil spills must be cleaned up immediately to prevent slipping.
 - Hoses on the floor can create a tripping hazard.

Loading / Unloading Machine







Prior to driving or winching vehicle on or off the machine make sure loading ramps are installed correctly.

-  When driving or winching a vehicle on or off machine, use helper to guide you. If vehicle's brakes are inoperable, use a Chief Winch and refer to instructions packaged with that accessory.
-  Immediately after positioning vehicle on mainframe, put vehicle in park (if automatic transmission), apply vehicles emergency brake, and have helper install wheel chocks at "front" of front tire and at "rear" of rear tire. Install wheel chocks as close to the tires as possible to prevent vehicle movement and keep wheel chocks installed whenever vehicle is not anchored to mainframe.
-  Position vehicle far enough onto mainframe so that wheels do not rest on loading ramps. DO NOT use ramps to lift or hold a load off of the floor. Remove ramps before raising machine.
-  Before lowering machine, put vehicle in park (if automatic transmission), apply vehicles parking brake, and install wheel chocks. Then check to make sure loading ramps are installed correctly.
-  DO NOT run over air hoses or hydraulic lines when loading or unloading vehicles.
-  DO NOT exceed the machine's 10,000 lbs. (4,535 kg.) lifting capacity.
-  When raising or lowering machine with vehicle aboard, DO NOT walk behind rear of machine.
-  Always install wheel chocks when raising or lowering machine with a vehicle aboard.

Chain

-  The 1/2" tower chain is proof tested to 28,000 lbs. (124kN).
-  To avoid personal injury or damage to property, DO NOT:
 - Heat chain or hook while repairing vehicle. 600 degrees F (316 degrees C) of heat on chain will weaken it.
 - Tip load chain hook.
 - Pull with twisted chain links.

Hydraulics

-  Keep pumps far away from excessive heat or flames. The surrounding temperature should not exceed 122° F (50° C).
-  Always release hydraulic pressure before disconnecting hydraulic hoses.
-  If pump fails to shut off, disconnect electric supply and contact an authorized Chief Automotive Technologies Service Representative.
-  All components must be replaced with Chief Automotive Technologies authorized replacement parts.
-  Improper handling and/or modification of parts is forbidden and may cause a hazardous situation for the user. Such action immediately voids the warranty and releases the manufacturer from all liability.
-  Keep pump in upright position. DO NOT turn pump upside down or lay on its side.
- 
 1. Fill pump reservoir with all cylinders retracted and deck in lowest working position. (See Maintenance Section - page 14.)
 2. DO NOT overfill pump reservoir.

Operational Capacity

-  Qualified service personnel must check operational capacity of *impulse* system prior to its initial use and at intervals of no more than one year. Contact Chief Automotive Technologies or contact your authorized Chief Automotive Technologies representative.

Optional Steps / Ladders

-  Use only approved steps and ladders when working on or around this equipment.

Hydraulic System Components

The Chief E/VHT system is powered by an electrically operated hydraulic pump which is controlled by a remote control switch. Refer to the E/VHT Parts Manual (Chief #450429) for component detail.

Hydraulic pressure is distributed to tower cylinders, auxiliary cylinders, and lift cylinders. The flow of hydraulic fluid to tower and auxiliary cylinders is controlled by individual valves located in each auxiliary line. The flow of hydraulic fluid to the lift cylinders is controlled by an electric switch mounted on the pump cabinet top panel. Hydraulic pressure is monitored by gauges mounted on the towers. To exert hydraulic pressure, press "UP" button on the hand-held control unit. To release hydraulic pressure, press "DOWN" button.

NOTE: Although the E/VHT is a low pressure system, it builds hydraulic pressure quickly. Be aware of this quick reaction when making pulls or lifting vehicles.

Important:

Tower cylinders and auxiliary cylinders can be operated either simultaneously (with equal hydraulic pressure) or individually. The lift cylinders must not be operated while any tower or auxiliary cylinders are operating. When ever using the hydraulic system, close all valves where hydraulic pressure is not required.

 **CAUTION:** To avoid personal injury or damage to property: When disconnecting hydraulic hose from quick coupler, some fluid spillage may occur. Always clean up any hydraulic fluid spillage from floor or work area.

Initial Setup

The E/VHT requires a compressed air supply to activate the safety lock releases. Before using the E/VHT, it is necessary to install a customer supplied air coupler. The E/VHT cabinet is equipped with a 1/4" Female NPT port on the back. (See Figure 1.)

Two hose hanging brackets are included with the E/VHT. To install these brackets, loosen the top four screws on the cabinet back panel. Then insert the hanging bracket key slot over the screws. Finally, retighten the screws. (See Figure 2.)

The E/VHT cabinet must be connected to the mainframe manifold. First insert the tilt cord to the port-a-frame bulkhead receptacle. The cord is keyed so it will only connect one way. Hand tighten the retaining collar. Next connect the black pneumatic line to the lower bulkhead fitting and the natural pneumatic line to the top fitting. (To connect the pneumatic lines, firmly push the hose into the fitting until it is firmly seated.) Finally, connect the front and rear lift hydraulic lines. The line marked with the black heat shrink tape connects to the coupler closest to the pneumatic fittings. (See Figure 3.)

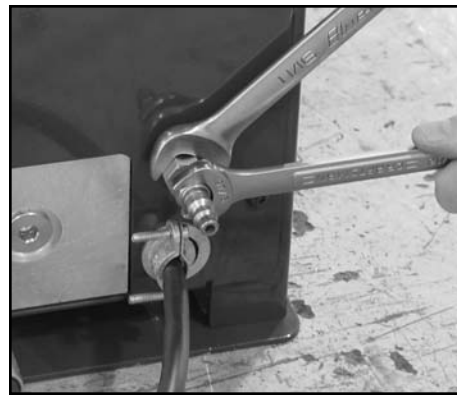

Figure 1



Figure 2



Figure 3

Pump Usage

STOP! This machine is shipped without hydraulic oil. Fill the reservoir to within 1" (25 mm) of the fill port using SUS 215 viscosity @ 100°F (38°C) 10W hydraulic oil prior to operating.

1. To activate hydraulic pump to apply pressure to system to raise machine or towers, depress "UP" button on the hand-held control unit. The pump will build hydraulic pressure in the system to activate lift, tower, or auxiliary hydraulic cylinders.
2. To disengage the hydraulic pump, release "UP" button on hand-held control unit. (See Figure 4.) This action stops the flow of hydraulic oil to the system being operated: However, the system holds existing hydraulic pressure.
3. To release hydraulic pressure, depress the "DOWN" button on the hand-held control unit. (See Figure 5.) This will release the hydraulic pressure in the system and return hydraulic oil to the pump reservoir.

CAUTION: To prevent damage to the pump and



Figure 4



Figure 5

Towers

The *impulse-E/VHT* repair system is equipped with two pulling towers that can be positioned 360 degrees around the machine. The system can accommodate up to two additional towers. All towers feature telescoping heads, adjustable collars, and a unique roller assembly that not only secures the tower to the bottom of the machine but also allows for 360 degree movement around the machine.

Also unique to this system are the “Sure-Lock” force clamps that secure towers to circular pinning holes along the outer edge of the mainframe. The force clamps secure towers to the mainframe while removing stress from the roller assemblies.

Tower pulls can be set up quickly and are controlled by a hand-held pendant, which controls the flow of hydraulic pressure, and individual tower valves which control the flow of oil to each tower. Lateral and elevated pulling angles can be made or changed in just a fraction of a minute.

 **CAUTION:** The 1/2 inch (13mm) tower chain is proof tested to 28,000 lbs. (124kN).

To Operate Towers

1. Step on “Sure-Lock” release handle to unlock “Sure-Lock” force clamp from mainframe. (See Figure 6.)
2. Rotate “Sure-Lock” lock handle forward to fully open Sure-Lock. (See Figure 7.)
3. Push tower to desired location on machine. (See Figure 8.)

 **CAUTION:** When pushing tower, keep one hand on “Sure-lock” lock handle and other hand on tower pipe above collar. Also, keep hands away from all pinch points...i.e. roller assemblies on bottom of mainframe plate and force clamp pinning locations on top mainframe plate.



Figure 6



Figure 7



Figure 8

4. To secure tower to mainframe, rotate “Sure-lock” lock lever back and down to engage “Sure-Lock” force clamp with mainframe pinning hole. (See Figure 10.) Fully lock “Sure-Lock” by stepping on lock lever. “Sure-Lock” force clamp is fully engaged when outer tower rollers are raised above the outer track. (See Figure 9.)

 **WARNING**

Fully engage “Sure-Lock” force clamp with pinning hole on mainframe to prevent tower movement during the pull or during a raising or lowering procedure.

-  **CAUTION:** When engaging “Sure-Lock” force clamp, keep hands away from all pinch points...i.e. roller assemblies on bottom mainframe plate and force clamp pinning location on top mainframe plate.

5. To adjust slack tower chain, grip chain on each side of the tower. Lift out on tail of chain until it is approximately 45 degrees from tower. Then disengage chain from tower head and pull chain to either increase or decrease amount of slack. (See Figure 11.)

6. Support collar with one hand while loosening collar locking knob with opposite hand. Then position collar approximately 3 inches (75mm) above desired pulling height and retighten collar locking knob. (See Figure 12.)

7. Let tower chain hang free momentarily to remove twist. Then without twisting chain, attach hook to the vehicle. Pull on tail end of chain to remove slack (See Figure 13.) and then lower collar.

IMPORTANT: Remove twist from chain before lowering collar. Make sure that chain links between collar roller and hook align.



Figure 9

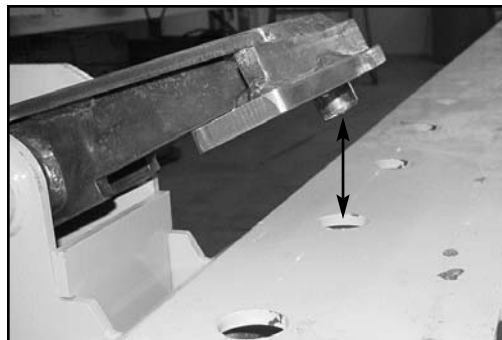

Figure 10

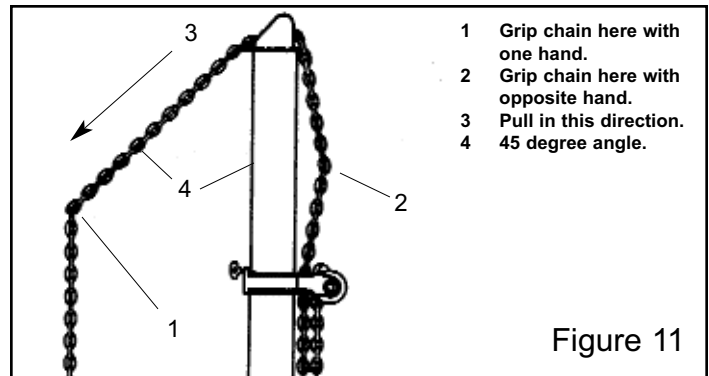

Figure 11

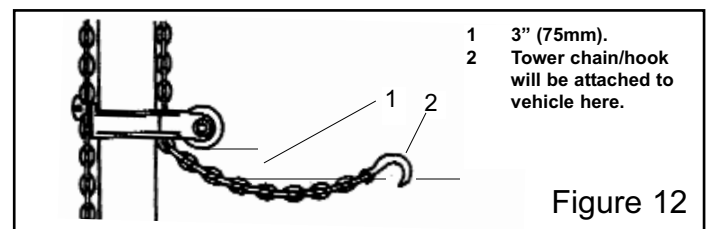

Figure 12

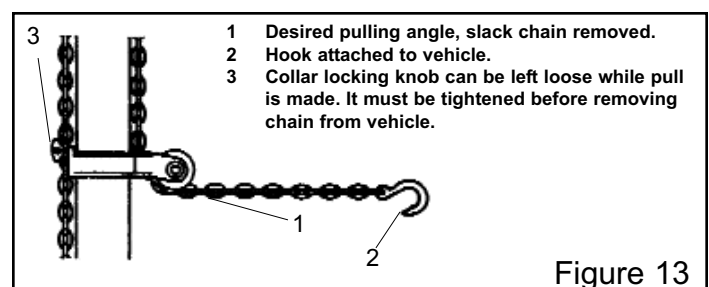

Figure 13

8. Attach pump's hydraulic hose to tower ram's quick coupler. (See Figure 14.)
9. To operate pump, follow usage procedures on page 6.

CAUTION:

1. To prevent damage to tower assembly, pulls must not exceed a 45 degree angle from tower base. (See Figure 15.)
2. To avoid personal injury or damage to equipment, DO NOT:
 - Heat chain hook while repairing vehicle. 600 degrees F (316 degrees C) of heat on chain will weaken it.
 - Tip load chain hook.
 - Pull with twisted chain links.

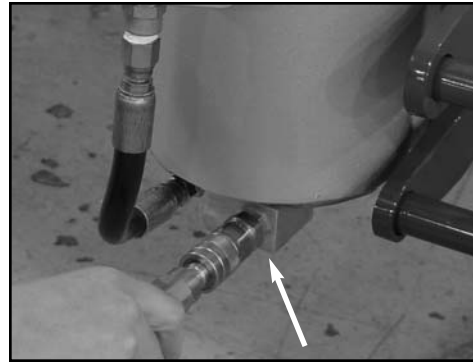

Figure 14

Warning

To avoid severe personal injury to yourself and others: DO NOT position yourself close to, or in line with chains, clamps, or other accessories while pressure is applied to this system.

IMPORTANT:

1. DO NOT tighten collar locking knob while pressure is applied to system because it will be impossible to loosen the knob without pressure on the system. If it has been tightened by error while pressure is on the system, reapply pressure and loosen the knob.
 2. DO NOT wrap tower chain around track nor attach tower hook to track. Damage to track will impede tower usage.
10. When tower is no longer needed, disconnect hydraulic hose from tower ram's quick coupler, remove tower chain and hook from vehicle and store collar using one of the two methods shown in Figures 16 and 17.

CAUTION:

1. Collar locking knob must be tightened before removing tower chain and hook from vehicle.
2. Collar locking knob must be tight when collar is not in use.
3. Store collar at bottom of tower pipe or support collar with tower chain.

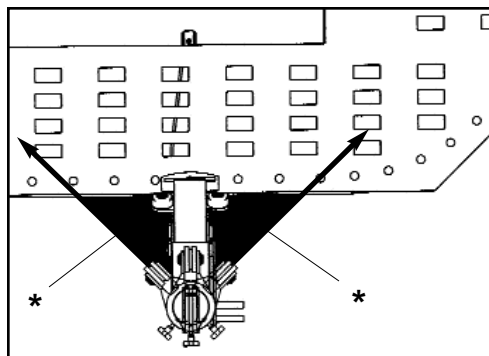

* Pulling Angle Must Not Exceed 45 Degree Range From Tower Base.

Figure 15

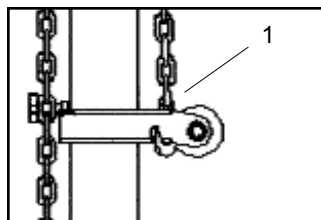

Figure 16

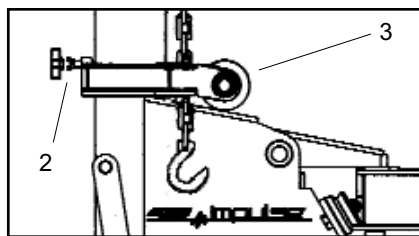

Figure 17

- 1 Collar supported by Tower Chain.
- 2 When collar and chain are stored this way, collar locking knob must be tightened before removing tower chain and hook from vehicle.
- 3 Collar rests on tower base.

Optional Crossmember

An optional crossmember is available for the *impulse* system. The crossmember (See Figure 18.) mounts to the inside edges of the treadway and can be moved forward or rearward as needed. The crossmember does not lock to the machine; however, support pins (See Figure 20.) prevent it from being accidentally disengaged.

The primary use of the crossmember is to support perpendicular pulls and pushes. In both instances, the auxiliary ram must be positioned perpendicular with top or bottom of crossmember.

To install the crossmember, hold it secure while rotating it into position. (See Figure 19.) Both ends of the crossmember must engage top mainframe plate. Then secure support pins (See Figure 20.) at each end of the crossmember.

CAUTION:

1. DO NOT use movable crossmember as a step.
2. DO NOT use movable crossmember as a base to make a hydraulic pull or push unless auxiliary ram is positioned perpendicular (90 degrees) with top or bottom of crossmember.
3. Each time crossmember is removed from mainframe and reinstalled, reinstall support pins at each end of the crossmember to prevent accidental disengagement.
4. DO NOT make angular pulls or pushes from the crossmember.

Reverse Usage - Optional Crossmember

If additional height is required for lifting high ground clearance vehicles, the crossmember can be turned upside down to provide a higher platform. (See Figure 21.) Bridging the treadways in this fashion provides an additional 5 inches of height.

 **CAUTION:** When crossmember is installed as shown in Figure 21 use extreme caution.

1. Use this setup only when mainframe is in level position.
2. Center crossmember evenly from side to side.
3. Remove crossmember before lowering machine.
4. Use this setup for perpendicular lifting only. DO NOT use this setup for any type of pull.
5. DO NOT position yourself close to or underneath the crossmember when lifting the vehicle.
6. Take caution to position crossmember when raising and lowering machine so that it does not damage the lift arm or pump.

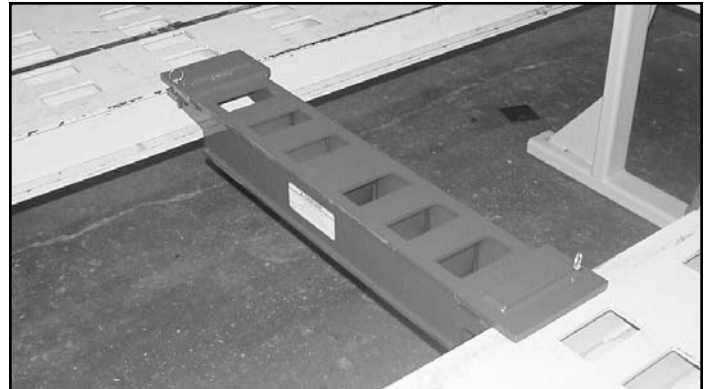

Figure 18



Figure 19

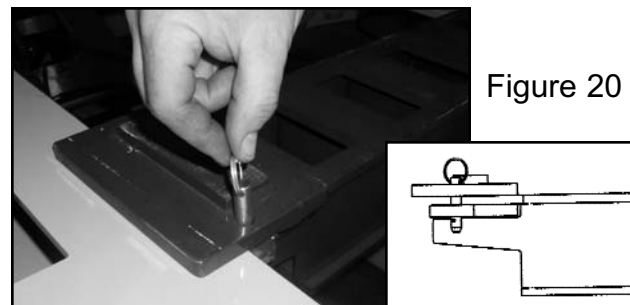

Figure 20

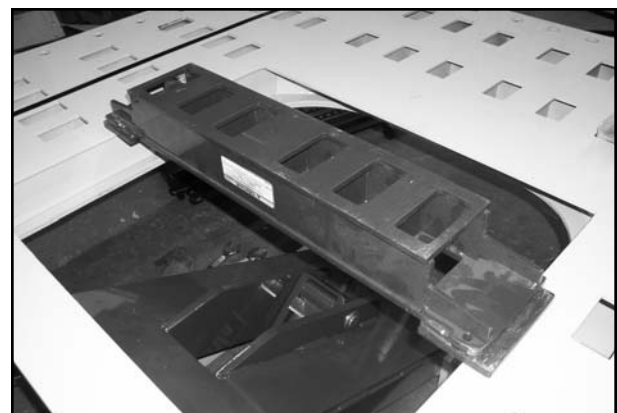

Figure 21

Lowering / Raising Machine

When lowering or raising a machine with a vehicle aboard observe the following precautions.

CAUTION:

1. When driving or winching vehicle on or off machine, use a helper to guide you. (See Figure 22.) If vehicle's brakes are inoperable, use a Chief Winch and refer to instructions packaged with that accessory.
2. When vehicle is on mainframe, all wheels must clear the loading ramps. (See Figure 23.) DO NOT attempt to lift machine with vehicle's wheels on the loading ramps. Remove ramps before raising machine.
3. Immediately after positioning vehicle on mainframe, put vehicle in park (if automatic transmission), and apply vehicles emergency brake. Continue to press brake pedal until helper installs wheel chocks (See Figure 24.) at "front" and "rear" of rear tires.
4. Prior to lowering machine, put vehicle in park (if automatic transmission), apply vehicles emergency brake, and install wheels chocks at front of front tires and rear of rear tires. Then install loading ramps at rear of machine.
5. Keep vehicles wheels blocked during raising and lowering procedures and whenever vehicle is not anchored to mainframe.
6. When raising or lowering machine with vehicle aboard, DO NOT walk behind machine.
7. DO NOT exceed 10,000 lbs. (4,535 kg) lifting capacity of *impulse-E/VHT* system.



Figure 22

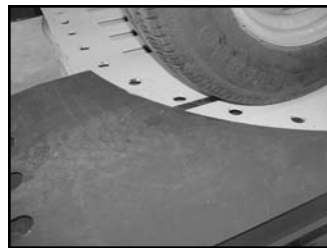

Figure 23



Figure 24

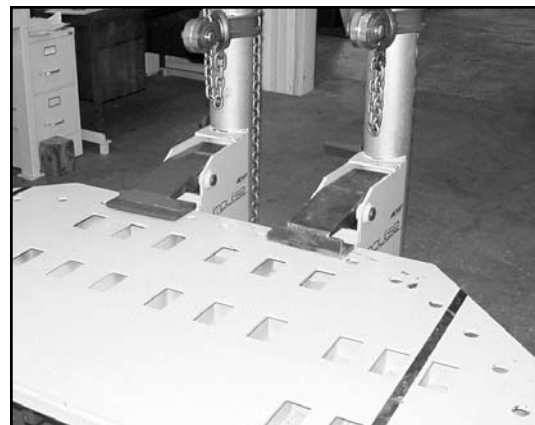

Figure 25

To Lower Machine For Loading

IMPORTANT: Observe preceding precautions when lowering machine with vehicle aboard.

1. Position towers at front of machine and secure the "Sure-Lock" force clamps to front pinning holes. (See Figure 25.)
2. Install loading ramps at rear of machine. (See Figure 26.)

NOTE: Loading Ramp pins must engage loading ramp pinning holes at rear corners of machine. (See Figure 26 Inset.)

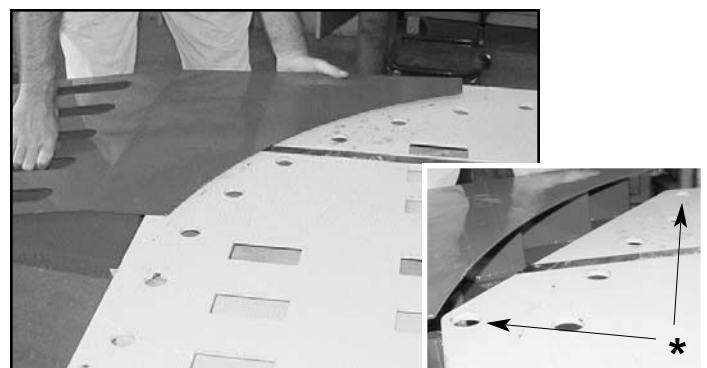

Figure 26

* Loading Ramp Pinning Holes On Mainframe

3. Turn off all auxiliary line valves or disconnect all tower and auxiliary cylinders from system. (See Figure 27.)
4. Turn lift switch on pump cabinet to "ON" position. (See Figure 28.)
5. Raise machine until it is level and front lock arm is above red stripe on porta-frame. (This corresponds to the 4th working height) (See Figure 29.)
6. Activate the tilt lock arm release by depressing and holding the tilt button on the pump cabinet. (See Figure 30.)
7. Depress and hold the "DOWN" button on the hand-held control unit. The machine will automatically tilt into the loading position. (See Figure 31.)



Figure 27

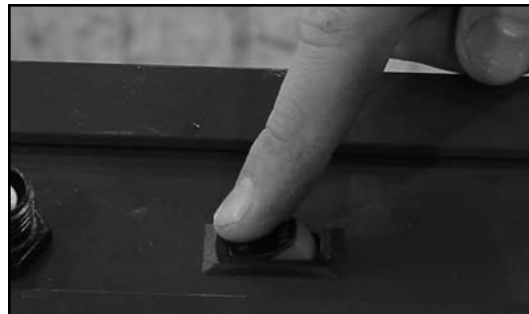

Figure 28



Figure 29



Figure 30



Figure 31

 **CAUTION:**

1. Before lowering machine, clear all obstacles from under and around machine.
2. DO NOT allow anyone or anything to ride on machine or be under machine during lowering procedures.
3. Position optional cross-member immediately ahead of rear fixed crossmember to avoid damage to the machine.

To Raise Machine After Loading

1. Turn off all auxiliary line valves or disconnect all tower and auxiliary cylinders from system. (See Figure 32.)
2. Turn lift switch on pump cabinet to "ON" position. (See Figure 33.)
3. Activate pump by depressing and holding "UP" button on hand-held control unit. Rear lift will rise until machine is level. Once machine is level, both lifts will rise together. (See Figure 34.)
4. After machine is above desired working height, release "UP" button on hand-held control unit to stop flow of hydraulic fluid from pump. Depress and hold "DOWN" button on hand-held control unit to lower machine into mechanical stops. (See Figure 35.)



CAUTION:

1. Before raising machine, verify that vehicle parking brake is set and automatic transmission is in park (if equipped).
2. DO NOT walk behind machine during raising procedures.
3. Install wheel chocks at front and rear of rear tires.



Figure 32

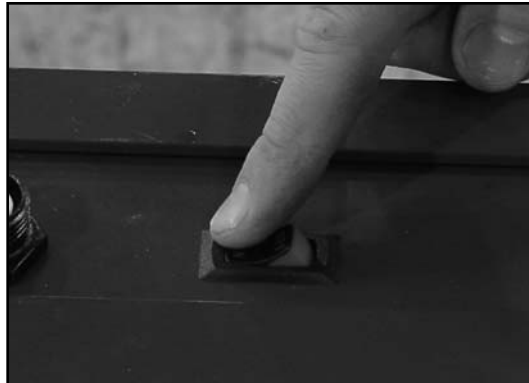

Figure 33



Figure 34



Figure 35

Adjust Working Heights

The *impulse-E/VHT* has six (6) working heights from 19 inches (480mm) to 40 inches (1010mm).

To Raise Machine Working Height

1. Turn off all auxiliary line valves or disconnect all tower and auxiliary cylinders from system. (See Figure 36.)
2. Turn lift switch on pump cabinet to "ON" position. (See Figure 37.)
3. Activate pump by depressing and holding "UP" button on hand-held control unit. Raise machine until both lifts are above desired working height. (See Figure 38.)
4. Depress and hold "DOWN" button on hand-held control unit to lower machine into mechanical stops. (See Figure 40.)



Figure 36

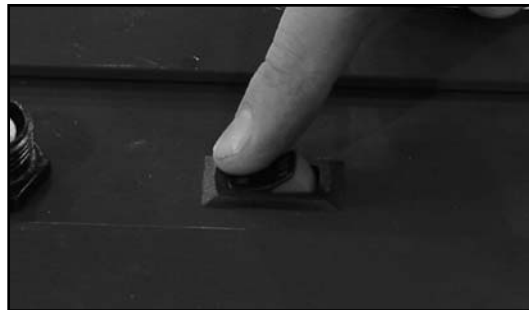

Figure 37

To Lower Machine Working Height

1. Turn off all auxiliary line valves or disconnect all tower and auxiliary cylinders from system. (See Figure 36.)
2. Turn lift switch on pump cabinet to "ON" position. (See Figure 37.)
3. Activate pump by depressing and holding "UP" button on hand-held control unit. Raise machine until both lock arms are released. (See Figure 38.)
4. Disengage safety lock arms by depressing and holding "UNLOCK" button on pump cabinet. (See Figure 39.)
5. Depress and hold the "DOWN" button on hand-held control unit until machine is slightly above desired working height. (See Figure 40.)
6. Release "UNLOCK" button on pump cabinet to reengage safety lock arms. Continue to depress "DOWN" button on hand-held control unit until machine settles into locks.



Figure 38

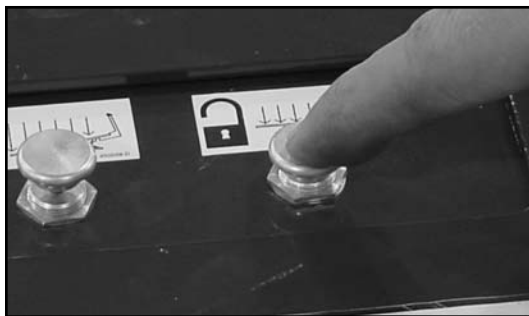

Figure 39



Figure 40

Machine Maintenance

Check And Inspect

These components should be checked prior to use and anytime a problem is suspected.



CAUTION: To avoid personal injury when performing any maintenance function, always wear safety glasses and safety shoes.

Tower Chains, Tie-Down Chains

1. Clean chain before inspecting.
2. Inspect each link for wear, nicks, gouges, stretched or bent links. If found, replace chain.
3. Inspect tower hooks for twist and stretched openings. If found replace chain.



CAUTION: To avoid personal injury or damage to property, DO NOT:

- Heat chain or hook while repairing vehicle. 600 degrees F (316 degrees C) of heat on chain will weaken it.
- Tip load chain hook.
- Pull with twisted chain links.

Loading Ramps

Inspect loading ramps making sure loading ramp pins mate with pinning holes at rear of machine each time mainframe is raised or lowered.

Inspect inside and outside tower roller wheels for damage. The inside and outside roller bearings are lubrication free. Use compressed air to clean. DO NOT lubricate.

Power and Control Cords

Inspect hydraulic hoses and air hoses for leaks or other damage. If found, replace hose(s).

Cleaning and Lubricating

Clean and lubricate these components as specified for trouble free and extended service. When lubricating use the following:
Oil — Use 30 weight motor oil for all components requiring oil.

Grease — Use a SUS750 Lithium type grease such as lubricate #630-2 for all components requiring grease.

Tower Heads

Clean tower heads every six months.

1. Remove tower chain from tower head.
2. Remove tower head from tower pipe.
3. Clean dirt from tower head pipe and where tower head pipe rubs on inside of tower pipe.
4. Reinstall tower head and tower chain.

Collars

Clean and lubricate collars monthly.

1. Use compressed air to blow out dirt or dust that collects between collar ears and rollers.



CAUTION: Wear safety glasses while using compressed air to blow out dirt and dust.

2. Place a few drops of oil on roller pin between roller and collar ears (each side). Then turn roller a few times. Roller must turn freely.

Eliminating Air In Hydraulic System

All air has been removed from hydraulic system at the factory, but if hydraulic system is opened to replace a system component, it is necessary to bleed air from system prior to using it.

Bleeding Air In System At Tower Cylinder

1. Connect auxiliary line to tower cylinder and open auxiliary line valve.
2. Remove tower head and chain.
3. Fully extend tower cylinder by depressing and holding "UP" button on hand-held pendant until tower gauge shows 2 tons of pressure on system.
4. While holding rag over the top of the cylinder to prevent oil spray, use a 3/16" T-handle allen wrench, loosen cylinder top bolt 1/2 turn.
5. Rapid, side-to-side motion of the T-handle may be necessary to unseat the seal washer at the top of the cylinder.



CAUTION: Wear safety glasses to protect eyes from hydraulic oil in the event it squirts past rag.

6. Trapped air or trapped air/oil mixture (indicated by foam in the oil) should escape from top of cylinder. Wipe up any escaping oil with rag.
7. When cylinder is completely bled, only clean oil should escape from top of cylinder.

NOTE: It may be necessary to tighten top cylinder bolt and repressurize the system to 2 tons and repeat procedure.

8. Replace tower head and chain. Lower tower cylinder and refill reservoir to within 1" of fill port with all cylinders in retracted position.

Machine Maintenance (cont.)

Refill Hydraulic Fluid Reservoir

The hydraulic pump contains 2.9 gallons (11 liters) of hydraulic oil. When refilling or adding oil, fill to within 1" (25mm) of fill port using SUS 215 viscosity @ 100°F (38°C) 10W Hydraulic Oil.

Caution:

1. Fill pump reservoir with all cylinders retracted and deck at lowest working height.
2. DO NOT overfill pump reservoir.

Lift & Porta-frame Assembly

All lift leg and porta-frame pivot points are permanently lubricated and do not require maintenance except for occasional cleaning.

Unlock Unload System

1. Position towers at front of machine and secure "Sure-Lock" force clamps to front pinning holes.
2. Raise machine and lock deck at top working height.
3. Use compressed air to blow out dirt and dust that collects in unlock and unload mechanisms.

Caution: Wear safety glasses while using compressed air to blow out dirt and dust.

4. Visually inspect unlock and unload mechanisms for wear and damage. Verify that all bolts are tight and undamaged.
5. Starting at lowest working height raise machine to top of lift cylinder travel. It should be possible to hear both the front and back lock arms drop into each position on the sawtooth.
6. As machine is rising, activate both unlock and unload buttons on pump cabinet. Both should raise the safety lock arms quickly.
7. Contact Chief Automotive Systems or your authorized Chief Automotive Systems representative if there are any problems.

Leveling Machine

1. Position towers at front of machine and secure the Sure-Lock force clamps to front pinning holes. (See Figure 41.)
2. Raise machine and lock into top working height.
3. Place level across port-a-frame front stabilizer bar and adjust leveling bolts at location 1 until bar is level. (See Figures 42 & 43.) To adjust the leveling bolt, first loosen the top nut as shown in Figure 44. Then adjust the lower nut to raise the porta-frame as shown in Figure 45 and then re-tighten top nut. Verify that the deck is level across the front.
4. Place level lengthwise on the deck treadway, about 1/2 way back on the machine. Adjust the leveling bolts at location 3 (See Figure 42.) until the deck is level front to rear on both sides.
5. Place level across the back of the deck to verify level.
6. After the deck is level adjust the remaining leveling bolts down until they contact the floor. Then turn an additional 1/2 turn. Start with bolts at location 2 and 4 (See Figure 42.)



Figure 43

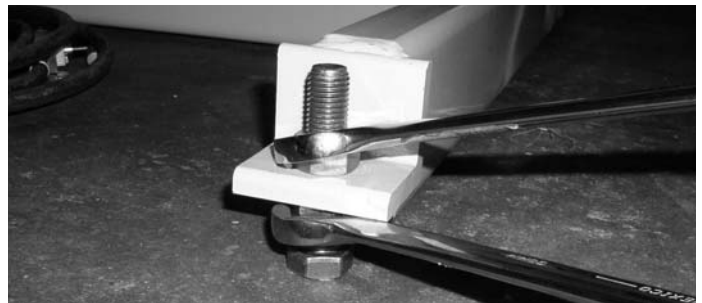

Figure 44



Figure 45

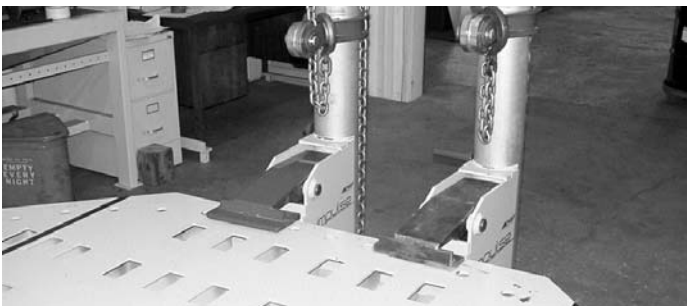

Figure 41

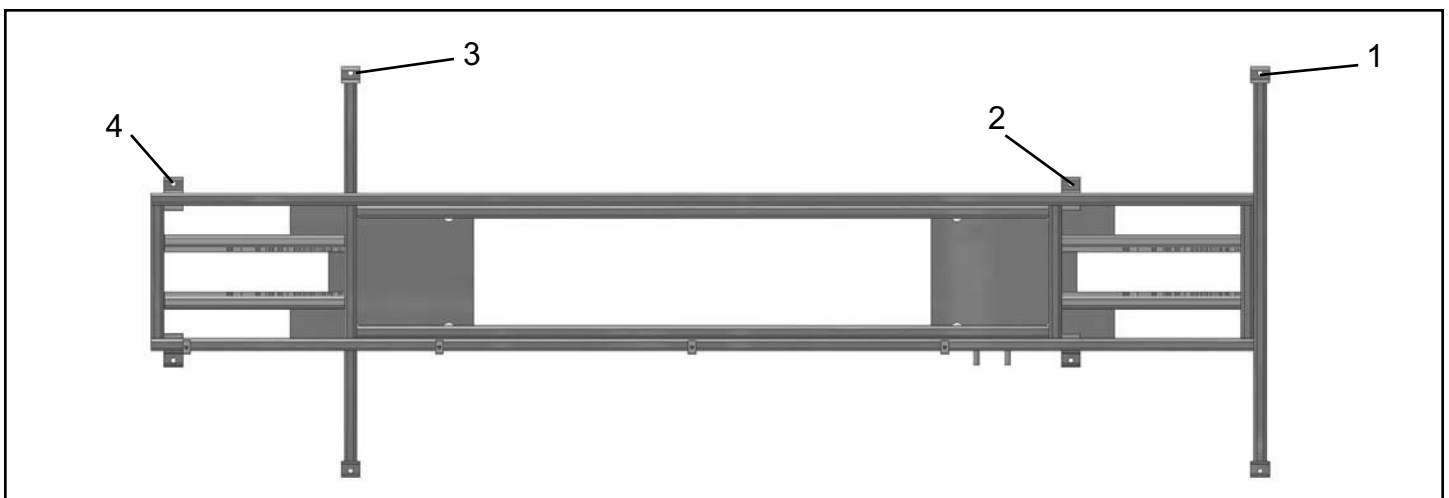

Figure 42

Troubleshooting

Problem	Possible Cause	Possible Solution
Pump will not run	Power cord disconnected	Plug in power cord
	<i>Circuit breaker tripped or blown fuse</i>	<i>Reset circuit breaker or replace fuse</i>
	Blown control board fuse	Replace control board fuse. (refer to parts manual)
	<i>Bad control board UP relay</i>	<i>Replace control board UP relay. (refer to parts manual)</i>
	Bad motor contactor	Replace motor contactor. (refer to parts manual)
	<i>Bad power cord</i>	<i>Clean and inspect power cord. Repair or replace if necessary</i>
	Bad control unit cord	Clean and inspect control unit cord for damage. Repair or replace if necessary
	<i>Bad control unit switch</i>	<i>Visually inspect control unit for damage. Repair or replace if necessary</i>
Pump will not build pressure or builds pressure slowly	Hydraulic fluid low	Fill reservoir to within 1" of fill port with SUS215 Viscosity @ 100 ° F (38°C) 10W hydraulic oil with all cylinders in retracted position
	<i>Bad V4 coil</i>	<i>Check for magnetic field at V4 coil. Replace if necessary. (refer to parts manual)</i>
	Contamination in control manifold V4 valve	Clean and inspect V4. Replace if necessary. (refer to parts manual)
Pump will not hold pressure	Hydraulic fluid leak	Inspect machine and area around machine for leaks. Repair leaks if necessary
	<i>Contamination in control manifold check valve</i>	<i>Clean and inspect check valve. Replace if necessary. (refer to parts manual)</i>
	Contamination in control manifold V3 valve	Clean and inspect check valve. Replace if necessary. (refer to parts Manual)
Pump will not start under pressure	Inadequate power	Pump requires 20 amp dedicated line. Full load voltage at pump should be 120 VAC ± 10%. Rewire facility to comply with local electrical code
	<i>Bad motor</i>	<i>Replace motor/pump assembly</i>
Tower cylinder jumps	Air in hydraulic system	Bleed hydraulic system (see page 14)
Tower cylinder will not extend	Auxiliary line valve not open	Open valve one turn
	<i>Auxiliary line not connected to tower</i>	<i>Connect auxiliary line to tower</i>
	Pump will not build pressure	See pump problems above
Tower cylinder will not retract	Air in hydraulic system	Bleed hydraulic system (see page 14)
	<i>Auxiliary line valve not open</i>	<i>Open valve one turn</i>
	Auxiliary line not connected to tower	Connect auxiliary line to tower
	<i>Control manifold V3 valve not opening</i>	<i>Remove and inspect V3. Clean or replace if necessary. (refer to parts manual)</i>
	Bad V3 Coil	Check for magnetic field at V3 coil. Replace if necessary. (refer to parts manual)
	<i>Bad control board DOWN relay</i>	<i>Replace control board DOWN relay. (refer to parts manual)</i>
	Tower head galling	Remove tower head and chain. Inspect tower head and inside of tower pipe for galling. If galling is found, contact Chief Automotive service representative
	<i>Bad cylinder</i>	<i>Repair or replace cylinder. Contact Chief Automotive service representative</i>

Troubleshooting - Cont.

Problem	Possible Cause	Possible Solution
Rear lift will not rise	Lift switch off	Turn lift switch ON
	<i>Auxiliary line valve open</i>	<i>Close all auxiliary line valves</i>
	Air in hydraulic system	Cycle machine to full pressure and zero pressure to purge
	<i>Too much weight at rear of machine</i>	<i>Move vehicle forward</i>
	Lifting capacity exceeded	Unload vehicle or do not attempt to load vehicle
	<i>Bad tilt switch</i>	<i>Inspect tilt switch, repair or replace if necessary. (refer to parts manual)</i>
	Cabinet to mainframe lift hoses not connected or connected backwards	Connect or reconnect lift hoses. Hose with black band connects to coupler closest to porta-frame bulkhead mini-line receptacle
	<i>Cabinet to mainframe control cord not connected</i>	<i>Connect cabinet to mainframe control cord</i>
	Pump not building pressure	See pump troubleshooting
	<i>Bad V2 coil</i>	<i>Check for magnetic field at V2 coil. Replace if necessary. (refer to parts manual)</i>
	Bad control manifold V2 valve	Remove and inspect V2. Clean or replace if necessary. (refer to parts manual)
Front lift will not rise	Lift switch off	Turn lift switch ON
	<i>Auxiliary line valve open</i>	<i>Close auxiliary line valves</i>
	Air in hydraulic system	Cycle machine to full pressure and zero pressure to purge air
	<i>Lifting capacity exceeded</i>	<i>Unload vehicle or do not attempt to load vehicle</i>
	Deck in tilted position	Raise back lift until deck is level
	<i>Bad tilt switch</i>	<i>Inspect tilt switch, repair or replace if necessary (refer to parts manual)</i>
	Cabinet to mainframe lift hoses not connected or connected backwards	Connect or reconnect lift hoses. Hose with black band connects to coupler closest to porta-frame bulkhead mini-line receptacle
	<i>Mainframe wiring damaged</i>	<i>Inspect mainframe wiring. Repair or replace if necessary (refer to parts manual)</i>
	Bad V1 coil	Check for magnetic field at V1 coil. Replace if necessary (refer to parts manual)
	<i>Bad control manifold V1 valve</i>	<i>Remove and inspect V1. Clean or replace if necessary (refer to parts manual)</i>
Deck will not lower	Machine in mechanical stops	Raise machine until safety lock arms release
	<i>Mainframe wiring damaged</i>	<i>Inspect mainframe wiring. Repair or replace if necessary (refer to parts manual)</i>
	Cabinet to mainframe lift hoses not connected or connected backwards	Connect or reconnect lift hoses. Hose with black band connects to coupler closest to porta-frame bulkhead mini-line receptacle
	<i>Bad V1 coil</i>	<i>Check for magnetic field at V1 coil. Replace if necessary (refer to parts manual)</i>
	Bad control manifold V1 valve	Remove and inspect V1. Clean or replace if necessary (refer to parts manual)
	<i>Bad V2 coil</i>	<i>Check for magnetic field at V2 coil. Replace if necessary (refer to parts manual)</i>

Troubleshooting - Cont.

Problem	Possible Cause	Possible Solution
Deck will not lower (cont.)	Bad control manifold V2 valve	Remove and inspect V2. Clean or replace if necessary (refer to parts manual)
	<i>Bad V4 coil</i>	<i>Check for magnetic field at V4 coil. Replace if necessary (refer to parts manual)</i>
	Contamination in control manifold V4 valve	Clean and inspect V4, Replace if necessary (refer to parts manual)
Deck will not tilt	Machine in mechanical stops	Raise machine until safety lock arms release
	<i>Pneumatic lines at porta-frame bulkhead reversed</i>	<i>Verify that natural pneumatic line is connected to top press-to-lock fitting on porta-frame bulkhead panel</i>
	Locking arms damaged	Inspect lock arms. Contact Chief Automotive service representative for repair or replacement
	<i>Unload bar damaged</i>	<i>Inspect unload bar. Replace if necessary (refer to parts manual)</i>
Towers roll hard	Outer track dirty	Clean outer track
	<i>Tower wheel bearings dirty</i>	<i>Clean wheel bearings with compressed air</i>
	Tower wheel bearings damaged	Replace tower wheel bearings (refer to parts manual)
	<i>Tower hook loose</i>	<i>Tighten tower hook bolts (refer to parts manual)</i>
	Inside tower rollers dirty	Clean inside tower rollers
	<i>Inside tower rollers damaged</i>	<i>Replace inside tower rollers (refer to parts manual)</i>
	Track damaged	Contact Chief Automotive service representative
Sure-Lock difficult to engage or disengage	Deck surface not clean	Clean deck and sure-lock
	<i>Outrigger shims out of adjustment</i>	<i>Contact Chief Automotive service representative</i>
	Tower hook shims out of adjustment	Contact Chief Automotive service representative
	<i>Tower driver bar off center</i>	<i>Recenter tower driver bar and retighten lock bolt (refer to parts manual)</i>
	Corrosion in tower bushings	Apply oil to tower side bushings
Sure-lock does not securely hold tower in place	Outrigger shims out of adjustment	Contact Chief Automotive service representative
	<i>Tower hook loose</i>	<i>Tighten tower hook bolts (refer to parts manual)</i>
	Sure-lock tower side bushings worn	Contact Chief Automotive service representative
	<i>Inside tower rollers damaged</i>	<i>Contact Chief Automotive service representative</i>

impulse-E/VHT Specifications

	<u>NARROW impulse-18' E/VHT</u>	<u>WIDE impulse-20' E/VHT</u>
Weight	5,000 lbs (2,270 kg)	6,350 lbs (2,890 kg)
Power Required	115 vac 20 amp dedicated line	115 vac 20 amp dedicated line
Hydraulic Power	10 tons	10 tons
Hydraulic Fluid	2.9 gal (11L)-SUS 215 Viscosity 100 degrees F (38 degrees C) 10W hydraulic fluid	2.9 gal (11L)-SUS 215 Viscosity 100 degrees F (38 degrees C) 10W hydraulic fluid
Radius of Pull	360 Degrees	360 Degrees
Controls	External cabinet with hand-held control unit	External cabinet with hand-held control unit
Deck Length	18' 0" (5,490mm)	19' 10" (6,050mm)
With ramps	19' 8" (6,000mm)	21' 10" (6,660mm)
Towers at one end with ramps	21' 8" (6,600mm)	24' 4" (7,400mm)
Towers on both ends	22' 0" (6,700mm)	24' 10" (7,570mm)
Deck Width	6' 9" (2,060mm)	7' 4" (2,240mm)
With towers extended to both sides	10' 8" (3,250mm)	12' 4" (3,760mm)
Width of treadways	0' 23-3/8" (595mm)	0' 26" (660mm)
Width between treadways	0' 33-1/2" (850mm)	0' 36" (915mm)
Tower Height	8' 4" (2,540mm)	8' 4" (2,540mm)
Clearance (recommended on all sides)	2' 6" (762mm)	2' 6" (762mm)
Working Heights	19" (485mm) 22-1/2" (570mm) 28-1/2" (720mm) 31" (790mm) 34-1/2" (880mm) 40" (1,016mm)	19" (485mm) 22-1/2" (570mm) 28-1/2" (720mm) 31" (790mm) 34-1/2" (880mm) 40" (1,016mm)
Tie Down Openings	172 178 with optional crossmember	192 198 with optional crossmember
Lift Capacity	10,000 lbs (4,535 kg)	10,000 lbs (4,535 kg)
Sound pressure level at Control Position	81 db (A)	81 db (A)
Optional:	Removable crossmember Additional towers (2)	Removable crossmember Additional towers (2)



**996 Industrial Drive
Madison, IN 47250
Phone: 800-445-9262
Fax: 866-275-0173**

www.chiefautomotive.com

**Chief reserves the right to alter product specifications
and/or package components without notice.**