

CUTTER AND SCISSORS

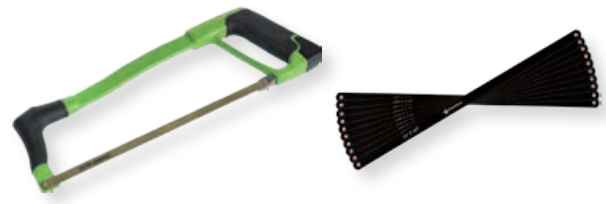

Professional cutters	180
Flexible cutters	180
Electricians' scissors	181
Multifunction scissors	181

HACKSAWS AND BLADES



Hacksaws with HSS Bi-metal blade	183
Mini hacksaws	183
Blades	183

BOLT CUTTERS AND SHEARS



Bolt cutters	182
Shears	182

FILES AND RASPS



Second cut files	184
Bastard cut files	184
Needle files	185
Rasps	185



TAPS AND DIES



Taps	186
Dies	187
Set of taps and dies	188
Tube drills and step drills	189

HOLE SAWS, ROTARY FILES



Hole saws	192
Accessories for hole saws	193
Rotary files	194
Grinding pencils	195

DRILLS



HSS drills	190
HSS-Tin 5% drills	191
HSS-Co 5% drills	191



Utility knife with retractable trapezoidal blade



CODE	L/mm	
FG 48	170	

Equipped with 5 blades

Foldaway knife with trapezoidal blade



CODE	L/mm	
FG 48/B	110-180	

Equipped with 3 blades

Kit of 10pcs blades for FG 48/L Blade's dimension: 0.5x18x60 mm

CODE	CONTENU	
FG 48/K12	12pz	

Utility knife with long blade

CODICE	L/mm	€/Pz
FG 48/L	164	6,00

Utility knife with long blade

CODE	L/mm	
FG 48/LG	16.7	

Kit of 12pcs blades for FG 48/L Blade's dimension: 0.5x18x100 mm

CODE	CONTENU	
FG 48/KL10	10pz	





Professional pen cutter

Equipped with 3 blades

CODE	L/mm	
FG 48/P	142	

10pcs blades' kit

CODE	
FG 48/PL	



Foldable knife with wire stripping notch

HRC: 52-54

CODE	L/mm	
FG 48/FK	121-207	



Electrician's scissors

CODE	L/mm	L/mm blade	Max opening	
FG 49	137	45	55mm	



Multi-purpose scissor with stainless steel blades

HRC: 52-54

CODICE	L/mm	L/mm blade	Max opening	
FG 49/L	200	87	151mm	



Multi-purpose scissor with wire stripper and saw-type blades

HRC: 52-54

CODE	L/mm	L/mm blade	CAPACITÉ	
FG 49/MU	203	52	1.0, 1.5, 2.0 mm ²	



Hose cutter with stainless steel blades

CODE	L/mm	CAPACITÉ	
FG 77/TT	226	3 - 36mm	



RUBBER HOSE



Bolt cutter

CODE	L/mm -"	CAPACITY	
FG 67/350	350 - 14"	3-10mm	
FG 67/450	450 - 18"	5-16mm	
FG 67/600	600 24"	8-22mm	
FG 67/750	750 - 30"	9-25mm	
FG 67/900	900 - 36"	10-26mm	

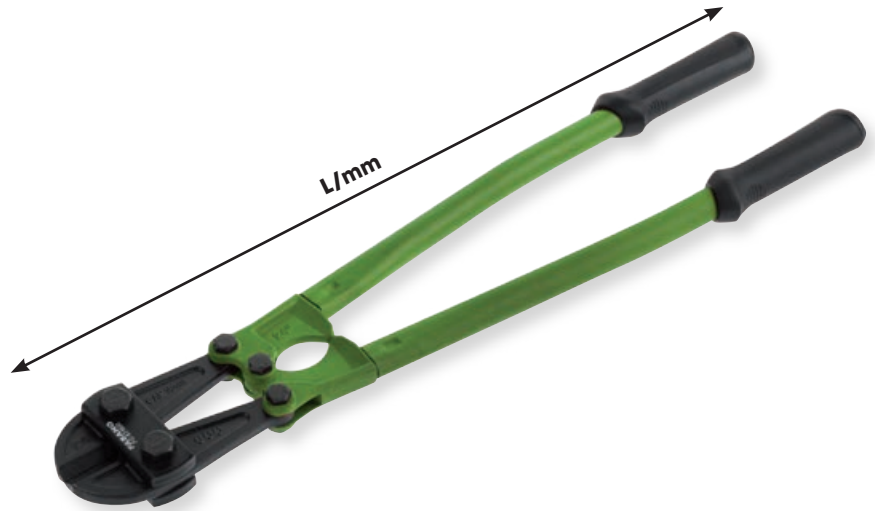

Tin snips straight wide blades

HRC: 58-61

CODE	L/mm	STEEL	INOX	
FG 49/HE200	200	0.53 mm	0.36 mm	
FG 49/HE250	250	0.78 mm	0.46 mm	
FG 49/HE300	300	0.94 mm	0.78 mm	
FG 49/HE350	350	1.24 mm	0.78 mm	

Compound leverage shears, straight blades
HRC: 60-62

CODE	L/mm	Max opening	
FG 49/CS	252	21mm	

STEEL: 0 -1.2mm
INOX: 0-0.7mmLeft cut leverage shears, curved blades
HRC: 60-62

CODE	L/mm	Max opening	
FG 49/CL	245	17mm	

STEEL: 0 -1.2mm
INOX: 0-0.7mmRight cut leverage shears, curved blades
HRC: 60-62

CODE	L/mm	Max opening	
FG 49/CR	245	17mm	

STEEL: 0 -1.2mm
INOX: 0-0.7mm



Ergonomic hacksaw with HSS Bi-Metal blade

CODE	L/mm	Lama mm	
FG 50/ME	402	300	

- adjustable blade 0° and 40°



Simple hacksaw with HSS Bi-Metal blade

CODE	L/mm	Lama mm	
FG 50/SE	402	300	

- système de tension de lame intégré



Simple hacksaw with HSS Bi-Metal blade

CODE	L/mm	Lama mm	
FG 50/PE	515	300	

Mini hacksaw with Carbon steel blade

CODE	L/mm	Lame mm	
FG 50/MS	270	150	

- adjustable blade 45°, 90°, 135°, 180°

Mini hacksaw with HSS Bi-Metal blade

CODE	L/mm	Lame mm	
FG 50/MN	405	130	

Mini hacksaw with HSS Bi-Metal blade

CODE	L/mm	Lame mm	
FG 50/MI	312	150	

Kit of blades

CODE	L/mm	MATÉRIEL	CONTENU	
FG 50/MSL	150	Carbonio	10pz	
FG 50/MIL	300	Carbonio	10pz	
FG 50/LBM	300	HSS Bi-metal	10pz	



Second cut files with handle - 8"

CODE	L/mm	FORME	
FG 80/8AR	200	RONDE	
FG 80/8AM	200	DEMI-RONDE	
FG 80/8AP	200	PLATE	
FG 80/8AT	200	TRIANGULAIRE	
FG 80/8AQ	200	CARRÉE	

Set of second cut files

CODE	COUPE	CONTENU	
FG 80/S5B	DEMI-DOUCE	5pz	



Soft form of 5pcs second cut files

CODE	CUT	CONTENT	
FG 100/62B	SECOND	5pz	

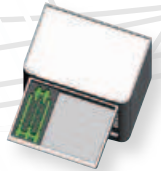

Plastic tray of 5pcs second cut files

CODE	CUT	CONTENT	
FG 102/62B	SECOND	5pz	



Bastard cut files with handle - 8"

CODE	L/mm	FORME	
FG 81/8AR	200	RONDE	
FG 81/8AM	200	DEMI-RONDE	
FG 81/8AP	200	PLATE	
FG 81/8AT	200	TRIANGULAIRE	
FG 81/8AQ	200	CARRÉE	



Set to bastard cut files

CODE	CUT	CONTENT	
FG 81/S5B	BASTARD	5pcs	



Soft form of 5pcs bastard cut files

CODE	CUT	CONTENT	
FG 100/62C	BASTARD	5pz	



Needle files with handle

CODE	L/mm	SHAPE	Minimum q.ty
FG 83/AR	160	ROUND	5pz
FG 83/AT	160	TRIANGLE	5pz
FG 83/AQ	160	SQUARE	5pz
FG 83/AM	160	HALF-ROUND	5pz
FG 83/AP	160	FLAT	5pz
FG 83/AW	160	WARDING	5pz



Set of needle files with handles in nylon pouch

CODE	CONTENU
FG 83/S6	6pz

Rasps with handle

CODE	L/mm	SHAPE
FG 82/RT	200	ROUND
FG 82/RST	200	HALF-ROUND
FG 82/RP	200	FLAT



Set of 3pcs rasps in carton box

CODE	CONTENT
FG 82/S3	3pz



SET OF 3pcs HSS TAPS - COARSE AND METRIC TREAD

DIN 352 - HRC: 63-66



CODE	Ø mm	■ mm	L1mm	L mm
FG 71/M3x0.5	3x0.5	3.5	11	40
FG 71/M4x0.7	4x0.7	3.5	13	45
FG 71/M5x0.8	5x0.8	6.0	16	48
FG 71/M6X1	6X1	6.0	19	50
FG 71/M7X1	7X1	6.0	19	50
FG 71/M8X1.25	8X1.25	6.0	22	56
FG 71/M10x1.5	10x1.5	7.0	24	70
FG 71/M12X1.75	12X1.75	9.0	29	75
FG 71/M14X2	14X2	11.0	30	80
FG 71/M16X2	16X2	12.0	32	80
FG 71/18x2.5	18x2.5	14.0	40	95
FG 71/M20X2.5	20X2.5	16.0	40	95
FG 71/M22X2.5	22X2.5	18.0	40	100
FG 71/M24X3	24X3	18.0	50	110

SET OF 3pcs HSS TAPS - FINE AND METRIC TREAD

DIN 2181 - HRC: 63-66



CODE	Ø mm	■ mm	L1mm	L mm
FG 72/M6x0.75	6x0.75	6.0	19	50
FG 72/M7X0.75	7X0.75	6.0	19	50
FG 72/M8X0.75	8X0.75	6.0	22	56
FG 72/M8X1	8X1	6.0	22	56
FG 72/M9X1	9X1	7.0	22	63
FG 72/M10X0.75	10X0.75	7.0	24	70
FG 72/M10x1	10x1	7.0	24	70
FG 72/M10X1.25	10X1.25	7.0	24	70
FG 72/M11X1	11X1	8.0	24	70
FG 72/M12X1	12X1	9.0	29	75
FG 72/M12X1.25	12X1.25	9.0	29	75
FG 72/M12X1.5	12X1.5	9.0	29	75
FG 72/M13X1.5	13X1.5	9.0	29	75
FG 72/M14x1	14X1	11.0	30	80

CODE	Ø mm	■ mm	L1mm	L mm
FG 72/M14X1.25	14X1.25	11.0	30	80
FG 72/M14X1.5	14X1.5	11.0	30	80
FG 72/M15X1.5	15X1.5	12.0	32	80
FG 72/M16X1	16X1	12.0	32	80
FG 72/M16x1.5	16x1.5	12.0	40	80
FG 72/M18X1.5	18X1.5	14.0	40	95
FG 72/M18X2	18X2	14.0	40	95
FG 72/M20X1.25	20X1.25	16.0	40	95
FG 72/M20X1.5	20X1.5	16.0	40	95
FG 72/M20X2	20X2	16.0	40	95
FG 72/M22X1.5	22X1.5	18.0	40	100
FG 72/M24X1	24X1	18.0	50	110
FG 72/M24X1.5	24X1.5	18.0	50	110
FG 72/M24X2	24X2	18.0	50	110

Hand tap holder with zinc cap - Din 1814



CODE	CAPACITY	Ø mm	L/mm
FG 72/GMM0	M1-M8	2-5mm	130
FG 72/GMM1	M1-M10	2-6.3mm	190
FG 72/GMM1.5	M1-M12	2.1-8mm	217
FG 72/GMM2	M4-M12	3-9mm	280
FG 72/GMM3	M5-M20	4.9-12mm	380
FG 72/GMM4	M9-M27	5.5-16mm	500
FG 72/GMM5	M13-M32	7-18mm	700

Ratchet tap holder - short model

CODE	M	BSW	L/mm
FG 72/GMC1	M3-M10	1/8-3/8	85
FG 72/GMC2	M5-M12	7/32-1/2	85

Ratchet tap holder - long model

CODE	M	BSW	L/mm
FG 72/GMC3	M3-M10	1/8-3/8	300
FG 72/GMC4	M5-M12	7/32-1/2	300



HSS DIE - COARSE AND METRIC TREAD

DIN223
HRC: 63-65

CODE	Ø mm		CODE	Ø mm	
FG 73/M3x0.5	20x5		FG 73/M12X1.75	38x14	
FG 73/M4x0.7	20x5		FG 73/M14X2	38x14	
FG 73/M5x0.8	20x7		FG 73/M16X2	45x18	
FG 73/M6x1	20x7		FG 73/M18X2.5	45x18	
FG 73/M7X1	25x9		FG 73/M20X2.5	45x18	
FG 73/M8X1.25	25x9		FG 73/M22X2.5	55x22	
FG 73/M10X1.5	30x11		FG 73/M24X3	55x22	



HSS DIE - FINE AND METRIC TREAD

DIN223 - HRC: 63-65



CODE	Ø mm		CODE	Ø mm		CODE	Ø mm	
FG 74/M6x0.75	20X7		FG 74/M11X0.75	30X11		FG 74/M18x1.5	45x14	
FG 74/M7X0.5	25X9		FG 74/M11X1	30X11		FG 74/M20x1.25	45x14	
FG 74/M8X0.75	25x9		FG 74/M12X0.75	38X14		FG 74/M20x1.5	45x14	
FG 74/M8X1	25x9		FG 74/M12X1	38X14		FG 74/M20x2	45x14	
FG 74/M9X0.75	25x9		FG 74/M12x1.25	38x14		FG 74/M21x1.5	45x14	
FG 74/M9X1	25x9		FG 74/M12x1.5	38x14		FG 74/M22x1.5	55x16	
FG 74/M9X1.25	25X9		FG 74/M14x1	38x14		FG 74/M24x1	55x16	
FG 74/M10X0.5	30X11		FG 74/M14x1.25	38x14		FG 74/M24x1.5	55X16	
FG 74/M10X0.75	30X11		FG 74/M14x1.5	38x14		FG 74/M24x2	55X16	
FG 74/M10X1	30x11		FG 74/M15x1	38x14				
FG 74/M10X1.25	30X11		FG 74/M16x1	45x14				
FG 74/M11X0.5	30X11		FG 74/M16x1.5	45x14				

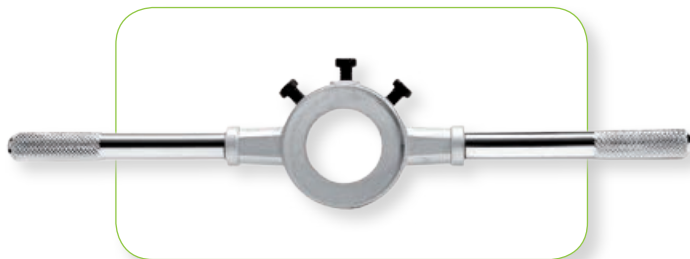

Die holder

DIN225

CODE	Ø mm	L/mm	
FG 74/GF16x5	16x5	160	
FG 74/GF20x5	20x5	200	
FG 74/GF20x7	20x7	200	
FG 74/GF25x9	25x9	224	
FG 74/GF30x11	30x11	280	
FG 74/GF38x14	38x14	315	
FG 74/GF45x18	45x18	450	
FG 74/GF55x22	55x22	560	
FG 74/GF65x25	65x25	630	



Combined drill for drilling-threading-deburring with 1/4" hexagon drive

HSS

CODE	Ø mm	L/mm	
FG 74/PM3x0.5	3x0.5	36	
FG 74/PM4x0.7	4x0.7	39	
FG 74/PM5x0.8	5x0.8	41	
FG 74/PM6x1	6x1	44	
FG 74/PM8x1.25	8x1.25	50	
FG 74/PM10x1.5	10x1.5	59	

Set of combined drills + accessory

CODE	CONTENT	
FG 74PM/S7	M3 - M10	





Set of 110pcs taps, dies and accessories

Coarse and fine thread

CODE	
FG 70/S110	

FG 71/M	FG 72/M	FG 73/M	FG 74/M	ACCESSORIES
2x0.04	6x0.75 12x1	2x0.4	6x0.75 12x1	FG 74/GF25x9
3x0.5	7x0.75 12x1.25	3x0.5	7x0.75 12x1.25	FG 74/GF8x14
4x0.7	8x0.75 12x1.5	4x0.7	8x0.75 12x1.5	FG 72/GMM1.5
5x0.8	8x1 14x1	5x0.8	8x1 14x1	FG 72/GMM3
6x1	9x0.75 14x1.25	6x1	9x0.75 14x1.25	FG 72/GMC1
7x1	9x1 14x1.5	7x1	9x1 14x1.5	
8x1.25	10x0.75 16x1	8x1.25	10x0.75 16x1	
9x1.25	10x1 16x1.5	9x1.25	10x1 16x1.5	
10x1.5	10x1.25 18x1.5	10x1.5	10x1.25 18x1.5	
11x1.5	11x0.75 18x2	11x1.5	11x0.75 18x2	
12x1.75	11x1	12x1.75	11x1	
14x2	11x1.25	14x2	11x1.25	
16x2	12x0.75	16x2	12x0.75	



SET OF 65pcs HSS TAPS + ACCESSORIES COARSE AND FINE TREAD / METRIC TREAD

FG 71/M...	FG 72/M...	FG 73/M...	FG 74/M...	ACCESSORIES
3 x 0.5	6 x 0.75	3 x 0.5	10 x 1.25	FG 72/GMM1.5
4 x 0.7	8 x 1	4 x 0.7	12 x 1.5	FG 72/GMM3
6 x 1	10 x 1.25	5 x 0.8	14 x 1.5	FG 72/GMC1
7 x 1	12 x 1.5	6 x 1	16 x 1.5	FG 72/GMC2
8 x 1.25	14 x 1.5	7 x 1	18 x 1.5	FG 74/GF25x9
10 x 1.5	16 x 1.5	8 x 1.25		FG 74/GF45x18
12 x 1.75	18 x 1.5	10 x 1.5		
14 x 2				
16 x 2				
18 x 2.5				
20 x 2.5				

CODE	
FG 70/S65	

SET OF 21pcs TAPS + HAND TAP HOLDER

Coarse and metric tread

CODE	CONTENT	
FG 71/S22	M3, 4, 5, 6, 8, 10, 12 FG 72/GMM1.5	



HSS TUBE DRILL

CODE	Ø mm	L/mm	
FG 80HSS/1	3 - 14	58	
FG 80HSS/2	6 - 20	70	
FG 80HSS/3	16 - 30.5	75	



Set of 3pcs HSS TUBE DRILLS

CODE	CONTENT	
FG 80HSS/S3	3 - 14 mm 6 - 20 mm 16 - 30.5 mm	

HSS STEP DRILL

CODE	Ømm	L/mm	S/mm	
FG 81HSS/1	4 - 12	65	1	
FG 81HSS/2	4 - 20	75	2	
FG 81HSS/3	4 - 30	100	2	



Set of 3pcs HSS STEP DRILLS

CODE	CONTENT	
FG 81HSS/S3	3 - 12 mm 4 - 20 mm 4 - 30 mm	



TWIST HSS DRILL WITH CYLINDRICAL SHANKS

ENTIRELY GROUND GLOSSY
- DIN 338



CODE	Ømm	L1 - L2	Min. Q.ty
FG 75/HSS0.5	0.5	6 - 22	10
FG 75/HSS1	1.0	12 - 34	10
FG 75/HSS1.25	1.25	16 - 38	10
FG 75/HSS1.5	1.5	20 - 43	10
FG 75/HSS1.75	1.75	22 - 46	10
FG 75/HSS2	2.0	24 - 49	10
FG 75/HSS2.25	2.25	27 - 53	10
FG 75/HSS2.5	2.5	30 - 57	10
FG 75/HSS2.75	2.75	33 - 61	10
FG 75/HSS3	3.0	33 - 61	10
FG 75/HSS3.1	3.1	36 - 65	10
FG 75/HSS3.2	3.2	36 - 65	10
FG 75/HSS3.25	3.25	39 - 70	10
FG 75/HSS3.5	3.5	39 - 70	10
FG 75/HSS3.75	4.0	39 - 70	10
FG 75/HSS4.0	4.0	43 - 75	10
FG 75/HSS4.1	4.1	43 - 75	10
FG 75/HSS4.2	4.2	43 - 75	10

CODE	Ømm	L1 - L2	Min. Q.ty
FG 75/HSS4.25	4.25	47 - 80	10
FG 75/HSS4.5	4.5	47 - 80	10
FG 75/HSS4.75	4.75	47 - 80	10
FG 75/HSS5	5.0	52 - 86	10
FG 75/HSS5.1	5.1	52 - 86	10
FG 75/HSS5.25	5.25	52 - 86	10
FG 75/HSS5.5	5.5	57 - 93	10
FG 75/HSS5.75	5.75	57 - 93	10
FG 75/HSS6	6.0	57 - 93	10
FG 75/HSS6.25	6.25	63 - 101	10
FG 75/HSS6.5	6.5	63 - 101	10
FG 75/HSS6.75	6.75	69 - 109	10
FG 75/HSS7	7.0	69 - 109	10
FG 75/HSS7.5	7.5	69 - 109	10
FG 75/HSS8	8.0	75 - 117	10
FG 75/HSS8.5	8.5	75 - 117	10
FG 75/HSS9	9.0	81 - 125	10

CODE	Ømm	L1 - L2	Min. Q.ty
FG 75/HSS9.5	9.5	81 - 125	10
FG 75/HSS10	10.0	87 - 133	10
FG 75/HSS10.5	10.5	87 - 133	10
FG 75/HSS11	11.0	94 - 142	10
FG 75/HSS11.5	11.5	94 - 142	10
FG 75/HSS12	12.0	101 - 142	10
FG 75/HSS12.5	12.5	101 - 151	05
FG 75/HSS13	13.0	101 - 151	05
FG 75/HSS14	14.0	108 - 160	05
FG 75/HSS15	15.0	114 - 169	05
FG 75/HSS16	16.0	120 - 178	05
FG 75/HSS17	17.0	125 - 184	04
FG 75/HSS18	18.0	130 - 191	04
FG 75/HSS19	19.0	135 - 198	04
FG 75/HSS20	20.0	140 - 205	04

NEW

NEW

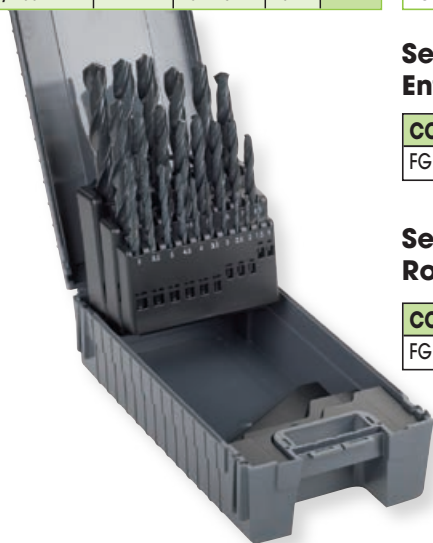

Set of 25pcs twist HSS drills with cylindrical shank
Entirely ground glossy

CODE	CONTENT
FG 75HSS/S25	1- 13mm

Set of 25pcs twist HSS drills with cylindrical shank
Rolled version

CODE	CONTENT
FG 75/S25	1- 13mm

Set of 170pcs twist HSS drills with cylindrical shank - Rolled version

CODE	CONTENT
FG 75/S170	0.5 - 10mm



Twist HSS drill with 13mm shank

- DIN 338

NEW

CODE	Ømm	L1 - L2	Min. Q.ty	
FG 75/HSS14	14.0	108 - 160	05	26,00
FG 75/HSS15	15.0	114 - 169	05	31,00
FG 75/HSS16	16.0	120 - 178	05	35,00

CODE	Ømm	L1 - L2	Min. Q.ty	
FG 75/HSS17	17.0	125 - 184	04	41,00
FG 75/HSS18	18.0	130 - 191	04	47,00
FG 75/HSS19	19.0	135 - 198	04	51,00
FG 75/HSS20	20.0	140 - 205	04	58,00

TWIST HSS-TIN 5% DRILL WITH CYLINDRICAL SHANKS ENTIRELY GROUND GLOSSY - DIN 338

CODE	Ømm	L1 - L2	Min. Q.ty
FG 75/TIN0.5	0.5	6 - 22	10
FG 75/TIN1	1.0	12 - 34	10
FG 75/TIN1.5	1.5	20 - 43	10
FG 75/TIN2	2.0	24 - 49	10
FG 75/TIN2.5	2.5	30 - 57	10
FG 75/TIN3	3.0	33 - 61	10
FG 75/TIN3.5	3.5	39 - 70	10
FG 75/TIN4	4.0	43 - 75	10

CODE	Ømm	L1 - L2	Min. Q.ty
FG 75/TIN4.5	4.5	47 - 80	10
FG 75/TIN5	5.0	52 - 86	10
FG 75/TIN5.5	5.5	57 - 93	10
FG 75/TIN6	6.0	57 - 93	10
FG 75/TIN6.5	6.5	63 - 101	10
FG 75/TIN7	7.0	69 - 109	10
FG 75/TIN7.5	7.5	69 - 109	10
FG 75/TIN8	8.0	75 - 117	10

CODE	Ømm	L1 - L2	Min. Q.ty
FG 75/TIN8.5	8.5	75 - 117	10
FG 75/TIN9	9.0	81 - 125	10
FG 75/TIN9.5	9.5	81 - 125	10
FG 75/TIN10	10.0	87 - 133	10
FG 75/TIN10.5	10.5	87 - 133	10
FG 75/TIN11	11.0	94 - 142	10
FG 75/TIN11.5	11.5	94 - 142	10
FG 75/TIN12	12.0	101 - 151	05
FG 75/TIN12.5	12.5	101 - 151	05
FG 75/TIN13	13.0	101 - 151	05



Set TWIST HSS-TIN 5% drills with cylindrical shank - entirely ground glossy

CODE	Pz	CONTENT
FG 75TIN/S13	13	1 - 6.5 x0,5mm
FG 75TIN/S19	19	1 - 10 x0,5mm
FG 75TIN/S25	25	1 - 13 x0,5mm



TWIST HSS-CO 5% DRILL WITH CYLINDRICAL SHANKS ENTIRELY GROUND GLOSSY - DIN 338

CODE	Ømm	L1 - L2	Min. Q.ty
FG 75/CO0.5	0.5	12 - 34	10
FG 75/CO1	1.0	12 - 34	10
FG 75/CO1.5	1.5	20 - 43	10
FG 75/CO2	2.0	24 - 49	10
FG 75/CO2.5	2.5	30 - 57	10
FG 75/CO3	3.0	33 - 61	10
FG 75/CO3.5	3.5	39 - 70	10
FG 75/CO4	4.0	43 - 75	10

CODE	Ømm	L1 - L2	Min. Q.ty
FG 75/CO4.5	4.5	47 - 80	10
FG 75/CO5	5.0	52 - 86	10
FG 75/CO5.5	5.5	57 - 93	10
FG 75/CO6	6.0	57 - 93	10
FG 75/CO6.5	6.5	63 - 101	10
FG 75/CO7	7.0	69 - 109	10
FG 75/CO7.5	7.5	69 - 109	10
FG 75/CO8	8.0	75 - 117	10

CODE	Ømm	L1 - L2	Min. Q.ty
FG 75/CO8.5	8.5	75 - 117	10
FG 75/CO9	9.0	81 - 125	10
FG 75/CO9.5	9.5	81 - 125	10
FG 75/CO10	10.0	87 - 133	10
FG 75/CO10.5	10.5	87 - 133	10
FG 75/CO11	11.0	94 - 142	10
FG 75/CO11.5	11.5	94 - 142	10
FG 75/CO12	12.0	101 - 151	05
FG 75/CO12.5	12.5	101 - 151	05
FG 75/CO13	13.0	101 - 151	05



Set TWIST HSS-CO 5% drills with cylindrical shank - entirely ground glossy

CODE	Pz	CONTENT
FG 75CO/S13	13	1 - 6.5 x0,5mm
FG 75CO/S19	19	1 - 10 x0,5mm
FG 75CO/S25	25	1 - 13 x0,5mm



HSS BI-METAL HOLE SAWS

Max cutting capacity: 38mm

HRC: 60

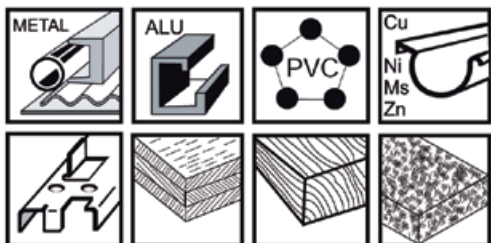

APPLICATIONS



CODE	Ømm	Inch.	H/ mm	RPM				
				Steel	Inox	Cast stees	Brass	Alumi-num
FG 78/HSS14	14	9/16"	45	580	300	400	790	900
FG 78/HSS16	16	5/8"	45	550	275	365	730	825
FG 78/HSS17	17	11/16"	45	500	250	330	665	750
FG 78/HSS19	19	3/4"	45	460	230	300	600	690
FG 78/HSS20	20	25/32"	45	425	210	280	560	635
FG 78/HSS21	21	13/16"	45	425	210	280	560	635
FG 78/HSS22	22	7/8"	45	390	195	260	520	585
FG 78/HSS24	24	15/16"	45	370	185	245	495	555
FG 78/HSS25	25	1"	45	350	175	235	470	525
FG 78/HSS27	27	1.1/16"	45	325	160	215	435	480
FG 78/HSS28	28	1.1/16"	45	300	150	200	400	450
FG 78/HSS29	29	1.1/8"	45	300	150	200	400	450
FG 78/HSS30	30	1.3/16"	45	285	145	190	380	425
FG 78/HSS32	32	1.1/4"	45	275	140	180	360	410
FG 78/HSS33	33	1.5/16"	45	260	135	175	345	390
FG 78/HSS35	35	1.3/8"	45	250	125	165	330	375
FG 78/HSS37	37	1.7/16"	45	240	120	160	315	360
FG 78/HSS38	38	1.1/2"	45	230	115	150	300	345
FG 78/HSS40	40	1.9/16"	45	220	110	145	290	330
FG 78/HSS41	41	1.5/8"	45	210	105	140	280	315
FG 78/HSS43	43	1.11/16"	40	205	100	135	270	305
FG 78/HSS44	44	1.3/4"	40	195	95	130	260	295
FG 78/HSS46	46	1.13/16"	40	190	95	125	250	285
FG 78/HSS48	48	1.7/8"	40	180	90	120	240	270
FG 78/HSS50	50	2"	40	170	85	115	230	255
FG 78/HSS51	51	2.1/16"	40	165	80	110	220	245
FG 78/HSS52	52	2.1/16"	40	165	80	110	220	245
FG 78/HSS54	54	2.1/8"	40	160	80	105	210	240

CODE	Ømm	Inch.	H/ mm	RPM				
				Steel	Inox	Cast stees	Brass	Alumi-num
FG 78/HSS57	57	2.1/4"	40	150	75	100	200	225
FG 78/HSS59	59	2.5/16"	40	145	75	100	195	225
FG 78/HSS60	60	2.3/8"	40	140	70	95	190	220
FG 78/HSS64	64	2.1/2"	40	135	65	90	180	205
FG 78/HSS65	65	2.9/16"	40	130	65	85	175	200
FG 78/HSS67	67	2.5/8"	40	130	65	85	170	195
FG 78/HSS68	68	2.11/16"	40	130	65	85	170	195
FG 78/HSS70	70	2.3/4"	40	125	60	80	160	185
FG 78/HSS73	73	2.7/8"	40	120	60	80	160	180
FG 78/HSS76	76	3"	40	115	55	75	150	170
FG 78/HSS79	79	3.1/8"	40	110	55	70	140	165
FG 78/HSS83	83	3.1/4"	40	105	50	70	140	155
FG 78/HSS86	86	3.3/8"	40	100	50	65	130	150
FG 78/HSS89	89	3.1/2"	40	95	45	65	130	145
FG 78/HSS92	92	3.5/8"	40	95	45	60	120	140
FG 78/HSS95	95	3.3/4"	40	90	45	60	120	135
FG 78/HSS98	98	3.7/8"	40	90	45	60	120	135
FG 78/HSS102	102	4"	40	85	40	55	110	130
FG 78/HSS105	105	4.1/8"	40	80	40	55	110	120
FG 78/HSS108	108	4.1/4"	40	80	40	55	110	120
FG 78/HSS111	111	4.3/8"	40	80	40	50	100	120
FG 78/HSS114	114	4.1/2"	40	75	35	50	100	105
FG 78/HSS121	121	4.3/4"	40	70	35	45	95	95
FG 78/HSS127	127	5"	40	65	30	45	90	90
FG 78/HSS133	133	5.1/4"	40	60	25	40	85	85
FG 78/HSS140	140	5.1/2"	40	60	25	40	85	85
FG 78/HSS146	146	5.3/4"	40	60	25	40	85	85
FG 78/HSS152	152	6"	40	55	25	35	75	75



Arbors for hole saws

CODE	FOR:	Ø mm	L/mm
FG 78/AL14	16 - 30 mm	6.35	54
FG 78/AL12	35 - 152 mm	6.35	70

Hss pilot drill

CODE	Ø mm	L/mm
FG 78/PC1	6.35	102.0





Spring for hole saw

CODE	L/mm	
FG 78/SP1	40.0	



Hss pilot drill

CODE	L/mm	
FG 78/PR1	300.0	

Set of 9pcs hole saws + accessories

	CONTENT	mm
01x	FG 78/HSS...	19, 22, 29, 35, 38, 44, 51, 57, 64
01x	FG 78/AL14	16 - 30
01x	FG 78/PC1	102x6.35
01x	FG 78/AD	32 - 51

CODE	
FG 78HHS/S13	



Set of 12pcs hole saws + accessories

CODE	CONTENT	mm	
FG 78HSS/S17	FG 78/HSS...	19, 22, 29, 35, 38, 44, 50, 51, 57, 64, 76, 83	
	FG 78/AL14	16 - 30	
	FG 78/AL12	35 - 152	
	FG 78/PR1	300.0	
	FG 78/PC1	102x6.35	
	FG 78/SP1	40.0	

Set of 8pcs cutting tools

CODE	CONTENT	
FG 49/S8	FG 78/HSS22, FG 78/HSS51, FG 78/AL14	
	FG 77/TT	
	FG 76/R1, FG 76/R2	
	FG 78/SP1	
	FG 49/MU	



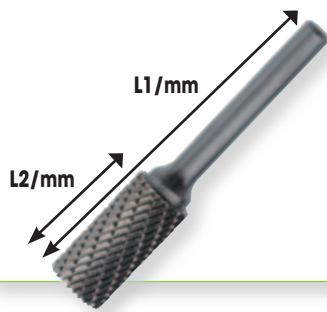

Rotary file for hard metal HM4

CODE	Ø/mm	L2/mm	L1/mm	
FG 80MD/ET6	6.0	16	50	
FG 80MD/ET12.7	12.7	25	70	

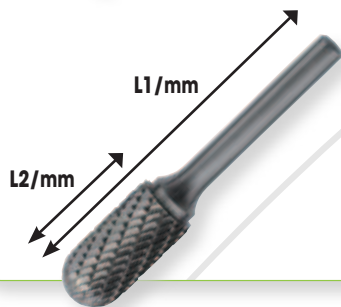

Rotary file for hard metal HM4

CODE	Ø/mm	L2/mm	L1/mm	
FG 80MD/ER6	6.0	16	50	
FG 80MD/ER12.7	12.7	25	70	

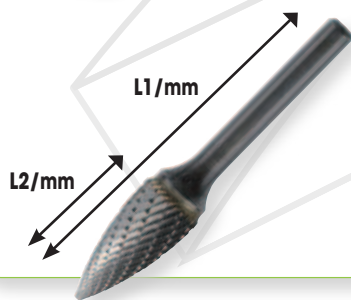

Rotary file for hard metal HM4

CODE	Ø/mm	L2/mm	L1/mm	
FG 80MD/SV6	6.0	16	50	
FG 80MD/SV12.7	12.7	26	70	

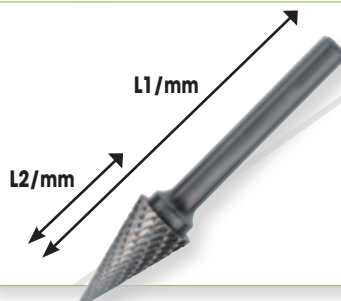

Rotary file for hard metal HM4

CODE	Ø/mm	L2/mm	L1/mm	
FG 80MD/EC6	6.0	19	50	
FG 80MD/EC12.7	12.7	22	70	

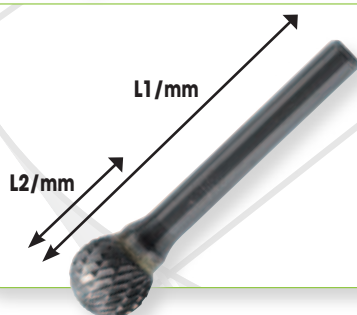

Rotary file for hard metal HM4

CODE	Ø/mm	L2/mm	L1/mm	
FG 80MD/CS6	6.0	16	50	
FG 80MD/CS12.7	12.7	25	56	

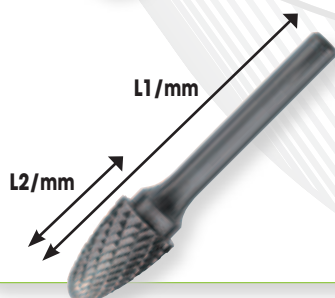

Rotary file for hard metal HM4

CODE	Ø/mm	L2/mm	L1/mm	
FG 80MD/AR6	6.0	16	50	
FG 80MD/AR12.7	12.7	19	63	

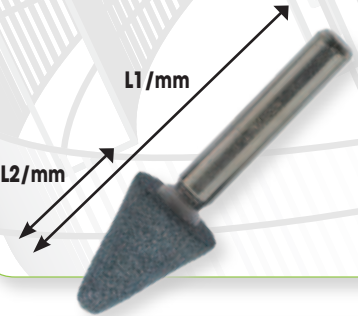

Grinding pencil - 6mm

CODE	Ø/mm	L1/mm	L2/mm	
FGA 338/MO1	6.0	50	20	
FGA 338/MO2	6.0	63	36	

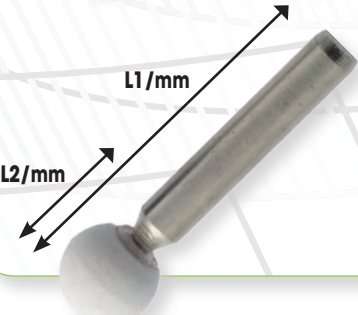

Grinding pencil - 6mm

CODE	Ø/mm	L1/mm	L2/mm	
FGA 338/MO3	6.0	45	11	
FGA 338/MO4	6.0	50	25	

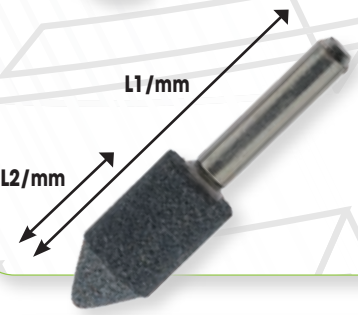

Grinding pencil - 6mm

CODE	Ø/mm	L1/mm	L2/mm	
FGA 338/MO5	6.0	53	26	
FGA 338/MO6	6.0	53	25	
FGA 338/MO7	6.0	53	25	

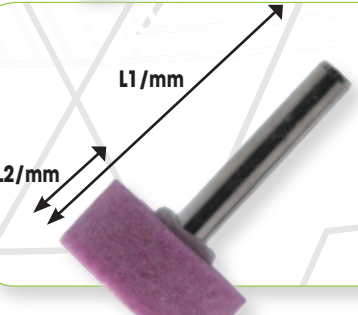

Grinding pencil - 6mm

CODE	Ø/mm	L1/mm	L2/mm	Ø/mm	
FGA 338/MO8	6.0	45	13	25	
FGA 338/MO9	6.0	45	15	10	

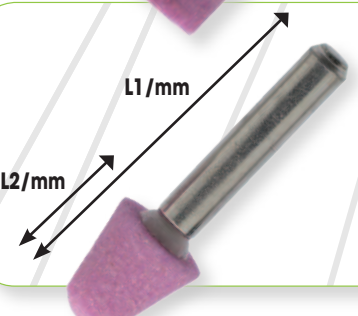

Grinding pencil - 6mm

CODE	Ø/mm	L1/mm	L2/mm	
FGA 338/MO10	6.0	45	15	

