

GOLIATH

USERS MANUAL



CHIEF'S LIMITED ONE-YEAR WARRANTY & LIABILITY

Chief Automotive Technologies warrants for one year from date of installation and/or purchase any components of its GOLIATH Repair System which do not perform satisfactorily due to defect caused by faulty material or workmanship. Chief's obligation under this warranty is limited to the repair or replacement of products which are defective and which have not been misused, carelessly handled, or defaced by repair or repairs made or attempted by others.

CHIEF AUTOMOTIVE TECHNOLOGIES DOES NOT ASSUME RESPONSIBILITY FOR ANY DEATH, INJURY OR PROPERTY DAMAGE RESULTING FROM THE OPERATOR'S NEGLIGENCE OR MISUSE OF THIS PRODUCT OR ITS ATTACHMENTS. CHIEF MAKES NO WRITTEN, EXPRESS OR IMPLIED WARRANTY WHATSOEVER OF MERCHANTABILITY OR FITNESS FOR A PARTICULAR PURPOSE OR OTHERWISE REGARDING THE EQUIPMENT OR ANY PART OF THE PRODUCT OTHER THAN THE LIMITED ONE-YEAR WARRANTY STATED ABOVE.

Chief GOLIATH

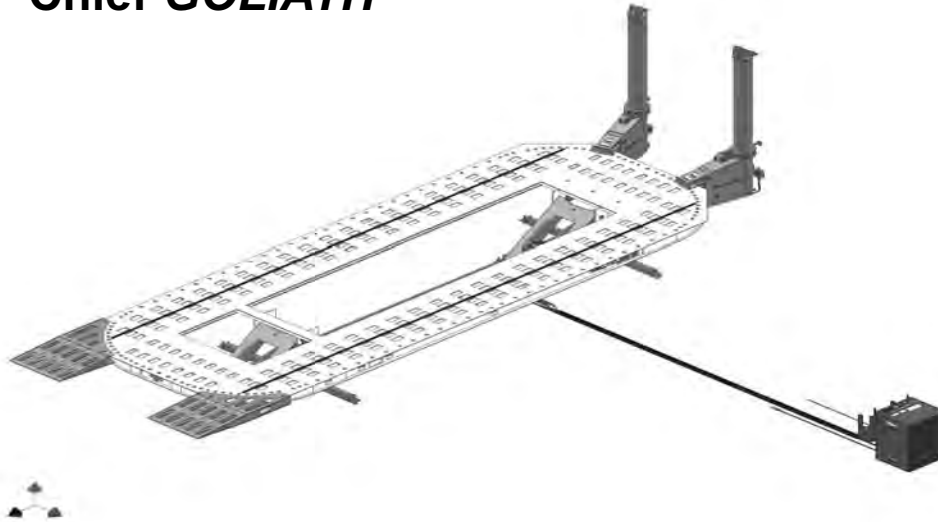

STOP! This machine is shipped without hydraulic oil in the reservoir. Fill the reservoir to within 1" (25 mm) of the fill port using SUS 215 viscosity @ 100°F (38°C) 10W hydraulic oil prior to operating.

This users manual is written to familiarize operators with the safe and efficient operation of the Chief GOLIATH. The GOLIATH machine features unibody and full frame repair capabilities with 360 degree pulling access around the vehicle.

Two towers are provided with the GOLIATH and up to two more can be added as optional equipment. Each tower mounts to the bottom plate of the mainframe. A unique tower roller design allows easy movement around the machine and a "Sure-Lock" force clamp secures the tower to the mainframe when making a pull. Each tower is equipped with one 10-ton hydraulic ram operated by an electric over hydraulic pump. The machine is hydraulically positioned at various working heights, and tilts hydraulically for either drive-on or winch-on positioning of vehicles.

NOTE: Illustrations shown in this manual may vary slightly from actual product.

This manual is not intended to replace Chief Automotive Training. For information concerning Training, contact Chief Automotive Technologies

IMPORTANT:

1. DO NOT attempt to operate the Chief GOLIATH without first reading this entire manual.
2. Complete safety information is highlighted throughout this manual and is identified by: 
This safety alert symbol identifies safety information. Operator injury could result if these CAUTION notes are not followed.
3. Qualified service personnel must check operational capacity of the GOLIATH system prior to its initial use and at intervals of no more than one year. Contact Chief Automotive Technologies or contact your authorized Chief Automotive Technologies representative.
4. Persons operating the GOLIATH repair system must be at least 18 years of age, must be trained in the operation of the GOLIATH system, and must have demonstrated their qualifications to the employer. They must also be specifically assigned to operate the GOLIATH system by the employer and this assignment must be made in writing.

IMPORTANT SAFETY INSTRUCTIONS

When using your garage equipment, basic safety precautions should always be followed, including the following:

1. Read all instructions.
2. Care must be taken as burns can occur from touching hot parts.
3. Do not operate equipment with a damaged cord or if the equipment has been dropped or damaged - until it has been examined by a qualified service person.
4. Do not let a cord hang over the ledge of the table, bench, or counter or come in contact with hot manifolds or moving fan blades.
5. If an extension cord is necessary, a cord with a current rating equal to or more than that of the equipment should be used. Cords rated for less current than the equipment may overheat. Care should be taken to arrange the cord so that it will not be tripped over or pulled.
6. Always unplug equipment from electrical outlet when not in use. Never use the cord to pull the plug from the outlet. Grasp plug and pull to disconnect.
7. Let equipment cool completely before putting away. Loop cord loosely around equipment when storing.
8. To reduce the risk of fire, do not operate equipment in the vicinity of open containers of flammable liquids (gasoline).
9. Keep hair, loose clothing, fingers and all parts of the body away from moving parts.
10. To reduce the risk of electric shock, do not use on wet surfaces or expose to rain.
11. Use only as described in this manual. Use only manufacturer's recommended attachments.
12. ALWAYS WEAR SAFETY GLASSES. Everyday eyeglasses only have impact resistant lenses, they are not safety glasses.

SAVE THESE INSTRUCTIONS

General Safety Tips

General

-  DO NOT operate this machine unless:
- 1) You are authorized in writing by your employer.
 - 2) All towers are properly secured to machine.
 - 3) Vehicle's wheels are blocked and parking brake is set.
 - 4) Load is 12,000 lbs or less.
 - 5) Field of motion of load carrying device is free of persons and obstructions.

 Persons operating the GOLIATH repair system must be at least 18 years of age, must be trained in the operation of GOLIATH system, and must have demonstrated their qualifications to the employer.

 DO NOT attempt to operate the GOLIATH pulling system without first reading this entire manual.

 Always wear safety glasses when using the GOLIATH machine or any of its accessories.

 Maintain a free space of 20 inches (50cm) minimum around all moving parts and pinch points on machine.

Optional Crossmember

 DO NOT use optional crossmember as a step.

 DO NOT use optional crossmember to make angular pushes or pulls.

 During removal and reinstallation of optional crossmember, hold crossmember firmly to support its weight. Use a helper if needed. Following installation, install support pins at each end of crossmember to prevent accident disengagement.

 To Avoid Damage to the lift assemblies or mainframe, crossmember must be installed and located properly when raising or lowering equipment

Collar

 To avoid accidental dropping of tower collar, tighten collar locking knob and/or lower collar to bottom of tower.

 Collar locking knob must be tightened before removing tower chain from vehicle.

Tower Movement



WARNING

Fully engage "Sure-Lock" force clamp with pinning hole on mainframe to prevent tower movement during the pull or during a raising or lowering procedure.



When pushing tower, keep one hand on tower lever and the other on the tower pipe above the collar. Also, keep hands away from all pinch points...i.e. roller assemblies on bottom mainframe plate and force clamp pinning location on top mainframe plate.



When engaging "Sure-Lock" force clamp, keep hands away from all pinch points...i.e. roller assemblies on bottom mainframe plate and force clamp pinning location on top mainframe plate.

NOTE: Hoses may need to be disconnected when moving towers around the front and rear of machine.

Pulling



WARNING!

To avoid severe personal injury to yourself and others: DO NOT position yourself close to, or in line with chains, clamps, or other accessories while pressure is applied to this system.



To prevent personal injury from flying objects:

- Check all bolts, nuts and clamps for deformation or elongation prior to each use.
- Deformed or elongated materials must be replaced.
- If materials look deformed, they are deformed. Replace them.



Remove twist in chain before applying pressure to the chain.

Raise / Lower Machine



When raising or lowering machine, secure towers to front of mainframe. The "Sure-Lock" force clamps must firmly engage pinning holes at that location and tower levers must be down



Lifting of persons is prohibited.











Keep feet and objects clear of mainframe when lowering machine.

General Safety Tips (continued)



-  To Avoid Personal Injury or Damage to Equipment:
 - Before operating the machine make sure:
 - Persons and objects are clear of machine
 - Hoses and other objects are free of the lift legs.
 - Oil spills must be cleaned up immediately to prevent slipping.
 - Hoses on the floor can create a tripping hazard.

Loading / Unloading Machine







Prior to driving or winching vehicle on or off the machine make sure loading ramps are installed correctly.

-  When driving or winching a vehicle on or off machine, use helper to guide you. If vehicle's brakes are inoperable, use a Chief Winch and refer to instructions packaged with that accessory.
-  Immediately after positioning vehicle on mainframe, put vehicle in park (if automatic transmission), apply vehicles emergency brake, and have helper install wheel chocks at "front" of front tire and at "rear" of rear tire. Install wheel chocks as close to the tires as possible to prevent vehicle movement and keep wheel chocks installed whenever vehicle is not anchored to mainframe.
-  Position vehicle far enough onto mainframe so that wheels do not rest on loading ramps. DO NOT use ramps to lift or hold a load off of the floor. Remove ramps before raising machine.
-  Before lowering machine, put vehicle in park (if automatic transmission), apply vehicles parking brake, and install wheel chocks. Then check to make sure loading ramps are installed correctly.
-  DO NOT run over air hoses or hydraulic lines when loading or unloading vehicles.
-  DO NOT exceed the machine's 12,000 lbs. (5,443 kg.) lifting capacity.
-  When raising or lowering machine with vehicle aboard, DO NOT walk behind rear of machine.
-  Always install wheel chocks when raising or lowering machine with a vehicle aboard.

Chain

-  The 1/2" tower chain is proof tested to 28,000 lbs. (124kN).
-  To avoid personal injury or damage to property, DO NOT:
 - Heat chain or hook while repairing vehicle. 600 degrees F (316 degrees C) of heat on chain will weaken it.
 - Tip load chain hook.
 - Pull with twisted chain links.

Hydraulics

-  Keep pumps far away from excessive heat or flames. The surrounding temperature should not exceed 122° F (50° C).
-  Always release hydraulic pressure before disconnecting hydraulic hoses.
-  If pump fails to shut off, disconnect electric supply and contact an authorized Chief Automotive Technologies Service Representative.
-  All components must be replaced with Chief Automotive Technologies authorized replacement parts.
-  Improper handling and/or modification of parts is forbidden and may cause a hazardous situation for the user. Such action immediately voids the warranty and releases the manufacturer from all liability.
-  Keep pump in upright position. DO NOT turn pump upside down or lay on its side.
- 
 1. Fill pump reservoir with all cylinders retracted and deck in lowest working position. (See Maintenance Section - page 15.)
 2. DO NOT overfill pump reservoir.

Operational Capacity

-  Qualified service personnel must check operational capacity of GOLIATH system prior to its initial use and at intervals of no more than one year. Contact Chief Automotive Technologies or contact your authorized Chief Automotive Technologies representative.

Optional Steps / Ladders

-  Use only approved steps and ladders when working on or around this equipment.

Hydraulic System Components

General

The Chief GOLIATH system is powered by an electrically operated hydraulic pump which is controlled by a remote control switch. Refer to the GOLIATH Parts Manual (Chief #451004) for component detail.

Hydraulic pressure is distributed to tower cylinders, auxiliary cylinders, and lift cylinders. The flow of hydraulic fluid to tower and auxiliary cylinders is controlled by individual valves located in each auxiliary line. The flow of hydraulic fluid to the lift cylinders is controlled by an electric switch mounted on the pump cabinet top panel. Hydraulic pressure is monitored by gauges mounted on the towers.

NOTE: Although the GOLIATH is a low pressure system, it builds hydraulic pressure quickly. Be aware of this quick reaction when making pulls or lifting vehicles.

Important:

Tower cylinders and auxiliary cylinders can be operated either simultaneously (with equal hydraulic pressure) or individually. The lift cylinders must not be operated while any tower or auxiliary cylinders are operating. Whenever using the hydraulic system, close all valves where hydraulic pressure is not required.



CAUTION: To avoid personal injury or damage to property: When disconnecting hydraulic hose from quick coupler, some fluid spillage may occur. Always clean up any hydraulic fluid spillage from floor or work area.

Initial Setup

The GOLIATH requires a compressed air supply to activate the safety lock releases. Before using the GOLIATH, it is necessary to install a customer supplied air coupler. The GOLIATH cabinet is equipped with a 1/4" Female NPT port on the back. (See Figure 1.)

The GOLIATH cabinet must be connected to the mainframe manifold. First insert the tilt and overload cord to the port-frame bulkhead receptacle. The cord is keyed so it will only connect one way. Hand-tighten the retaining collar. Next connect the black pneumatic line to the lower bulkhead fitting and the natural pneumatic line to the top fitting. (To connect the pneumatic lines, firmly push the hose into the fitting until it is firmly seated.) Finally, connect the front and rear lift hydraulic lines. The line marked with the black heat shrink tape connects to the coupler closest to the pneumatic fittings. (See Figure 2.)



Figure 1



Figure 2

Pump Usage

STOP! This machine is shipped without hydraulic oil. Fill the reservoir to within 1" (25 mm) of the fill port using SUS 215 viscosity @ 100°F (38°C) 10W hydraulic oil prior to operating.

1. To activate hydraulic pump to apply pressure to system to raise machine or towers, depress "UP" button on the hand-held control unit. The pump will build hydraulic pressure in the system to activate lift, tower, or auxiliary hydraulic cylinders.
2. To disengage the hydraulic pump, release "UP" button on hand-held control unit. (See Figure 3.) This action stops the flow of hydraulic oil to the system being operated: However, the system holds existing hydraulic pressure.
3. To release hydraulic pressure, depress the "DOWN" button on the hand-held control unit. (See Figure 4.) This will release the hydraulic pressure in the system and return hydraulic oil to the pump reservoir.

CAUTION: To prevent damage to the pump and hydraulic cylinders, DO NOT operate pump when cylinders are fully extended. (If possible, stop supplying pressure before cylinders reach their full extension.)



Figure 3



Figure 4

Towers

The GOLIATH repair system is equipped with two pulling towers that can be positioned 360 degrees around the machine. The system can accommodate up to two additional towers. All towers feature telescoping heads, adjustable collars, and a unique roller assembly that not only secures the tower to the bottom of the machine but also allows for 360 degree movement around the machine.

Also unique to this system are the “Sure-Lock” force clamps that secure towers to circular pinning holes along the outer edge of the mainframe. The force clamps secure towers to the mainframe while removing stress from the roller assemblies.

Tower pulls can be set up quickly and are controlled by a hand-held pendant, which controls the flow of hydraulic pressure, and individual tower valves which control the flow of oil to each tower. Lateral and elevated pulling angles can be made or changed in just a fraction of a minute.

 **CAUTION:** The 1/2 inch (13mm) tower chain is proof tested to 28,000 lbs. (124kN).

To Operate Towers

1. Step on “Sure-Lock” release handle to unlock “Sure-Lock” force clamp from mainframe. (See Figure 5.)
2. Rotate “Sure-Lock” lock handle forward to fully open Sure-Lock. (See Figure 6.)
3. Push tower to desired location on machine. (See Figure 7.)

 **CAUTION:** When pushing tower, keep one hand on “Sure-lock” lock handle and other hand on tower pipe above collar. Also, keep hands away from all pinch points...i.e. roller assemblies on bottom of mainframe plate and force clamp pinning locations on top mainframe plate.



Figure 5



Figure 6



Figure 7

To Operate Towers (continued)

4. To secure tower to mainframe, rotate “Sure-lock” lock lever back and down to engage “Sure-Lock” force clamp with mainframe pinning hole. (See Figure 8.) Fully lock “Sure-Lock” by stepping on lock lever. “Sure-Lock” force clamp is fully engaged when outer tower rollers are raised above the outer track. (See Figure 9.)

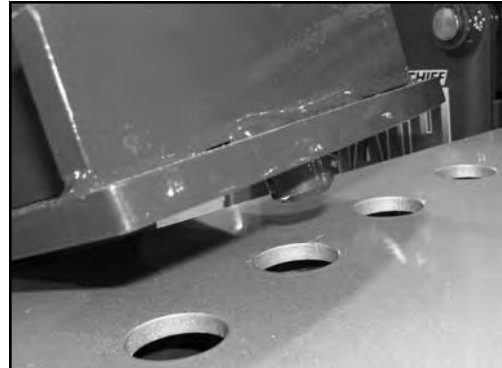

Figure 8

WARNING

Fully engage “Sure-Lock” force clamp with pinning hole on mainframe to prevent tower movement during the pull or during a raising or lowering procedure.

- CAUTION:** When engaging “Sure-Lock” force clamp, keep hands away from all pinch points...i.e. roller assemblies on bottom mainframe plate and force clamp pinning location on top mainframe plate.



Figure 9

5. To adjust slack tower chain, grip chain on each side of the tower. Lift out on tail of chain until it is approximately 45 degrees from tower. Then disengage chain from tower head and pull chain to either increase or decrease amount of slack. (See Figure 10.)
6. Support collar with one hand while loosening collar locking knob with opposite hand. Then position collar approximately three inches (75mm) above desired pulling height and retighten collar locking knob. (See Figure 11.)
7. Let tower chain hang free momentarily to remove twist. Then without twisting chain, attach hook to the vehicle. Pull on tail end of chain to remove slack (See Figure 12.) and then lower collar.

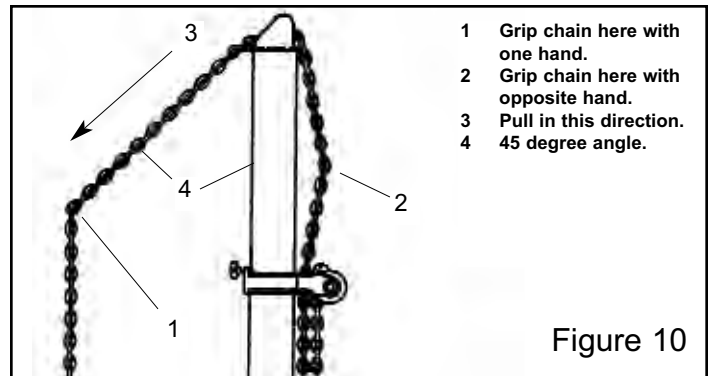

Figure 10

IMPORTANT: Remove twist from chain before lowering collar. Make sure that chain links between collar roller and hook align.

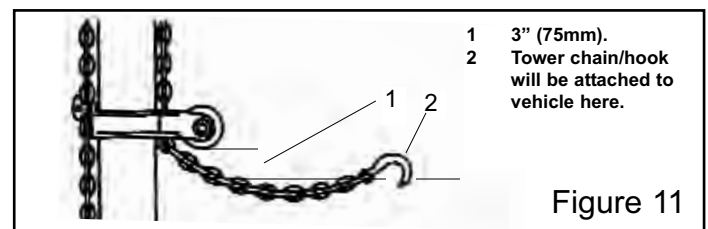

Figure 11

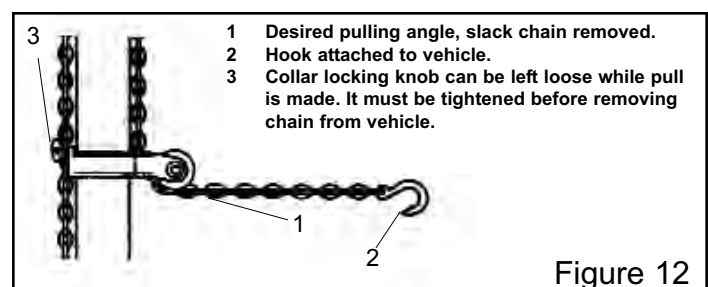

Figure 12

To Operate Towers (continued)

8. Attach pump's hydraulic hose to tower ram's quick coupler. (See Figure 13.)
9. To operate pump, follow usage procedures on page 5.

CAUTION:

1. To prevent damage to tower assembly, pulls must not exceed a 45 degree angle from tower base. (See Figure 14.)
2. To avoid personal injury or damage to equipment, DO NOT:
 - Heat chain hook while repairing vehicle. 600 degrees F (316 degrees C) of heat on chain will weaken it.
 - Tip load chain hook.
 - Pull with twisted chain links.

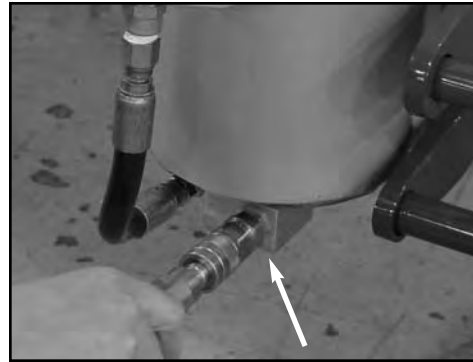



Figure 13

 **Warning**

To avoid severe personal injury to yourself and others: DO NOT position yourself close to, or in line with chains, clamps, or other accessories while pressure is applied to this system.

IMPORTANT:

1. DO NOT tighten collar locking knob while pressure is applied to system because it will be impossible to loosen the knob without pressure on the system.
 2. DO NOT wrap tower chain around track nor attach tower hook to track. Damage to track will impede tower usage.
10. When tower is no longer needed, disconnect hydraulic hose from tower ram's quick coupler, remove tower chain and hook from vehicle and store collar using one of the two methods shown in Figures 15 and 16.

CAUTION:

1. Collar locking knob must be tightened before removing tower chain and hook from vehicle.
2. Collar locking knob must be tight when collar is not in use.
3. Store collar at bottom of tower pipe or support collar with tower chain.

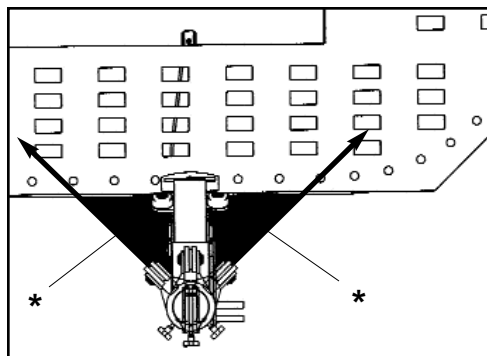

* Pulling Angle Must Not Exceed 45 Degree Range From Tower Base.

Figure 14

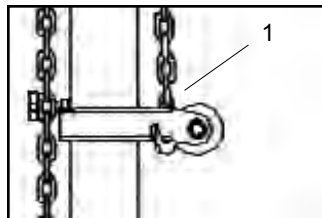

Figure 15

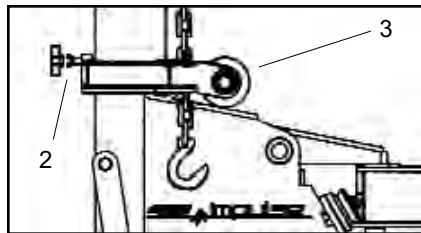

Figure 16

- 1 Collar supported by Tower Chain.
- 2 When collar and chain are stored this way, collar locking knob must be tightened before removing tower chain and hook from vehicle.
- 3 Collar rests on tower base.

Optional Crossmember

General

An optional crossmember is available for the *impulse* system. The crossmember (See Figure 17.) mounts to the inside edges of the treadway and can be moved forward or rearward as needed. The crossmember does not lock to the machine; however, support pins (See Figure 19.) prevent it from being accidentally disengaged.

The primary use of the crossmember is to support perpendicular pulls and pushes. In both instances, the auxiliary ram must be positioned perpendicular with top or bottom of crossmember.

To install the crossmember, hold it secure while rotating it into position. (See Figure 18.) Both ends of the crossmember must engage top mainframe plate. Then secure support pins (See Figure 19.) at each end of the crossmember.

CAUTION:

1. DO NOT use movable crossmember as a step.
2. DO NOT use movable crossmember as a base to make a hydraulic pull or push unless auxiliary ram is positioned perpendicular (90 degrees) with top or bottom of crossmember.
3. Each time crossmember is removed from mainframe and reinstalled, reinstall support pins at each end of the crossmember to prevent accidental disengagement.
4. DO NOT make angular pulls or pushes from the crossmember.

Reverse Usage - Optional Crossmember

If additional height is required for lifting high ground clearance vehicles, the crossmember can be turned upside down to provide a higher platform. (See Figure 20.) Bridging the treadways in this fashion provides an additional 5 inches of height.

CAUTION:

1. When crossmember is installed as shown in Figure 20, use extreme caution.
2. Use this setup only when mainframe is in level position.
3. Center crossmember evenly from side to side.
4. Remove crossmember before lowering machine.
5. Use this setup for perpendicular lifting only. DO NOT use this setup for any type of pull.
6. DO NOT position yourself close to or underneath the crossmember when lifting the vehicle.
7. Take caution to position crossmember when raising and lowering machine so that it does not damage the lift arm or pump.

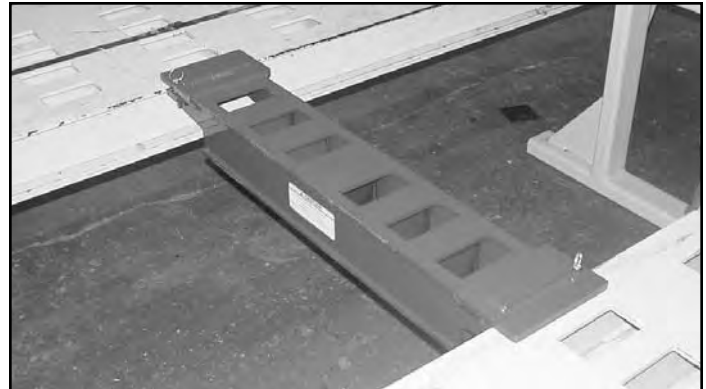

Figure 17



Figure 18

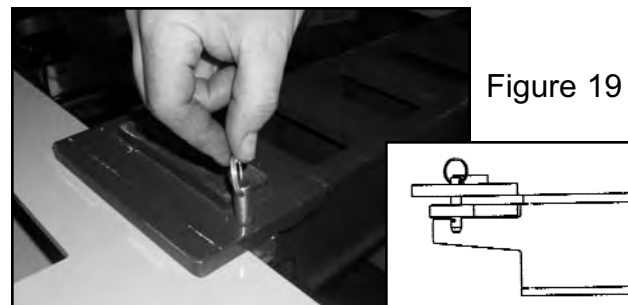

Figure 19

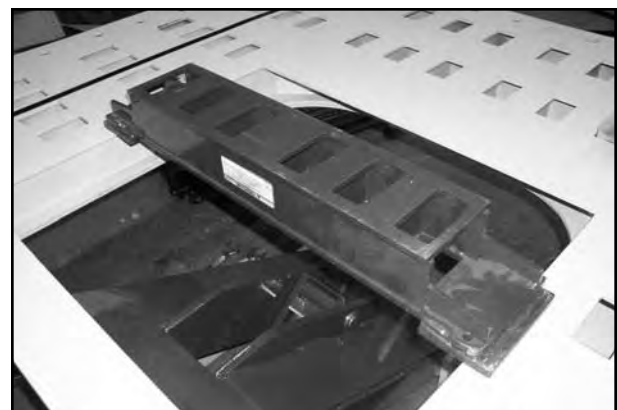

Figure 20

Lowering / Raising Machine

General

When lowering or raising a machine with a vehicle aboard observe the following precautions.

CAUTION:

1. When driving or winching vehicle on or off machine, use a helper to guide you. (See Figure 21.) If vehicle's brakes are inoperable, use a Chief Winch and refer to instructions packaged with that accessory.
2. When vehicle is on mainframe, all wheels must clear the loading ramps. (See Figure 22.) DO NOT attempt to lift machine with vehicle's wheels on the loading ramps. Remove ramps before raising machine.
3. Immediately after positioning vehicle on mainframe, put vehicle in park (if automatic transmission), and apply vehicles emergency brake. Continue to press brake pedal until helper installs wheel chocks (See Figure 23.) at "front" and "rear" of machine.
4. Prior to lowering machine, put vehicle in park (if automatic transmission), apply vehicles emergency brake, and install wheels chocks at front of front tires and rear of rear tires Then install loading ramps at rear of machine.
5. Keep vehicles wheels blocked during raising and lowering procedures and whenever vehicle is not anchored to mainframe.
6. When raising or lowering machine with vehicle aboard, DO NOT walk behind machine.
7. DO NOT exceed 12,000 lbs. (5,443 kg) lifting capacity of GOLIATH system.



Figure 21

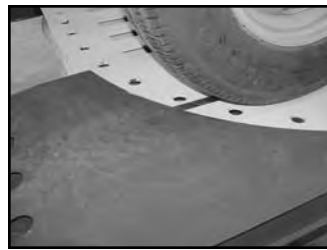

Figure 22



Figure 23

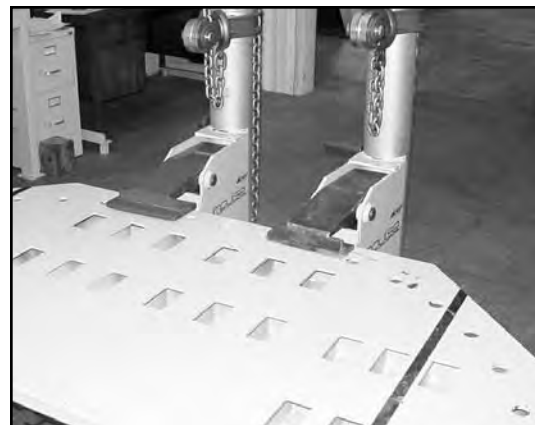

Figure 24

To Lower Machine For Loading

IMPORTANT: Observe preceding precautions when lowering machine with vehicle aboard.

1. Position towers at front of machine and secure the "Sure-Lock" force clamps to front pinning holes. (See Figure 24.)
2. Install loading ramps at rear of machine. (See Figure 25.)

NOTE: Loading Ramp pins must engage loading ramp pinning holes at rear corners of machine. (See Figure 25 Inset.)



Figure 25

* Loading Ramp Pinning Holes On Mainframe

3. Turn off all auxiliary line valves or disconnect all tower and auxiliary cylinders from system. (See Figure 26.)
4. Turn lift switch on pump cabinet to “ON” position. (See Figure 27.)
5. Raise machine until it is level and both safety lock arms are released.
6. Activate lock arm release by depressing and holding the brass button on the pump cabinet. (See Figure 28.)
7. Depress and hold the “DOWN” button on the hand-held control unit. The machine will automatically tilt into the loading position. (See Figure 29.)

CAUTION:

1. Before lowering machine, clear all obstacles from under and around machine.
2. DO NOT allow anyone or anything to ride on machine or be under machine during lowering procedures.
3. Position optional cross-member immediately ahead of rear fixed crossmember to avoid damage to the machine.



Figure 26



Figure 27



Figure 28



Figure 29

To Raise Machine After Loading

1. Turn off all auxiliary line valves or disconnect all tower and auxiliary cylinders from system. (See Figure 30.)
2. Turn lift switch on pump cabinet to "ON" position. (See Figure 31.)
3. Activate pump by depressing and holding "UP" button on hand-held control unit. Rear lift will rise until machine is level. Once machine is level, both lifts will rise together. (See Figure 32.)
4. After machine is above desired working height, release "UP" button on hand-held control unit to stop flow of hydraulic fluid from pump. Depress and hold "DOWN" button on hand-held control unit to lower machine into mechanical stops. (See Figure 33.)



Figure 30

⚠ CAUTION:

1. Before raising machine, verify that vehicle parking brake is set and automatic transmission is in park (if equipped).
2. DO NOT walk behind machine during raising procedures.
3. Install wheel chocks at front of front tire and rear of rear tire.



Figure 31



Figure 32



Figure 33

Adjust Working Heights

The GOLIATH has six (6) working heights from 19 inches (480mm) to 40 inches (1010mm).

To Raise Machine Working Height

1. Turn off all auxiliary line valves or disconnect all tower and auxiliary cylinders from system. (See Figure 34.)
2. Turn lift switch on pump cabinet to "ON" position. (See Figure 35.)
3. Activate pump by depressing and holding "UP" button on hand-held control unit. Raise machine until both lifts are above desired working height. (See Figure 36.)
4. Depress and hold "DOWN" button on hand-held control unit to lower machine into mechanical stops. (See Figure 37.)



Figure 34



Figure 35

To Lower Machine Working Height

1. Turn off all auxiliary line valves or disconnect all tower and auxiliary cylinders from system. (See Figure 34.)
2. Turn lift switch on pump cabinet to "ON" position. (See Figure 35.)
3. Activate pump by depressing and holding "UP" button on hand-held control unit. Raise machine until both lock arms are released. (See Figure 36.)
4. Disengage safety lock arms by depressing and holding "UNLOCK" button on pump cabinet. (See Figure 38.)
5. Depress and hold the "DOWN" button on hand-held control unit until machine is slightly above desired working height. (See Figure 37.)
6. Release "UNLOCK" button on pump cabinet to reengage safety lock arms. Continue to depress "DOWN" button on hand-held control unit until machine settles into locks.



Figure 36



Figure 37



Figure 38

Machine Maintenance

Check And Inspect

These components should be checked prior to use and anytime a problem is suspected.



CAUTION: To avoid personal injury when performing any maintenance function, always wear safety glasses and safety shoes.

Tower Chains, Tie-Down Chains

The tower chains/hooks and tie-down chains/hooks supplied with the Chief GOLIATH are high quality, high strength chains/hooks. If replacement is required, purchase only the original Chief product from an authorized Chief Automotive representative.



CAUTION: To avoid personal injury or damage to property:

- DO NOT Heat chain or hook while repairing vehicle - 600 degrees F (316 degrees C) of heat on chain will weaken it.
- DO NOT Tip load chain hook. Tip loading chain hook will stress hook beyond its designed capability and could cause hook to fail.
- DO NOT Pull with twisted chain links. Pulling with twisted links will stress chain links beyond their designed capability and could cause chain to fail.

Tower chains must be inspected for wear, nicks, gouges, stretched and bent links. If found, replace chain.

Tower chain hooks must be inspected for twist and stretched openings. If found, replace them.

Loading Ramps

Inspect loading ramps making sure loading ramp pins mate with pinning holes at rear of machine each time mainframe is raised or lowered.

Tower Rollers

Inspect inside and outside tower roller wheels for damage. The inside and outside roller bearings are lubrication free. Use compressed air to clean. DO NOT lubricate.

Power and Control Cords

Inspect power and control cords for worn insulation or other damage. If found, replace cord(s).

Cleaning and Lubricating

These components should be cleaned and lubricated as specified for trouble free operation and extended service. When lubricating use the following:

Oil — Use 30 weight motor oil for all components requiring oil.

Grease — Use a SUS750 Lithium type grease such as lubricate #630-2 for all components requiring grease.

Tower Heads

Clean tower heads annually.

1. Remove tower chain from tower head.
2. Remove tower head from tower pipe.
3. Clean dirt from tower head pipe and where tower head pipe rubs on inside of tower pipe.
4. Apply grease to tower head pipe.
5. Reinstall tower head and tower chain.

Collars

Clean and lubricate collars monthly.

1. Use compressed air to blow out dirt or dust that collects between collar ears and rollers.



CAUTION: Wear safety glasses while using compressed air to blow out dirt and dust.

2. Place a few drops of oil on roller pin between roller and collar ears (each side). Then turn roller a few times. Roller must turn freely.

Eliminating Air In Hydraulic System

All air has been removed from hydraulic system at the factory, but if hydraulic system is opened to replace a system component, it is necessary to bleed air from system prior to using it.

Bleeding Air In System At Tower Cylinder

1. Connect auxiliary line to tower cylinder and open auxiliary line valve.
2. Remove tower head and chain.
3. Fully extend tower cylinder by depressing and holding "UP" button on hand-held pendant until tower gauge shows 5 tons of pressure on system.
4. While holding rag over the top of the cylinder to prevent oil spray, use a 3/16" T-handle allen wrench, loosen cylinder top bolt 1/2 turn.
5. Rapid, side-to-side motion of the T-handle may be necessary to unseat the seal washer at the top of the cylinder.



CAUTION: Wear safety glasses to protect eyes from hydraulic oil in the event it squirts past rag.

6. Trapped air or trapped air/oil mixture (indicated by foam in the oil) should escape from top of cylinder. Wipe up any escaping oil with rag.
7. When cylinder is completely bled, only clean oil should escape from top of cylinder.

NOTE: It may be necessary to tighten top cylinder bolt and repressurize the system to 5 tons and repeat procedure.

8. Replace tower head and chain. Lower tower cylinder and refill reservoir to within 1" of fill port with all cylinders in retracted position.

Machine Maintenance (cont.)

Refill Hydraulic Fluid Reservoir

The hydraulic pump contains 2.9 gallons (11 liters) of hydraulic oil. When refilling or adding oil, fill to within 1" (25mm) of fill port using SUS 215 viscosity @ 100°F (38°C) 10W Hydraulic Oil.

Caution:

1. Fill pump reservoir with all cylinders retracted and deck at lowest working height.
2. DO NOT overfill pump reservoir.

Lift & Port-a-frame Assembly

All lift leg and porta-frame pivot points are permanently lubricated and do not require maintenance except for occasional cleaning.

Outer Track

Using compressed air, blow dirt and debris from outer track. If necessary, use stiff brush to remove build-up of dust and paint on outer track surface.

Visually inspect outer track for damage. Although small dents or upsets in the outer track may not affect the operation of the tower, they might indicate tower adjustment is necessary.

Sure-Lock

With normal use, the pivots on the Sure-Lock clamping system should stay free of dirt and operate smoothly and quietly. Extended periods of non-use or damp environments may adversely affect the operation of the Sure-Lock.

Use compressed air to blow dirt and debris from Sure-Lock pivot points. Apply a few drops of oil to Sure-Lock pivot pin and handle shaft pivots and work mechanism.

NOTE: It may be necessary to remove the handle shaft retainer bolt and washer to lubricate both sides of the handle shaft. Refer to Parts Manual exploded view for details on removal of handle shaft retainer components.

 **Caution:** Wear safety glasses while using compressed air to blow out dirt and dust.

The rotational motion of the Sure-Lock handles is transmitted to the Sure-Lock linkage via a 1/4" key. The key is retained by a 1/4-20 bolt. Verify that the bolt is tightened correctly.

Visually inspect the internal Sure-Lock linkage to verify that the Tower Linkage Driver bar is centered on the Sure-Lock handle shaft. With the Sure-Lock clamp in the locked position, inspect the engagement of the tower float linkage bars to the handle shaft.

Tower Rollers

Using compressed air, blow dirt and debris from the tower outside wheel assemblies. Visually inspect the bolts retaining the outside wheels to the tower weldment and the outside roller guard for damage.

Verify that the four bolts retaining the tower hook to the inside end of the 360 tower are not loose. Verify that the two bolts holding the tower outrigger block are tight.

NOTE: Refer to Parts Manual for detailed exploded views of referenced parts. Contact Chief Automotive with any questions regarding the usage or maintenance of the GOLIATH system.

Leveling Machine

1. Position towers at front of machine and secure the Sure-Lock force clamps to front pinning holes.
2. Raise machine to top working height and settle into mechanical stops.
3. Place level across front stabilizer bar and adjust left and right leveling bolts until front bar is level. (See Figures 39 & 40.)
4. Place level on right longitudinal tube. Adjust right rear leveling bolt until longitudinal tube is level. (See Figures 41 & 42.)
5. Place level on left longitudinal tube. Adjust left rear leveling bolt until longitudinal tube is level. (See Figures 43 & 42.)
6. Adjust inside leveling bolts until inside leveling feet contact floor. Then adjust an additional 1/4 turn. (See Figure 44.)

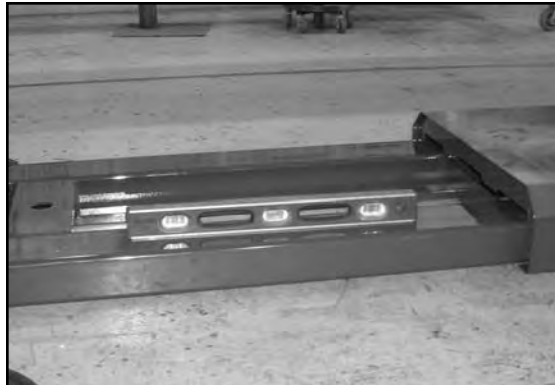

Figure 41



Figure 42



Figure 39



Figure 43

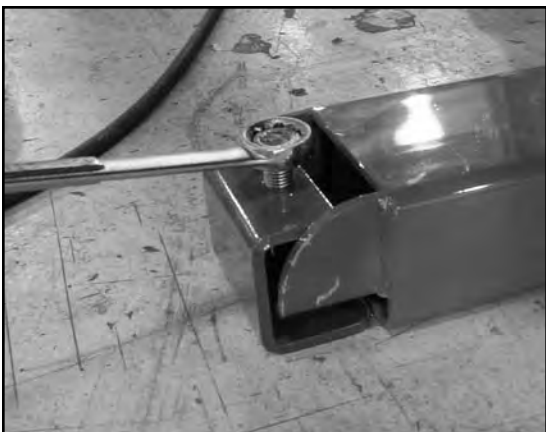

Figure 40



Figure 44

Troubleshooting

Problem	Possible Cause	Possible Solution
Pump will not run	Power cord disconnected	Plug in power cord
	<i>Circuit breaker tripped or blown fuse</i>	<i>Reset circuit breaker or replace fuse</i>
	Blown control board fuse	Remove and inspect fuse. Replace if necessary
	<i>Pendant not connected</i>	<i>Connect pendant to pump cabinet</i>
	Bad motor start relay	Replace motor start relay. Contact Chief Automotive service representative for replacement
	<i>Power cord damaged</i>	<i>Inspect power cord for damage. Contact Chief Automotive service representative for repair or replacement if necessary</i>
	Bad pendant	Inspect pendant. Contact Chief Automotive service representative for repair or replacement if necessary
	<i>Damaged pendant cord</i>	<i>Inspect pendant cord for damage. Contact Chief Automotive service representative for repair or replacement if necessary</i>
Pump will not build pressure or builds pressure slowly	Hydraulic fluid low	Fill reservoir to within 1" of fill port with SUS215 Viscosity @ 100 ° F (38°C) 10W hydraulic oil with all cylinders in retracted position
	<i>Contamination in control manifold startup valve</i>	<i>Remove and clean valve. Contact Chief Automotive service representative</i>
	Bad control manifold startup valve coil	Check for magnetic field at V4 coil. Contact Chief Automotive service representative for replacement if necessary. (Refer to parts manual)
	<i>Contamination in pump unload valve</i>	<i>Remove and inspect pump unload valve. Contact Chief Automotive service representative.</i>
Pump will not hold pressure	Hydraulic fluid leak	Check hoses, fittings and quick couplers for leaks. Tighten or replace if necessary
	<i>Contamination in control manifold check valve</i>	<i>Clean and inspect check valve. Replace if necessary. (refer to parts manual)</i>
	Contamination in control manifold V3 valve	Clean and inspect V3 valve. Replace if necessary (refer to parts Manual)
	<i>Contamination in pump unload valve</i>	<i>Remove and inspect pump unload valve. (Refer to parts manual). Contact Chief Automotive service representative</i>
Pump stalls or will not start under pressure	Facility wiring inadequate	Rewire facility to comply with local electrical code. Add dedicated line with 30 amp breaker
	<i>Extension cord too long or wire gauge too small</i>	<i>Use extension cord rated for 25 amps at 120 volts with ground wire up to 25 feet (7.5m) long</i> IMPORTANT: Extension cord use is not recommended. If used, extension cords must meet standards (listed above) and be used only on a short term basis
Tower cylinder jumps	Air in hydraulic system	Bleed hydraulic system
Tower cylinder will not extend	<i>Auxiliary line valve closed</i>	<i>Open auxiliary line valve one turn</i>
	Auxiliary line not connected to tower	Connect auxiliary line to tower
	<i>Pump will not build pressure</i>	<i>See pump problems above</i>
	Lift switch turned on	Turn off lift switch
Tower cylinder will not retract	<i>Auxiliary line valve closed</i>	<i>Open auxiliary line valve one turn</i>
	Auxiliary line not connected to tower	Connect auxiliary line to tower
	<i>Contamination in control manifold unload</i>	<i>Clean and inspect V3. Replace if necessary. (refer to parts manual)</i>
	Directional valve "DOWN" coil not working	Replace coil. Contact Chief Automotive service representative

Troubleshooting (continued)

Problem	Possible Cause	Possible Solution
Rear lift will not raise	Lift switch off	Turn lift switch "ON"
	<i>Auxiliary line valve open</i>	<i>Close all auxiliary line valves</i>
	Too much weight at rear of machine	Move vehicle forward on deck
	<i>Cabinet to mainframe hydraulic hoses not connected or connected backwards</i>	<i>Verify that black marked coupler on cabinet to machine hydraulic hose is connected to rear coupler on port-a-frame bulkhead</i>
	Cabinet to mainframe control cord not	Reconnect cabinet to mainframe control cord. Inspect cord for damage. Contact Chief Automotive for repair or replacement if necessary
	<i>Pump not building pressure</i>	<i>See pump troubleshooting</i>
	Contamination in control manifold rear lift valve	Remove and inspect V2 valve. Contact Chief Automotive for repair or replacement if necessary
<i>Bad rear lift valve coil</i>	<i>Check for magnetic field at V2 coil. Contact Chief Automotive for repair or replacement if necessary</i>	
Front lift will not raise	Lift switch off	Turn lift switch ON
	<i>Auxiliary line valve open</i>	<i>Close auxiliary line valves</i>
	Tilt switch not operating	Inspect tilt switch for damage. Contact Chief Automotive for repair or replacement if necessary
	<i>Machine overloaded in front</i>	<i>Move vehicle rearward on deck</i>
	Cabinet to mainframe hydraulic hoses not connected or connected backwards	Verify that black marked coupler is attached to correct coupler on port-a-frame bulkhead
Towers roll hard	<i>Dirt on outer track</i>	<i>Clean outer track</i>
	Dirt in outer tower roller bearings	Clean outer tower roller bearings
	<i>Tower shimmed incorrectly</i>	<i>Re-shim tower. Contact Chief Automotive service representative</i>
	Damaged inner roller	Replace inner roller. Contact Chief Automotive service representative
	<i>Damaged track</i>	<i>Repair track. Contact Chief Automotive service representative</i>
Sure-Lock difficult to engage	Dirt on deck	Clean deck
	<i>Dirt in Sure-Lock pivots</i>	<i>Clean Sure-Lock pivots. Apply a few drops of oil to pivot and operate Sure-Lock mechanism</i>
	Sure-Lock out of adjustment	Re-shim Sure-Lock. Contact Chief Automotive service representative
Sure-Lock difficult to disengage	<i>Dirt in Sure-Lock pivots</i>	<i>Clean Sure-Lock pivots. Apply a few drops of oil to pivots and operate Sure-lock mechanism</i>
	Sure-Lock out of adjustment	Re-shim Sure-Lock. Contact Chief Automotive service representative
Collars jump under load	<i>Improper fit between collar and tower pipe</i>	<i>Refit collar. Contact Chief Automotive service representative</i>

GOLIATH Specifications

Weight (2-Tower)	7,100 lbs (3,220 kg)
Weight (3-Tower)	7,750 lbs. (3,515 kg)
Power Required	120 vac, 60 Hz, 20 amp Single Phase Dedicated Line
Hydraulic Power	10 Tons
Hydraulic Fluid	2.9 gal (11L)-SUS 215 Viscosity 100 degrees F (38 degrees C) 10W hydraulic fluid
Radius of Pull	360 Degrees
Controls	External cabinet with hand-held control unit
Deck Length	22' (6,706 mm)
Maximum Length (Footprint)	28' 6" (8,687 mm)
Deck Width	7'8" (2,337mm)
Maximum Width (Footprint)	11' 8" (3,556 mm)
Treadway Width	2' 4" (711mm)
Width between treadways	0' 36" (915mm)
Tower Height	8' 4" (2,540mm)
Maximum Height	9' 4" (2,840 mm)
Pulling Force Per Tower	10 Tons (at the hook)
Clearance (recommended on all sides)	2' 6" (762mm)
Working Height (Floor to Top of Deck)	Six Stops From 19" to 40" (483 mm - 1,016mm)
Tie Down Openings	272 280 with optional crossmember
Lift Capacity	12,000 lbs (5,400 kg)
Optional:	Removable crossmember Additional towers (2)



**996 Industrial Drive
Madison, IN 47250
Phone: 800-445-9262
Fax: 866-275-0173**

www.chiefautomotive.com

**Chief reserves the right to alter product specifications
and/or package components without notice.**