

# Chief impulse - *Tilt*

## USERS MANUAL







## **CHIEF'S LIMITED ONE-YEAR WARRANTY & LIABILITY**

Chief Automotive Technologies, Inc. warrants for one year from date of installation and/or purchase any of its products which do not perform satisfactorily due to defect caused by faulty material or workmanship. Chief's obligation under this warranty is limited to the repair or replacement of products which are defective and which have not been misused, carelessly handled, or defaced by repair or repairs made or attempted by others.

**CHIEF AUTOMOTIVE TECHNOLOGIES, INC. DOES NOT ASSUME RESPONSIBILITY FOR ANY DEATH, INJURY OR PROPERTY DAMAGE RESULTING FROM THE OPERATOR'S NEGLIGENCE OR MISUSE OF THIS PRODUCT OR ITS ATTACHMENTS. CHIEF MAKES NO WRITTEN, EXPRESS OR IMPLIED WARRANTY WHATSOEVER OF MERCHANTABILITY OR FITNESS FOR A PARTICULAR PURPOSE OR OTHERWISE REGARDING THE EQUIPMENT OR ANY PART OF THE PRODUCT OTHER THAN THE LIMITED ONE-YEAR WARRANTY STATED ABOVE.**

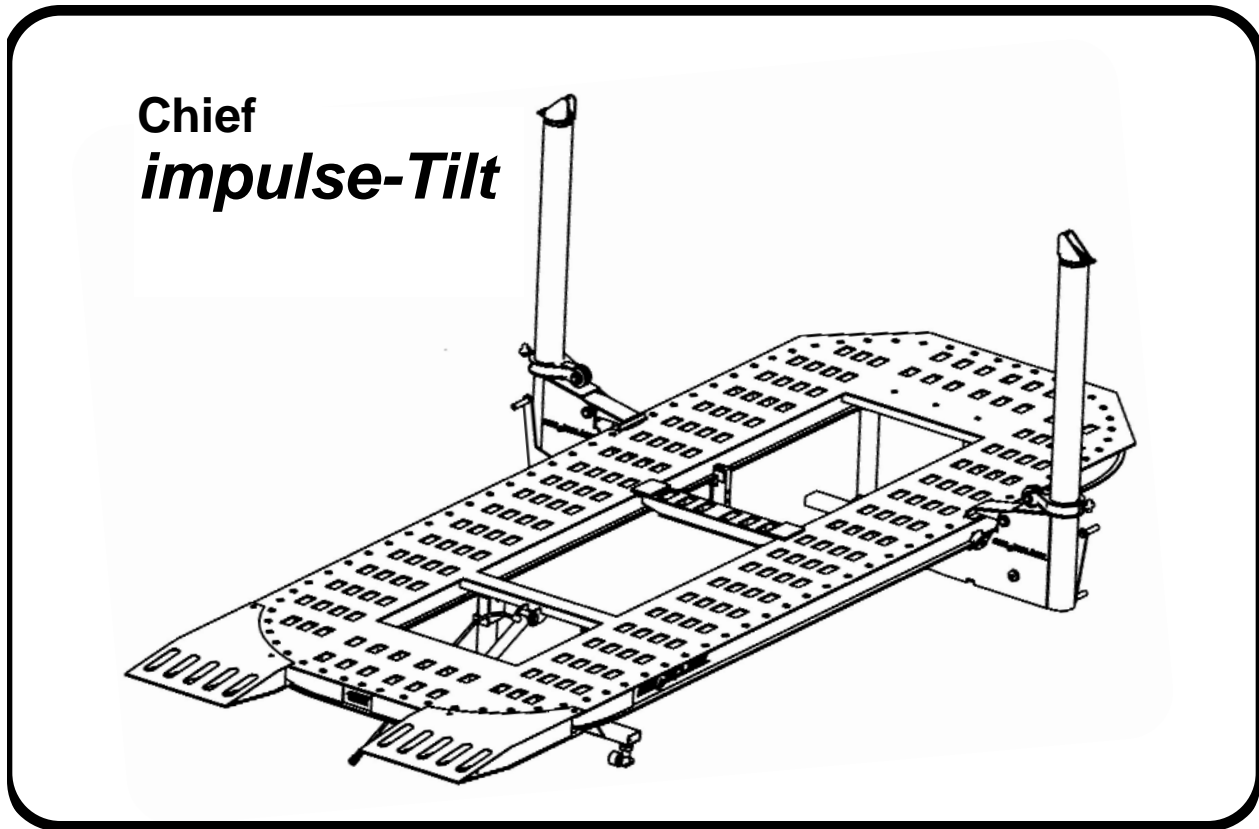

This owners manual is written to familiarize operators with the safe and efficient operation of the Chief *impulse-Tilt*. The *impulse-Tilt* machine features unibody and full frame repair capabilities with 360 degree pulling access around the vehicle.

Two towers are provided with the *impulse-Tilt* and up to three more can be added as optional equipment. Each tower mounts to the bottom plate of the mainframe. A unique tower roller design allows easy movement around the machine and a "Sure-Lock" force clamp secures the tower to the mainframe when making a pull. Each tower is equipped with one 10-ton hydraulic ram operated by an air over hydraulic foot pump. The machine tilts hydraulically for either drive on or winch positioning of the vehicle.

**NOTE:** Illustrations shown in this manual may vary slightly from actual product.

This manual is not intended to replace Chief Automotive Training. For information concerning Training, contact Chief Automotive Technologies.

**IMPORTANT:**

1. DO NOT attempt to operate the Chief *impulse-Tilt* without first reading this entire manual.
2. Complete safety information is highlighted throughout this manual and is identified by:  
 This safety alert symbol identifies safety information. Operator injury could result if these CAUTION notes are not followed.
3. Qualified service personnel must check operational capacity of the Chief *impulse-Tilt* system prior to its initial use and at intervals of no more than one year. Contact Chief Automotive Technologies or contact your authorized Chief Automotive Technologies representative.
4. Persons operating the Chief *impulse-Tilt* repair system must be at least 18 years of age, must be trained in the operation of the *impulse-Tilt* system, and must have demonstrated their qualifications to the employer. They must also be specifically assigned to operate the *impulse-Tilt* system by the employer and this assignment must be made in writing.

## General Safety Tips

### General



DO NOT operate this machine unless:

- 1) You are authorized in writing by your employer.
- 2) All towers are properly secured to machine.
- 3) Vehicle's wheels are blocked and parking brake is set.
- 4) Load is 6,000 lbs or less.
- 5) Field of motion of load carrying device is free of persons and obstructions.



Persons operating the *impulse-Tilt* repair system must be at least 18 years of age, must be trained in the operation of *impulse-Tilt* system, and must have demonstrated their qualifications to the employer.



DO NOT attempt to operate the *impulse-Tilt* pulling system without first reading this entire manual.



Always wear safety glasses when using the *impulse-Tilt* machine or any of its accessories.



DO NOT move machine if vehicle is on it.



Maintain a free space of 20 inches (50cm) minimum around all moving parts and pinch points on machine.

### Optional Crossmember



DO NOT use optional crossmember as a step.



DO NOT use optional crossmember to make angular pushes or pulls.



During removal and reinstallation of optional crossmember, hold crossmember firmly to support its weight. Use a helper if needed. Following installation, insert support pins at each end of crossmember to prevent accident disengagement.

### Collar



To avoid accidental dropping of tower collar, tighten collar locking knob and or lower collar to bottom of tower.



Collar locking knob must be tightened before removing tower chain from vehicle.

When pushing tower, keep one hand on tower lever

### Tower Movement



#### **WARNING**

Fully engage "Sure-Lock" force clamp with pinning hole on mainframe to prevent tower movement during the pull or during a raising or lowering procedure.



and the other on the tower pipe above the collar. Also, keep hands away from all pinch points...i.e. roller assemblies on bottom mainframe plate and force clamp pinning location on top mainframe plate.



When engaging "Sure-Lock" force clamp, keep hands away from all pinch points...i.e. roller assemblies on bottom mainframe plate and force clamp pinning location on top mainframe plate.

### Pulling

To prevent personal injury from flying objects:



#### **WARNING**

To avoid severe personal injury to yourself and others: DO NOT position yourself close to, or in line with chains, clamps, or other accessories while pressure is applied to this system.



- Check all bolts, nuts and clamps for deformation or elongation prior to each use.
- Deformed or elongated materials must be replaced.
- If materials look deformed, they are deformed. Replace them.

Remove twist in chain before applying pressure to the chain.



### Raise / Lower Machine

When raising or lowering machine, secure towers to front of mainframe. The "Sure-Lock" force clamps must firmly engage pinning holes at that location and tower levers must be down . Lifting of persons is prohibited.











Keep feet and objects clear of mainframe when lowering machine..





## General Safety Tips (continued)

### Loading / Unloading Machine







-  Prior to driving or winching vehicle on or off the machine make sure loading ramps are installed correctly.
-  When driving or winching a vehicle on or off machine, use helper to guide you. If vehicle's brakes are inoperable, use a Chief Winch and refer to instructions packaged with that accessory.
-  Immediately after positioning vehicle on mainframe, put vehicle in park (if automatic transmission), apply vehicles emergency brake, and have helper install wheel chocks at "front" of front tire and at "rear" of rear tire. Install wheel chocks as close to the tires as possible to prevent vehicle movement and keep wheel chocks installed whenever vehicle is not anchored to mainframe.
-  Position vehicle far enough onto mainframe so that wheels do not rest on loading ramps . DO NOT use ramps to lift or hold a load off of the floor. Remove ramps before raising machine.
-  Before lowering machine, put vehicle in park (if automatic transmission), apply vehicles parking brake, and install wheel chocks. Then check to make sure loading ramps are installed correctly.
-  DO NOT run over air hoses or hydraulic lines when loading or unloading vehicles.
-  DO NOT exceed the machine's 6,000 lbs. (2,722 kg.) lifting capacity.
-  When raising or lowering machine with vehicle aboard, DO NOT walk behind rear of machine.
-  Always install wheel chocks when raising or lowering machine with a vehicle aboard.

### Chain

-  The 1/2" tower chain is proof tested to 28,000 lbs. (124kN).

-  To avoid personal injury or damage to property, DO NOT:
  - Heat chain or hook while repairing vehicle. 600 degrees F (316 degrees C) of heat on chain will weaken it.
  - Tip load chain hook.
  - Pull with twisted chain links.

### Hydraulics

-  Keep foot pumps far away from excessive heat or flames. The surrounding temperature should not exceed 122° F (50° C).
-  Always release hydraulic pressure before disconnecting hydraulic hoses.
-  If pump fails to shut off, disconnect air supply and contact an authorized Chief Automotive Technologies Service Representative.
-  All components must be replaced with Chief Automotive Technologies authorized replacement parts.
-  Improper handling and/or modification of parts is for-bidden and may cause a hazardous situation for the user. Such action immediately voids the guarantee and releases the manufacturer from all liability.
-  Keep foot pump in upright position. DO NOT turn foot pump upside down or lay on its side.
- 
  1. Fill foot pump reservoir with all cylinders retracted. (See Maintenance Section - page 14.)
  2. DO NOT overfill foot pump reservoir.

### Operational Capacity

-  Qualified service personnel must check operational capacity of *impulse-Tilt* system prior to its initial use and at intervals of no more than one year. Contact Chief Automotive Technologies or contact your authorized Chief Automotive Technologies representative.

### Optional Steps / Ladders

-  Use only approved steps and ladders when working on or around this equipment.

## Hydraulic System Components

The hydraulic pneumatic foot pumps provided with the *impulse-Tilt* machine are reliable and efficient. One foot pump is provided for each tower that is installed.

The hydraulic pneumatic pump (see Figure 1) is a variable rate pressure device that delivers hydraulic oil under pressure through the use of compressed air as a power source. It is particularly useful in body shops where operators rely on hydraulic rams to not only lift vehicles but also to pull structural components into alignment.

### IMPORTANT:

Use hydraulic pneumatic foot pumps only for their intended purposes.

## Foot Pump Installation and Operation

Lay foot pump horizontally on ground (see Figure 2) and verify it is filled with oil.

### IMPORTANT:

Clean all oil ports of foot pump and ram. Inspect all threads and fittings for wear or damage and replace if needed. Clean all hose ends, couplers and union ends. Remove thread protectors from hydraulic fluid outlet port.

- 1 Apply teflon tape to threads of all fittings making certain it does not obstruct the flow of hydraulic oil. Figure 3 shows application of tape to restrictor orifice. Then secure restrictor orifice, 3/8 inch coupler and pressure gauge tee to foot pump's hydraulic output port. (See Figure 4.)
- 2 Attach pressure gauge to pressure gauge tee. (See Figure 5.) Then apply teflon tape to threads of 3/8 inch hydraulic hose and secure hose to pressure gauge tee. (See Figure 6.)

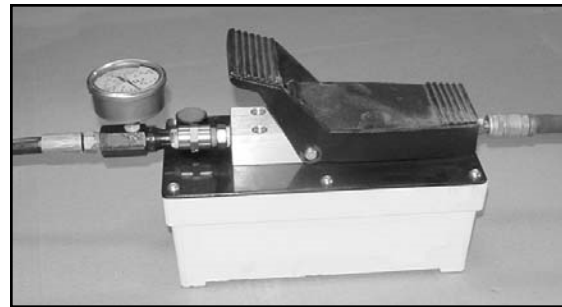

Figure 1

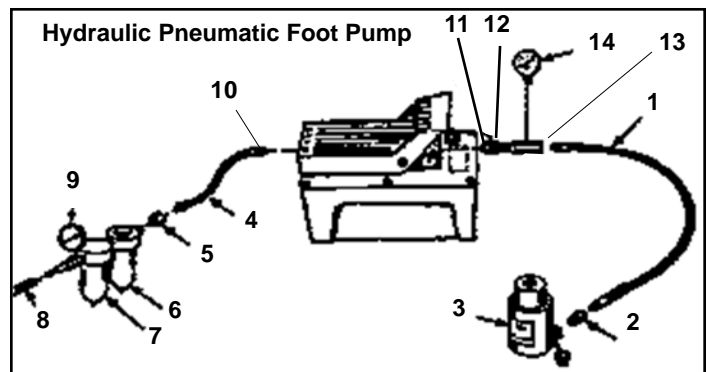

Figure 2

- |                          |                               |
|--------------------------|-------------------------------|
| 1 Hydraulic Hose         | 8 Air Supply (clean, dry)     |
| 2 Coupler                | 9 Inline Air Pressure Gauge * |
| 3 Single-Action Cylinder | 10 Air Coupler *              |
| 4 Air Hose *             | 11 Restrictor Orifice         |
| 5 Coupler                | 12 3/8" NPTF Coupler          |
| 6 Lubricator *           | 13 Pressure Gauge Tee         |
| 7 Filter *               | 14 Pressure Gauge             |

\* not provided

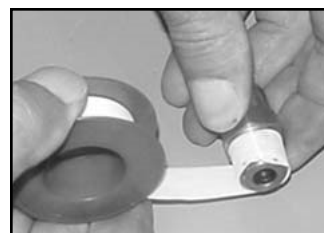

Figure 3

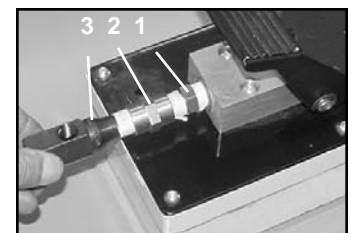

Figure 4

- |                      |
|----------------------|
| 1 Restrictor Orifice |
| 2 3/8" NPTF Coupler  |
| 3 Pressure Gauge Tee |



Figure 5

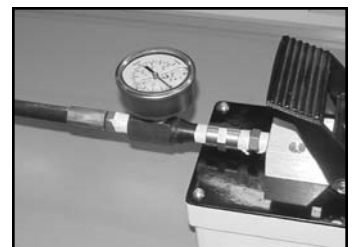

Figure 6



- 3 Apply Teflon tape to threads of 1/4 inch air coupler (see Figure 7) and secure air coupler to air input port (see Figure 8.).

**NOTE:** The compressed air inlet port is 1/4 inch NPTF. Air must be regulated, lubricated and filtered. A total of 115 PSI (8 bar) is recommended. Also, use a suitable quick connect. Install an automatic air line oiler in the air inlet line as close to the pumping unit as possible. It should feed approximately 1 drop of oil (SAE 10W) per minute.

- 4 Attach air hose to air coupler. (See Figure 9.)
5. Replace foot pump's air tight plug with breather plug. (See Figure 10.)
6. Attach foot pump's hydraulic hose to tower ram's quick coupler or to lift ram quick coupler. (See Figure 11.)
7. To operate foot pump, see page 6.

**IMPORTANT:** If hydraulic connections are not seated correctly, couplers may leak fluid or may not allow fluid to pass through. Male and female connectors must be fully seated and then tightly threaded together. Figure 12 shows a coupling that is not fully seated and Figure 13 shows a coupling that is fully seated.

**CAUTION:** To avoid personal injury or damage to property: When disconnecting hydraulic hose from quick coupler, some fluid spillage may occur. Always clean up any hydraulic fluid spillage from floor or work area.



Figure 7



Figure 8

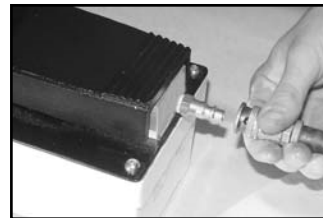

Figure 9



Figure 10



Figure 11

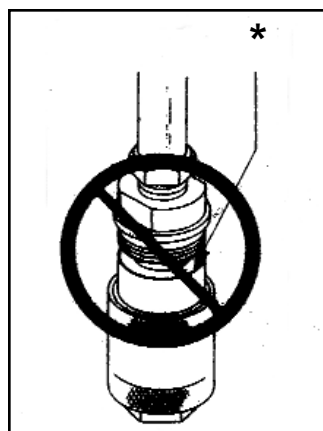

Figure 12

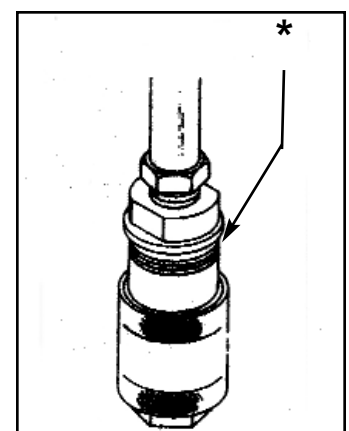

Figure 13

\* Male and female couplers are not fully seated. DO NOT thread them together.

\* Male and female couplers are fully seated and can be threaded together.



## Foot Pump Usage

### Foot Pedal

1. To activate foot pump, step on flat portion of foot pedal. (See Figure 14 — Arrow 1.) Pump will build hydraulic pressure and release it to hydraulic ram being operated.

**IMPORTANT:** DO NOT put excessive weight on pedal as it may damage foot pump.

2. To disengage foot pump, remove foot from pedal. This action stops flow of hydraulic oil to hydraulic ram being operated; however, it holds existing hydraulic pressure.

3. To release hydraulic pressure, step on angled portion of foot pedal (See Figure 14 — Arrow 2.) This action returns hydraulic oil to pump reservoir.

**CAUTION:** To prevent damage to foot pump and hydraulic ram, DO NOT operate pump when ram is fully extended. (If possible, stop supplying pressure before hydraulic ram reaches its full extension.)

### Priming The Pump

Occasionally, it may be necessary to prime the foot pump unit. To do this:

1. Press release pedal while simultaneously holding down air intake valve with flathead screwdriver. Air intake valve is located under flat portion of pedal. (See arrow — Figure 15.)
2. Allow foot pump to cycle approximately 15 seconds.
3. Remove screwdriver and press flat portion of pedal.
4. If ram extends or pressure builds, the foot pump has been successfully primed. If it doesn't, repeat procedure.

**IMPORTANT:** All air has been removed from hydraulic system at the factory, but if hydraulic system is opened to replace a system component, it is necessary to bleed air from the system prior to use. (See Maintenance Section - page 14.)

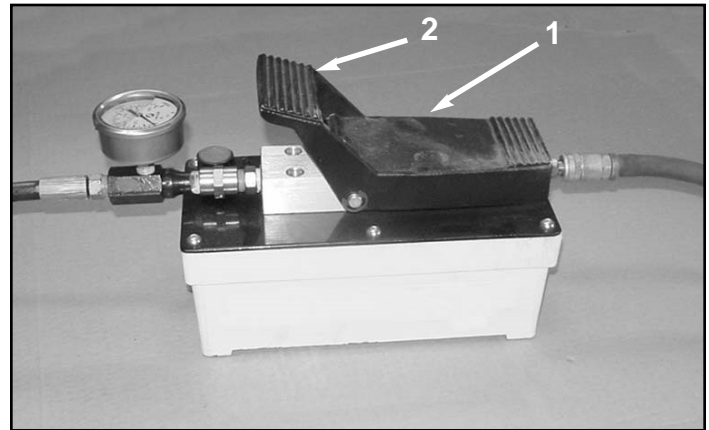
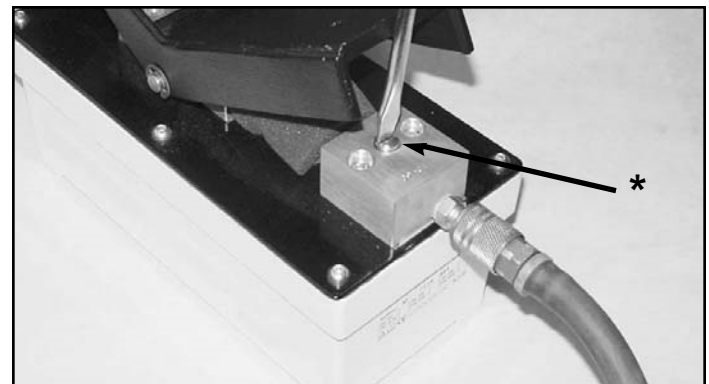

Figure 14

- 1 Flat Portion Of Foot Pedal
- 2 Angled Portion Of Foot Pedal



\* Air Intake Valve

Figure 15

**Red Circle**

When using more than one foot pump, the “red” circle on one of the pumps indicates that foot pump is for raising and lowering machine. (See Figure 16.) Use of a designated foot pump prevents displacement of hydraulic oil (one pump to the other) when pumps are alternately used to operate the lift. Use of a designated foot pump prevents the possibility of one pump overflowing while the other pump goes empty.

**NOTE:** The designated foot pump is not limited to just operating the lift, but may also be used for tower or auxiliary ram operation.

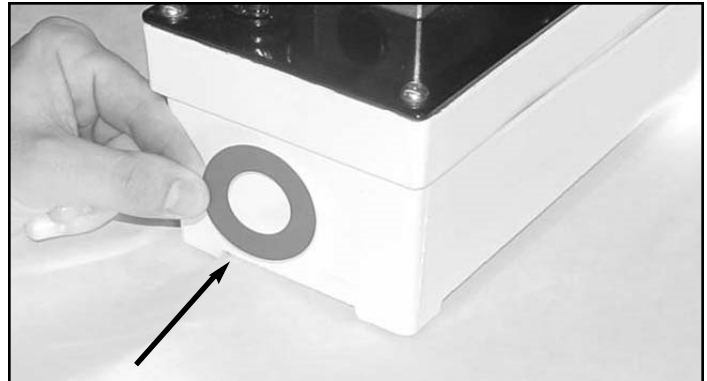

Figure 16

**Foot Pump Storage Rings**

Storage rings are provided that allow attachment of foot pumps to the towers. Foot pumps should only be attached when moving towers to another location and when not in use. To attach storage rings:

1. Lay storage ring along outer edge of mainframe making sure attachment leg extends downward. Then position foot pump within the storage ring. (See Figure 17.)

**IMPORTANT:** Position foot pump exactly as shown with hydraulic port to right side of attachment leg.

2. Pull storage ring upward to fit snug against body of foot pump. (See Figure 18.)

3. Insert storage strap below foot pump pedal. (See Figure 19.)

4. Attach storage strap to bracket using 1/4 x 20 x 2 1/2” socket head cap screws. (See Figures 20 and 21.)

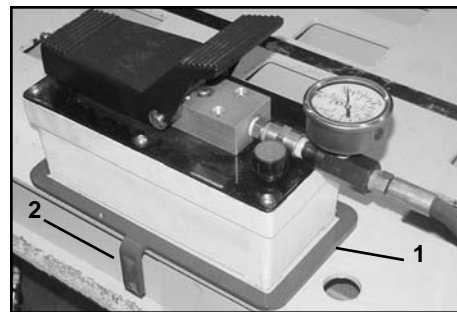

Figure 17

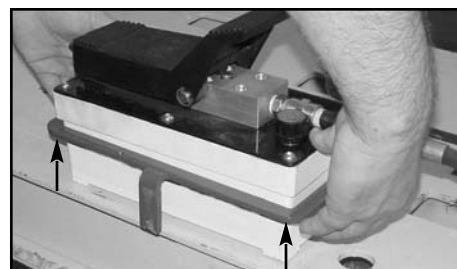

Figure 18



Figure 19



Figure 20

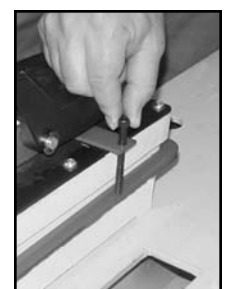

Figure 21

- Lift the assembly and insert attachment leg into bracket at bottom of tower. (See Figure 22 and its Inset.) **IMPORTANT:** Attach foot pump to tower for movement and storage purposes only. DO NOT operate foot pump from this location.

## Towers

The *impulse-Tilt* repair system is equipped with two pulling towers that can be positioned 360 degrees around the machine. The system can accommodate up to three additional towers. All towers feature telescoping heads, adjustable collars, and a unique roller assembly that not only secures the tower to the bottom of the machine but also allows for 360 degree movement around the machine.

Also unique to this system are the “Sure-Lock” force clamps that secure towers to circular pinning holes along the outer edge of the mainframe. The force clamps secure towers to the mainframe while removing stress from the roller assemblies.

Tower pulls can be set up quickly and are controlled by a foot pedal that governs the use of each tower’s air over hydraulic foot pump. Lateral and elevated pulling angles can be made or changed in just a fraction of a minute.

**CAUTION:** The 1/2 inch (13mm) tower chain is proof tested to 28,000 lbs. (124kN).

### To Operate Towers

- Step on “Sure-Lock” release handle to unlock “Sure-Lock” force clamp from mainframe. (See Figure 23.)
- Rotate “Sure-Lock” lock handle forward to fully open Sure-Lock. (See Figure 24.)
- Push tower to desired location on machine. (See Figure 25.)

**CAUTION:** When pushing tower, keep one hand on “Sure-lock” lock handle and other hand on tower pipe above collar. Also, keep hands away from all pinch points...i.e. roller assemblies on bottom of mainframe plate and force clamp pinning locations on top mainframe plate.

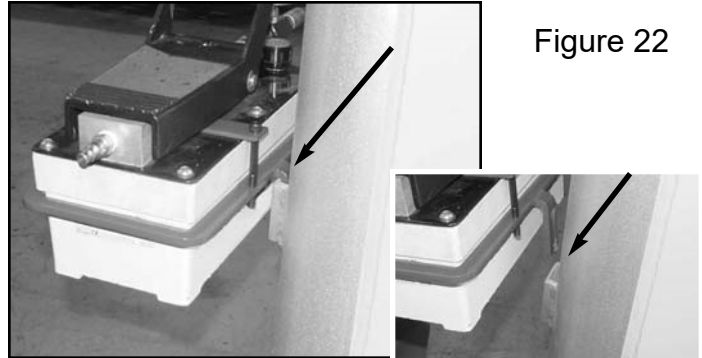

Figure 22



Figure 23



Figure 24



Figure 25

4. To secure tower to mainframe, rotate “Sure-lock” lock lever back and down to engage “Sure-Lock” force clamp with mainframe pinning hole. (See Figure 27.) Fully lock “Sure-Lock” by stepping on lock lever. “Sure-Lock” force clamp is fully engaged when outer tower rollers are raised above the outer track. (See Figure 26.)



Figure 26

**WARNING**

Fully engage “Sure-Lock” force clamp with pinning hole on mainframe to prevent tower movement during the pull or during a raising or lowering procedure.

**CAUTION:** When engaging “Sure-Lock” force clamp, keep hands away from all pinch points...i.e. roller assemblies on bottom mainframe plate and force clamp pinning location on top mainframe plate.

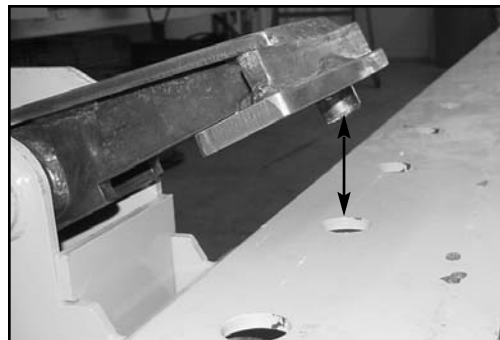

Figure 27

5. To adjust slack tower chain, grip chain on each side of the tower. Lift out on tail of chain until it is approximately 45 degrees from tower. Then disengage chain from tower head and pull chain to either increase or decrease amount of slack. (See Figure 28.)
6. Support collar with one hand while loosening collar locking knob with opposite hand. Then position collar approximately 3 inches (75mm) above desired pulling height and retighten collar locking knob. (See Figure 29.)
7. Let tower chain hang free momentarily to remove twist. Then without twisting chain, attach hook to the vehicle. Pull on tail end of chain to remove slack (see Figure 30) and then lower collar.

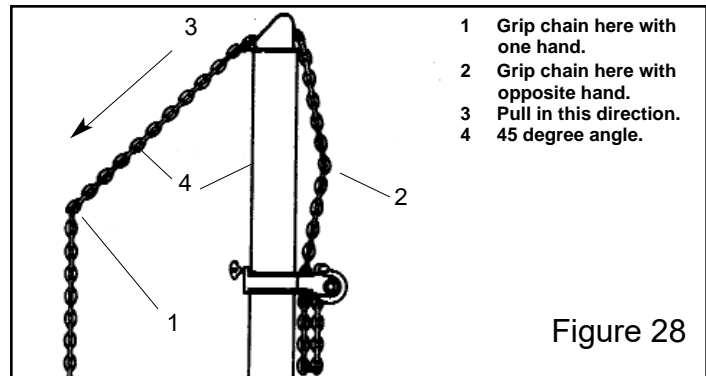

Figure 28

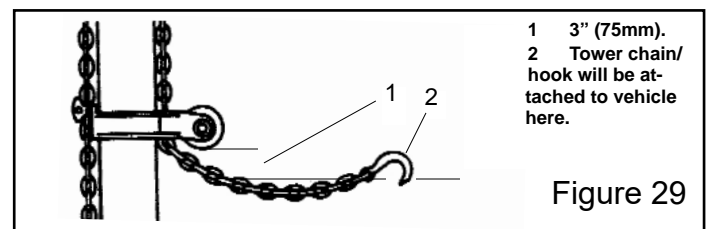

Figure 29

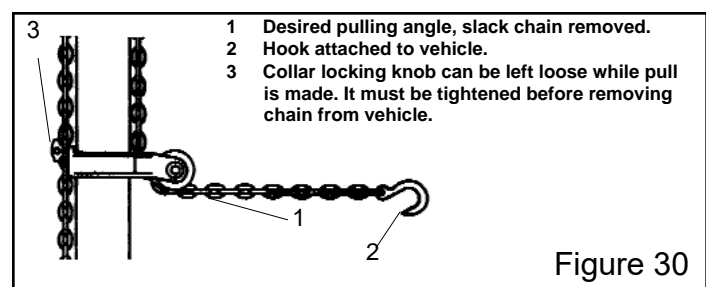

Figure 30



7. Attach foot pump's hydraulic hose to tower ram's quick coupler. (See Figure 31.)
8. To operate foot pump, follow usage procedures on page 6.

**CAUTION:**

1. To prevent damage to tower assembly, pulls must not exceed a 45 degree angle from tower base. (See Figure 32.)
2. To avoid personal injury or damage to equipment, DO NOT:
  - Heat chain hook while repairing vehicle. 600 degrees F (316 degrees C) of heat on chain will weaken it.
  - Tip load chain hook.
  - Pull with twisted chain links.



Figure 31

**Warning**

To avoid severe personal injury to yourself and others: DO NOT position yourself close to, or in line with chains, clamps, or other accessories while pressure is applied to this system.

**IMPORTANT:**

1. DO NOT tighten collar locking knob while pressure is applied to system because it will be impossible to loosen the knob without pressure on the system. If it has been tightened by error while pressure is on the system, reapply pressure and loosen the knob.
2. DO NOT wrap tower chain around track nor attach tower hook to track. Damage to track will impede tower usage.

9. When tower is no longer needed, disconnect foot pump's hydraulic hose from tower ram's quick coupler, remove tower chain and hook from vehicle and store collar using one of the three methods shown in Figures 33, 34 and 35.

**CAUTION:**

1. Collar locking knob must be tightened before removing tower chain and hook from vehicle.
2. Collar locking knob must be tight when collar is not in use.
3. Store collar at bottom of tower pipe or support collar with tower chain.

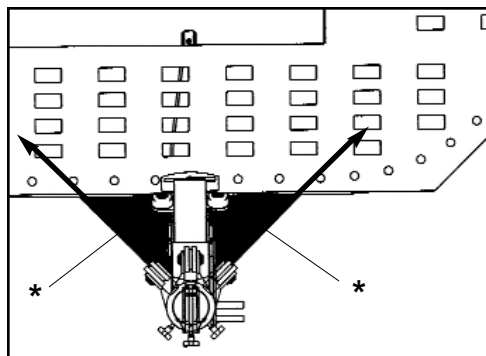

\* Pulling Angle Must Not Exceed 45 Degree Range From Tower Base.

Figure 32

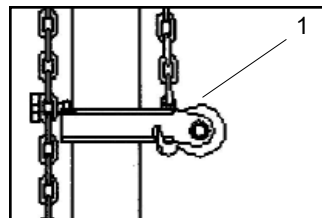

Figure 33

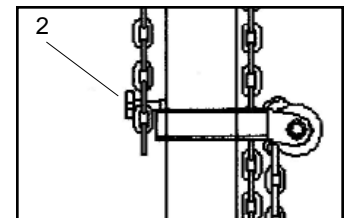

Figure 34

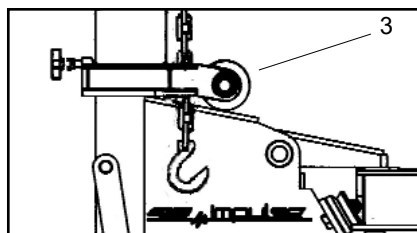

Figure 35

- 1 Collar supported by Tower Chain.
- 2 When collar and chain are stored this way, collar locking knob must be tightened before removing tower chain and hook from vehicle.
- 3 Collar rests on tower base.

## Optional Crossmember

An optional crossmember is available for the *impulse-Tilt* system. The crossmember (see Figure 36) mounts to the inside edges of the treadway and can be moved forward or rearward as needed. The crossmember does not lock to the machine; however, support pins (see Figure 38) pre-vent it from being accidentally disengaged.

The primary use of the crossmember is to support perpendicular pulls and pushes. In both instances, the auxiliary ram must be positioned perpendicular with top or bottom of crossmember.

To install the crossmember, hold it secure while rotating it into position. (See Figure 37.) Both ends of the crossmember must engage top mainframe plate. Then secure support pins (see Figure 38) at each end of the crossmember.

### CAUTION:

1. DO NOT use movable crossmember as a step.
2. DO NOT use movable crossmember as a base to make a hydraulic pull or push unless auxiliary ram is positioned perpendicular (90 degrees) with top or bottom of crossmember.
3. Each time crossmember is removed from mainframe and reinstalled, reinstall support pins at each end of the crossmember to prevent accidental disengagement.
4. DO NOT make angular pulls or pushes from the crossmember.

## Reverse Usage - Optional Crossmember

If additional height is required for lifting high ground clearance vehicles, the crossmember can be turned upside down to provide a higher platform. (See Figure 39.) Bridging the treadways in this fashion provides an additional 5 inches of height.

 **CAUTION:** When crossmember is installed as shown in Figure 39, use extreme caution.

1. Use this setup only when mainframe is in level position.
2. Center crossmember evenly from side to side.
3. Remove crossmember before lowering machine.
4. Use this setup for perpendicular lifting only. DO NOT use this setup for any type of pull.
5. DO NOT position yourself close to or underneath the crossmember when lifting the vehicle.

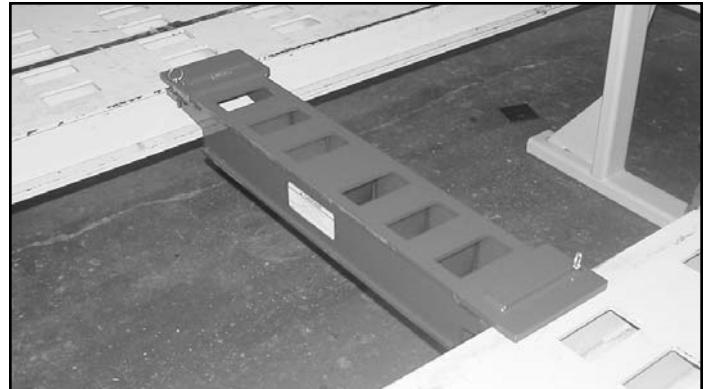

Figure 36



Figure 37

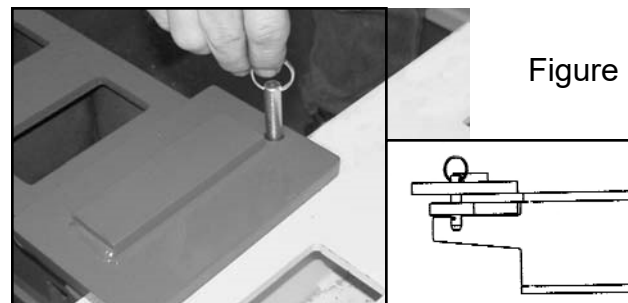

Figure 38

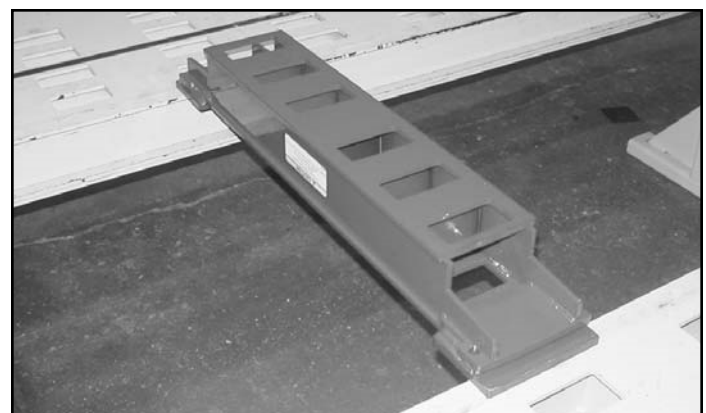

Figure 39

## Lowering / Raising Machine

When lowering or raising a machine with a vehicle aboard observe the following precautions.

### CAUTION:

1. When driving or winching vehicle on or off machine, use a helper to guide you. (See Figure 40.) If vehicle's brakes are inoperable, use a Chief Winch and refer to instructions packaged with that accessory.
2. When vehicle is on mainframe, all wheels must clear the loading ramps. (See Figure 41.) DO NOT attempt to lift machine with vehicle's wheels on the loading ramps. Remove ramps before raising machine.
3. Immediately after positioning vehicle on mainframe, put vehicle in park (if automatic transmission), and apply vehicles emergency brake. Continue to press brake pedal until helper installs wheel chocks (see Figure 42) at "front" and "rear" of rear tires.
4. Prior to lowering machine, put vehicle in park (if auto-matic transmission), apply vehicles emergency brake, and install wheels chocks at "front" and "rear" of rear tires. Then install loading ramps at rear of machine.
5. Keep vehicles wheels blocked during raising and lowering procedures and whenever vehicle is not anchored to mainframe.
6. When raising or lowering machine with vehicle aboard, DO NOT walk behind machine.
7. DO NOT exceed 6,000 lbs. (2,722 kg) lifting capacity of *impulse-Tilt* system.



Figure 40

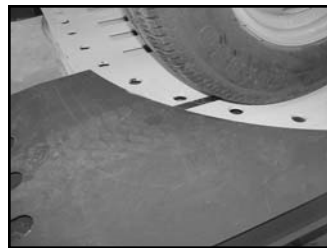

Figure 41



Figure 42

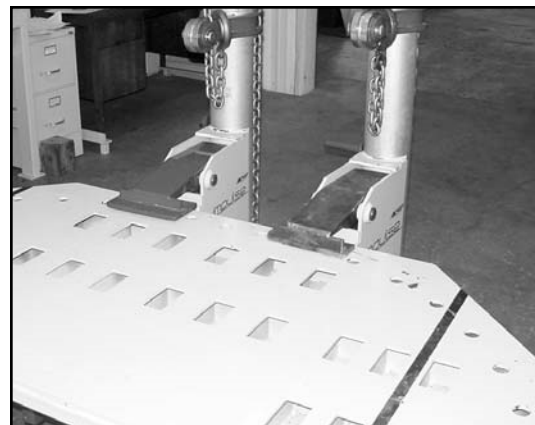

Figure 43

## To Lower Machine

**IMPORTANT:** Observe preceding precautions when lowering machine with vehicle aboard.

1. Position towers at front of machine and secure the "Sure-Lock" force clamps to front pinning holes. (See Figure 43.)
2. Install loading ramps at rear of machine. (See Figure 44.)

**NOTE:** Loading Ramp pins must engage loading ramp pinning holes at rear corners of machine. (See Inset.)

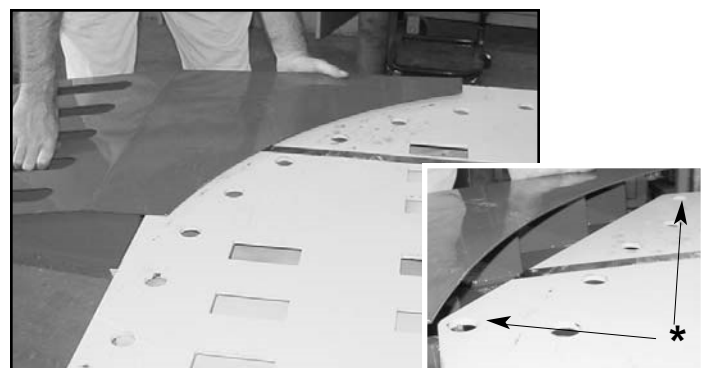

Figure 44

\* Loading Ramp Pinning Holes On Mainframe



3. Attach foot pump's hydraulic hose to lift ram's quick coupler. (See Figure 45.)

**IMPORTANT:** Use foot pump with red identification circle. Use of a designated foot pump for raising and lowering machine prevents displacement of hydraulic fluid (one foot pump to the other) when pumps are alternately used to raise and lower machines.

4. Raise machine until stiff leg is off floor and swing stiff leg assembly out of the way. (See Figures 46 and 47.)

5. Lower rear of machine to floor. For this procedure, activate foot pump by hand.

**CAUTION:**

- 1. Before lowering machine, clear all obstacles from under and around machine.
- 2. DO NOT allow anyone or anything to ride on machine or be under machine during lowering procedures.



Figure 45

**To Raise Machine**

**IMPORTANT:** Observe preceding precautions when raising machine with vehicle aboard. (See top of page 12.)

1. Attach foot pump's hydraulic hose to lift ram's quick coupler. (See Figure 45.)

**IMPORTANT:** Use foot pump with red identification circle. Use of a designated foot pump for raising and lowering machine prevents displacement of hydraulic fluid (one foot pump to the other) when pumps are alternately used to raise and lower machines.

2. Raise machine until stiff leg swings into upright (perpendicular) position.

3. Lower machine until stiff leg assembly is secure on the floor.

**CAUTION:**

- 1. Before raising machine, clear all obstacles from under and around machine.
- 2. DO NOT allow anyone or anything to ride on machine or be under machine during lowering procedures.

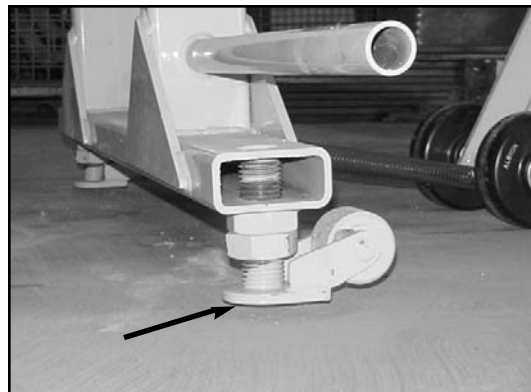

Figure 46



Figure 47

## Machine Maintenance

### Check And Inspect

These components should be checked prior to use and anytime a problem is suspected.

 **CAUTION:** To avoid personal injury when performing any maintenance function, always wear safety glasses and safety shoes.

### Tower Chains, Tie-Down Chains

1. Clean chain before inspecting.
2. Inspect each link for wear, nicks, gouges, stretched or bent links. If found, replace chain.
3. Inspect tower hooks for twist and stretched openings. If found replace chain.

 **CAUTION:** To avoid personal injury or damage to property, DO NOT:

- Heat chain or hook while repairing vehicle. 600 degrees F (316 degrees C) of heat on chain will weaken it.
- Tip load chain hook.
- Pull with twisted chain links.

### Tower Track And Tower Roller Wheels

Inspect inside and outside tower tracks. Blow or brush dirt and debris from tracks.

Inspect inside and outside tower roller wheels for damage. The inside and outside roller bearings are lubrication free. Use compressed air to clean. DO NOT lubricate.

### Loading Ramps

Inspect loading ramps making sure loading ramp pins mate with pinning holes at rear of machine each time mainframe is raised or lowered.

### Power and Control Cords

Inspect hydraulic hoses and air hoses for leaks or other damage. If found, replace hose(s).

### Cleaning and Lubricating

Clean and lubricate these components as specified for trouble free and extended service. When lubricating use the following:

Oil — Use 30 weight motor oil for all components requiring oil.

Grease — Use a SUS750 Lithium type grease such as lubricate #630-2 for all components requiring grease.

### Lift Assembly / Stiff Leg Assemblies

Clean dirt and grease from all pivot points and lubricate every two months.

### Collars

Clean and lubricate collars monthly.

1. Use compressed air to blow out dirt or dust that collects between collar ears and rollers.

 **CAUTION:** Wear safety glasses while using compressed air to blow out dirt and dust.

2. Place a few drops of oil on roller pin between roller and collar ears (each side). Then turn roller a few times. Roller must turn freely.

### Tower Heads

Clean tower heads every six months.

1. Remove tower chain from tower head.
2. Remove tower head from tower pipe.
3. Clean dirt from tower head pipe and where tower head pipe rubs on inside of tower pipe.
4. Reinstall tower head and tower chain.

### Eliminating Air In Hydraulic System

All air has been removed from hydraulic system at the factory, but if hydraulic system is opened to replace a system component, it is necessary to bleed air from system prior to using it.

### Bleeding Air In System At Quick Coupler

1. Separate quick coupler.
2. Place male end of quick coupler in container and hold rag over container and quick coupler.

 **CAUTION:** Wear safety glasses to protect eyes from hydraulic oil in the event it squirts out of container and past the rag.

3. Depress ball check at end of quick coupler against bottom of container.

 **CAUTION:** DO NOT have any pressure on the system when pressing ball check on quick coupler.

4. Press forward on foot pump to pump air out of system and continue until only hydraulic oil is being pumped out.
5. Reconnect quick coupler.
6. Refill hydraulic fluid reservoir as per manufacturer's recommendations packaged with foot pump.

### Bleeding Air From System Beyond Quick Coupler

Contact an authorized Chief Automotive Technologies Service representative.

### Refill Hydraulic Fluid Reservoir

The hydraulic pneumatic foot pump contains 1.7 liters of hydraulic oil. When refilling reservoir or adding oil, fill to within ½" (13mm) of top using SUS215 viscosity @ 100° F (38° C) 10W hydraulic oil.

 **CAUTION:**

1. Fill foot pump reservoir with all cylinders retracted.
2. DO NOT overfill foot pump reservoir.

## ***impulse-Tilt* Specifications**

Weight.....	3,700 lbs. (1,678kg.)
Power Required.....	115 psi Air Supply (8.0 Bar)
Hydraulic Power.....	10,000 psi (690 Bar) hydraulics
Hydraulic Fluid.....	1.7L-SUS 215 Viscosity 100 degrees F (38 degrees C) 10w Hydraulic Fluid
Radius Of Pull.....	360 degrees
Controls.....	Air-Over-Hydraulic Foot Pump
Deck Length.....	18' (5.5m) 19' 8" (6.0m) with ramps 21' 8" (6.6m) maximum length with towers at one end with ramps installed 22' (6.7m) with towers to both ends
Width.....	6' 9" (2m) 10' 8" (3.2m) with towers extend ed to both sides
Width Of Treadways.....	23 3/8" (.6m)
Width Between Treadways.....	33 1/2" (.85m)
Tower Height.....	7' 6" (2.28m)
Clearance.....	2' 2' (.6m) recommended on all sides
Working Height.....	26 1/2" (.67m) from floor to top of mainframe
Tie Down Openings.....	172 (178 with optional crossmember)
Lift Capacity.....	6,000 lbs. (2,722kg.)
Sound Pressure Level At Control Position.....	81 dB(A)

**Optional:** Removable Crossmember, Additional Towers (3)

***impulse-Tilt* Hydraulic / Pneumatic Diagram**

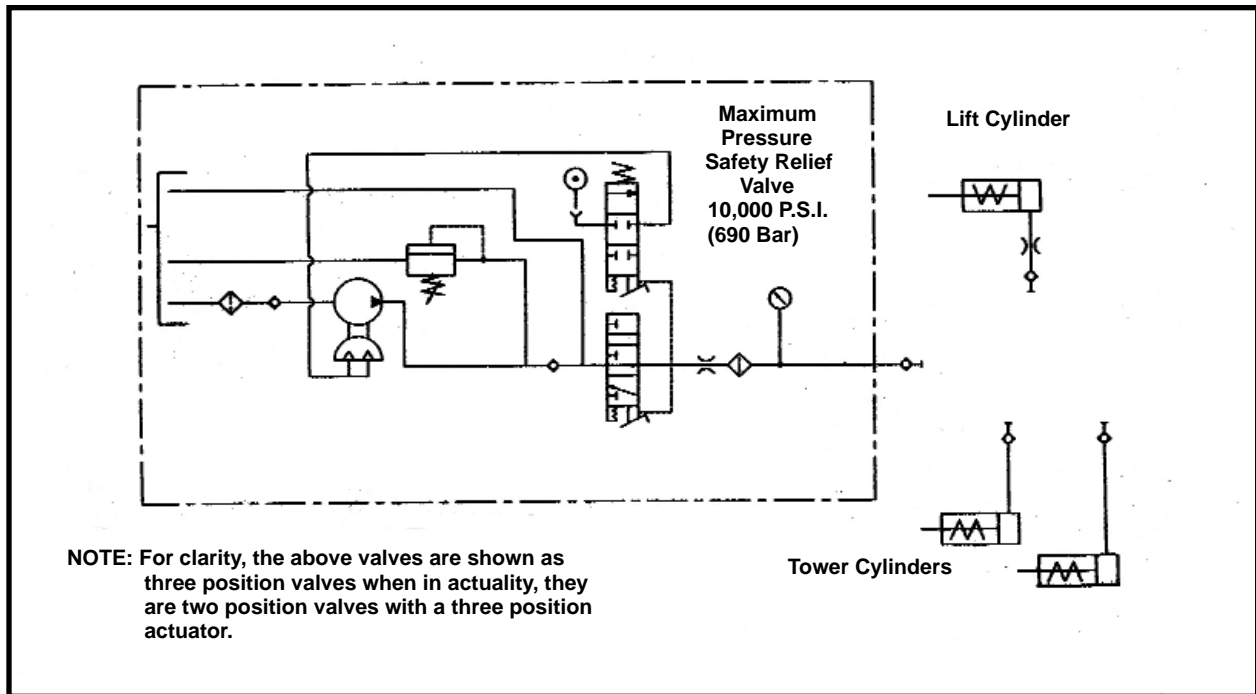



**996 Industrial Drive  
Madison, Indiana 47250  
Phone: 800.445.9262  
Fax: 866.275.0173**

**[www.chiefautomotive.com](http://www.chiefautomotive.com)**

**Chief reserves the right to alter product specifications  
and/or package components without notice.**